



US00D862901S

(12) **United States Design Patent** (10) **Patent No.:** **US D862,901 S**
Xavier et al. (45) **Date of Patent:** **** Oct. 15, 2019**

- (54) **FERRULE FOR COSMETIC BRUSH**
- (71) Applicant: **Sigma Enterprises, LLC**, Mendota Heights, MN (US)
- (72) Inventors: **Simone Rodrigues Oliveira Xavier**, Fort Lauderdale, FL (US); **Rene Xavier Filho**, Fort Lauderdale, FL (US)
- (73) Assignee: **Sigma Enterprises, LLC**, Mendota Heights, MN (US)
- (**) Term: **15 Years**
- (21) Appl. No.: **29/643,451**
- (22) Filed: **Apr. 9, 2018**
- (51) **LOC (12) Cl.** **04-02**
- (52) **U.S. Cl.**
USPC **D4/199**
- (58) **Field of Classification Search**
USPC D4/121, 127, 135, 138; 15/106, 159.1, 15/160, 176.1, 184, 190-194; 132/289, 132/294, 298, 313, 317, 320; 401/123, 401/141, 175, 281
CPC A46B 7/026; A46B 5/005; A46B 17/04; A46B 2200/1046
See application file for complete search history.

- D449,932 S * 11/2001 Ancona D4/199
 - D479,917 S 9/2003 Mink
 - D479,918 S 9/2003 Mink
 - D562,566 S 2/2008 Mink
 - D571,559 S 6/2008 Riaz
 - D572,010 S 7/2008 Riaz
 - D625,522 S 10/2010 Riaz
 - D628,811 S 12/2010 Masuyama
 - 7,895,698 B2 3/2011 Mink
- (Continued)

Primary Examiner — Austin Murphy
(74) *Attorney, Agent, or Firm* — Dorsey & Whitney LLP

(57) **CLAIM**

We claim the ornamental design for a ferrule for cosmetic brush, as shown and described.

DESCRIPTION

FIG. 1 is an isometric view of a ferrule for cosmetic brush with a brush handle and bristles dashed to show environment.

FIG. 2 is an isometric view of the ferrule for cosmetic brush, showing our new design.

FIG. 3 is a front elevation view of the ferrule for cosmetic brush.

FIG. 4 is a rear elevation view of the ferrule for cosmetic brush.

FIG. 5 is a right side elevation view of the ferrule for cosmetic brush.

FIG. 6 is a left side elevation view of the ferrule for cosmetic brush.

FIG. 7 is a top plan view of the ferrule for cosmetic brush; and,

FIG. 8 is a bottom plan view of the ferrule for cosmetic brush.

The dashed lines in FIG. 1 illustrate environment and form no part of the claimed design. The dashed lines in FIGS. 2-8 illustrate unclaimed portions of the ferrule for cosmetic brush that form no part of the claimed design.

1 Claim, 4 Drawing Sheets

- (56) **References Cited**
U.S. PATENT DOCUMENTS
- 1,468,716 A * 9/1923 Kersting A46B 9/08
16/108
- 3,751,751 A 8/1973 Karl
- 4,088,413 A 5/1978 Rossignol de la Ronde et al.
- D249,600 S 9/1978 Bowman
- D278,951 S 5/1985 Kalinsky
- D278,952 S 5/1985 Kalinsky
- D304,392 S 11/1989 Reich
- D385,476 S 10/1997 Hill
- D448,642 S 10/2001 Hermann
- 6,308,371 B1 10/2001 Forsline

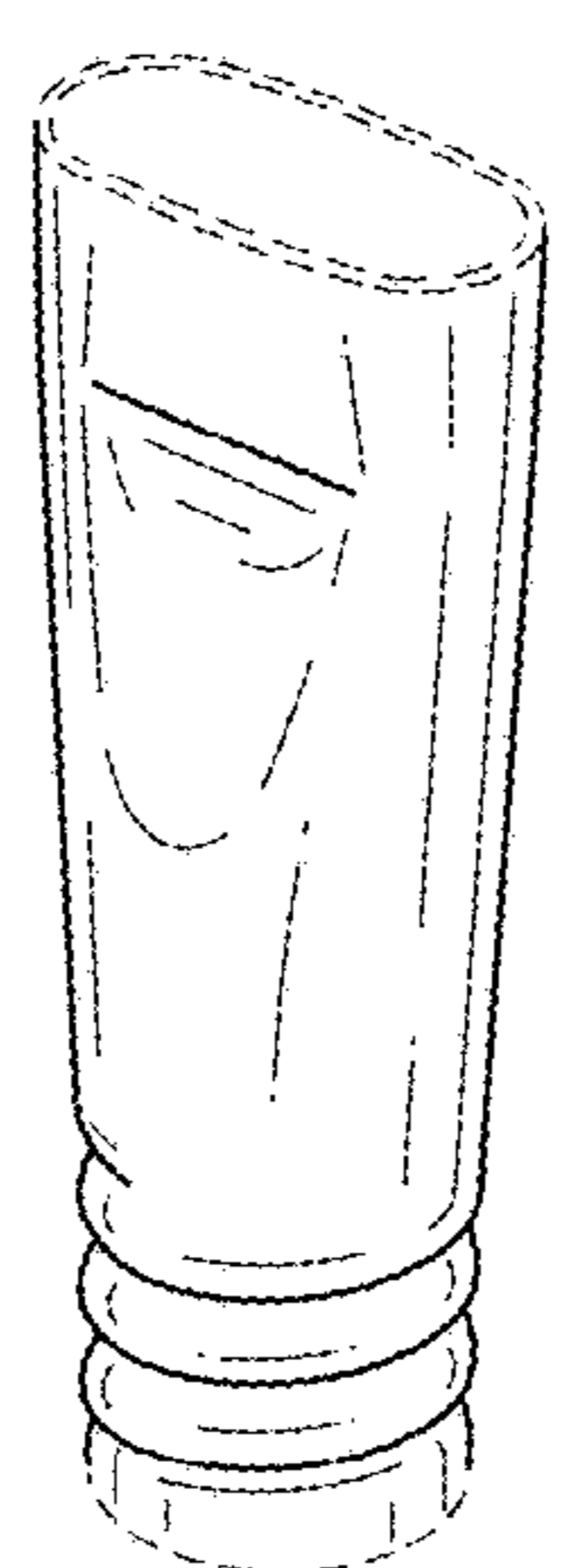

(56)

References Cited

U.S. PATENT DOCUMENTS

D658,385	S	5/2012	Lim et al.	
8,230,543	B2	7/2012	Shrier et al.	
D718,060	S	11/2014	Filho et al.	
D735,382	S *	7/2015	Blanchette	D26/38
D749,859	S *	2/2016	Snook	D4/135
D762,070	S *	7/2016	Katsuma	D4/199
D768,998	S *	10/2016	Kim	D4/127
D778,623	S *	2/2017	Jain	D4/199
D808,661	S *	1/2018	Jain	D4/199
D825,936	S *	8/2018	Hwang	D4/199
2001/0042281	A1	11/2001	Forsline	
2005/0133947	A1	6/2005	Jang	
2005/0257337	A1	11/2005	Clegg et al.	
2006/0248669	A1	11/2006	Dovello	
2008/0141479	A1	6/2008	Mink	
2009/0183328	A1	7/2009	King	
2010/0095973	A1	4/2010	Shrier et al.	
2013/0098382	A1	4/2013	Martin et al.	

* cited by examiner

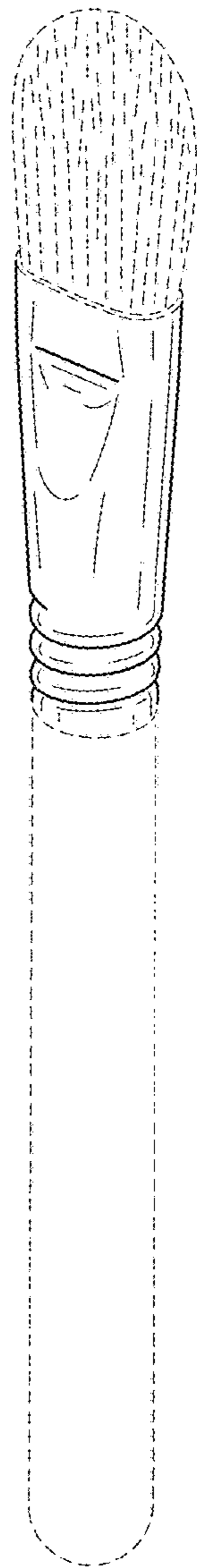

FIG. 1

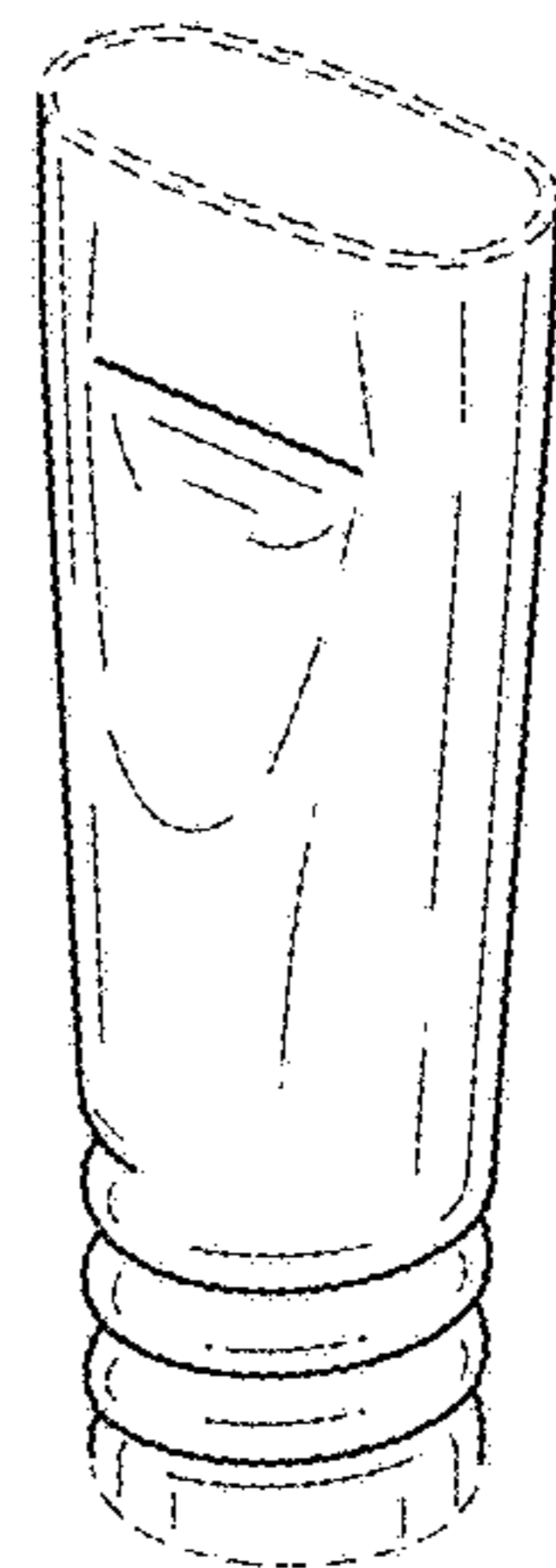

FIG. 2

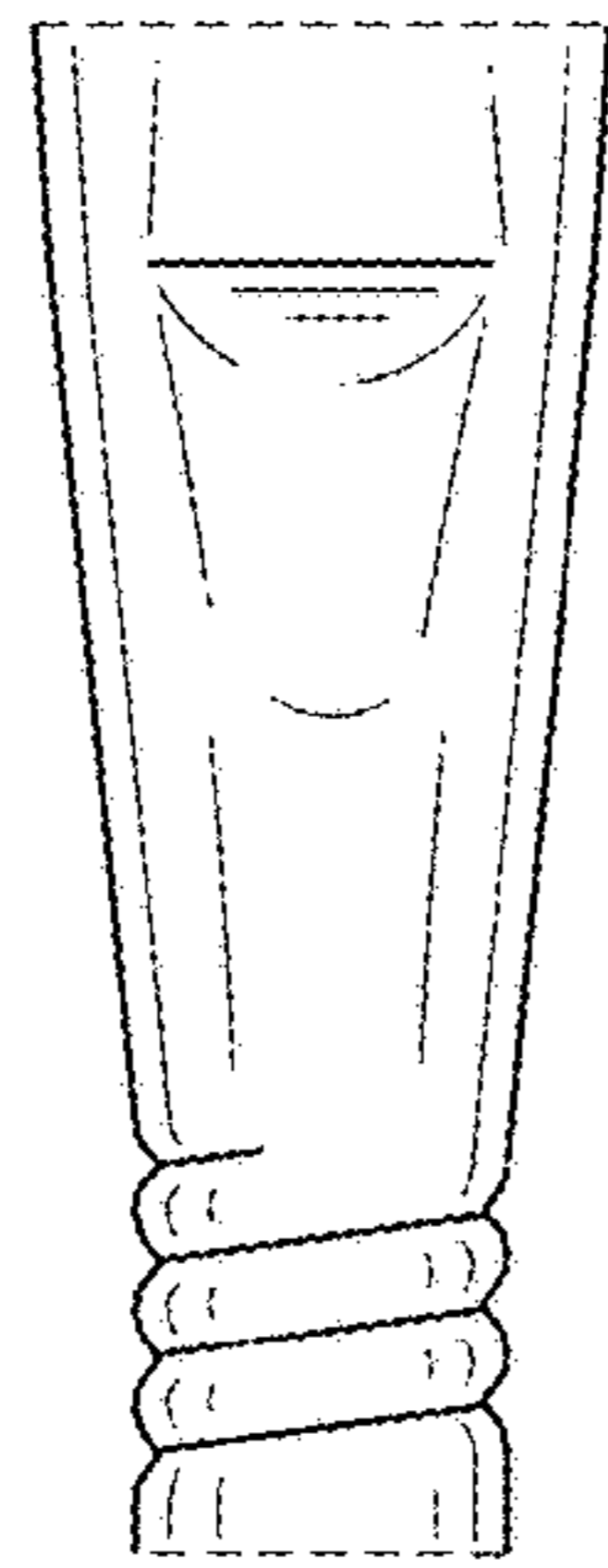

FIG. 3

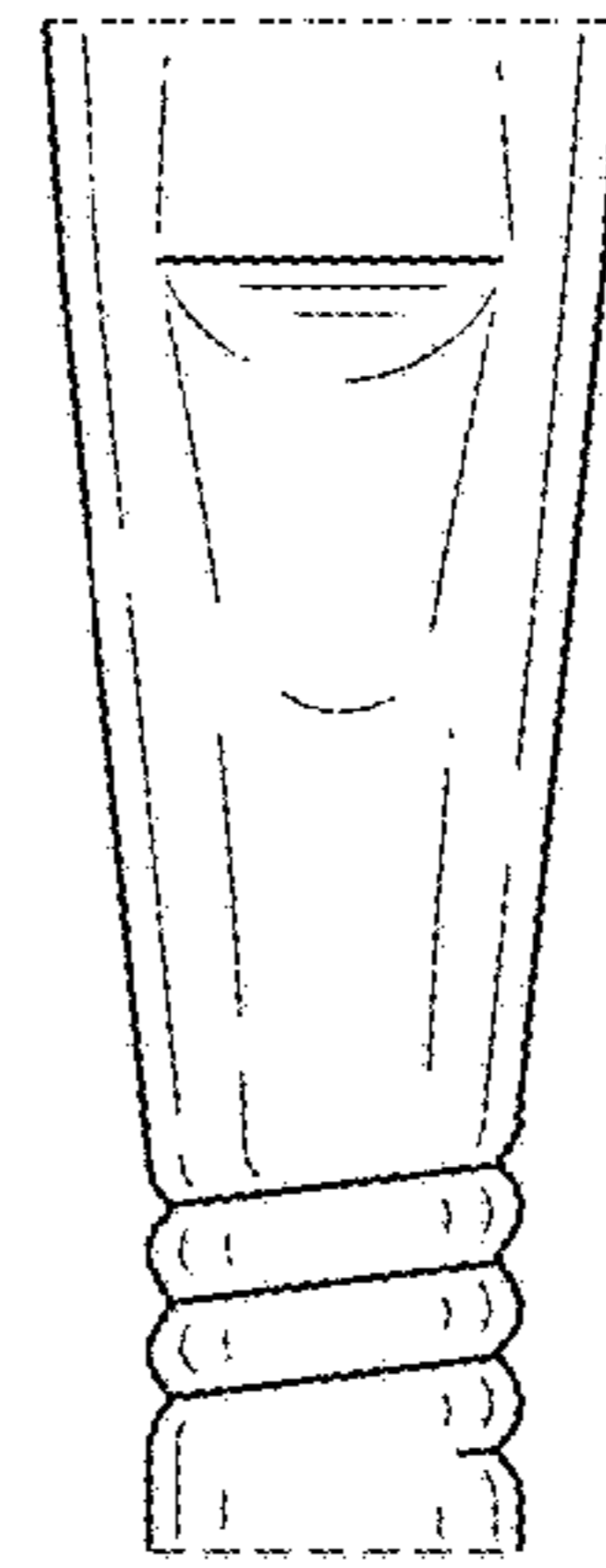

FIG. 4

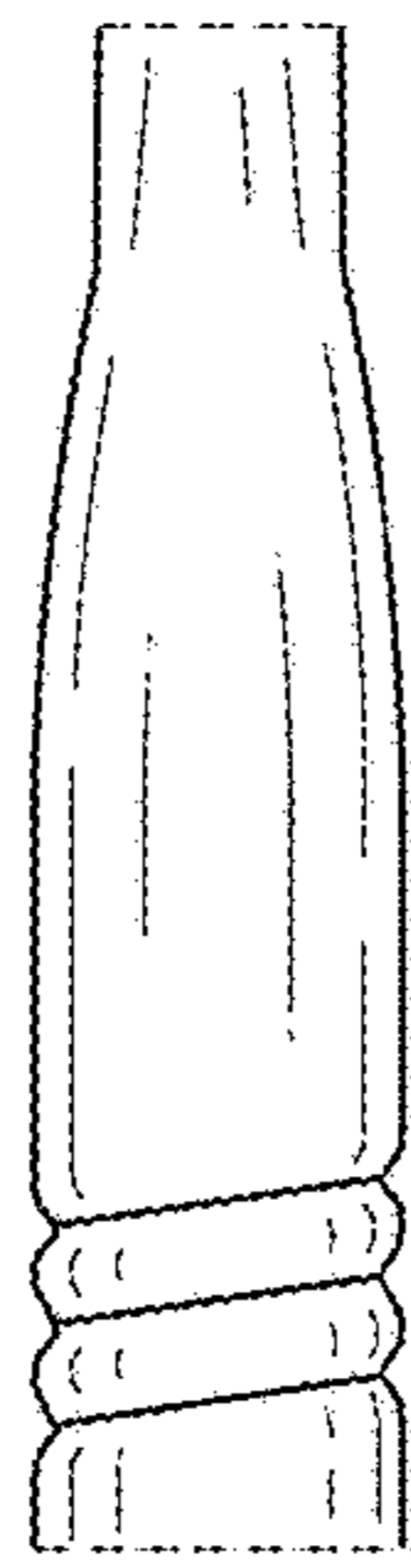

FIG. 5

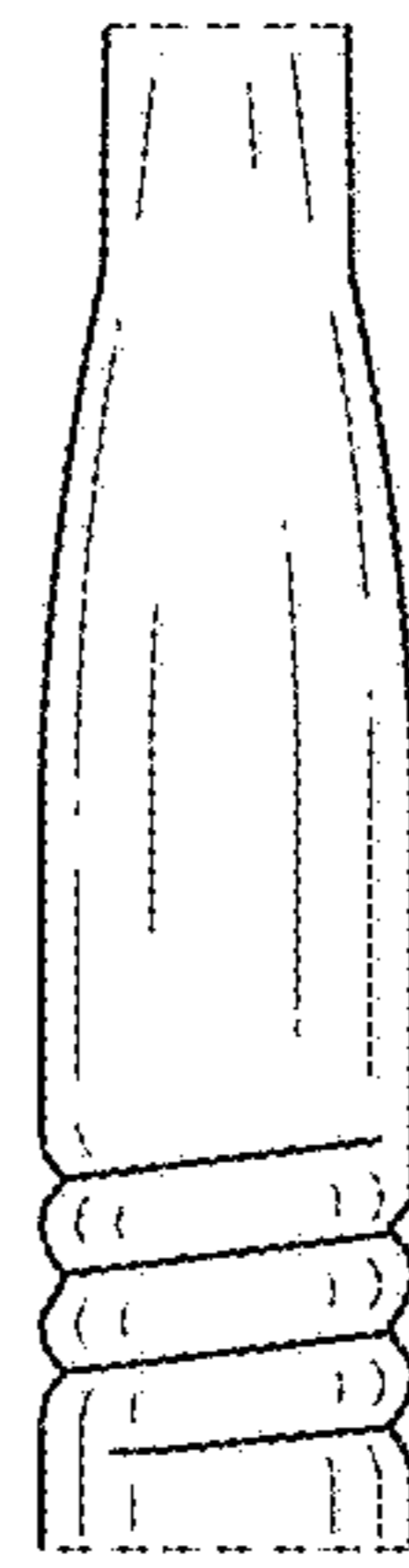

FIG. 6

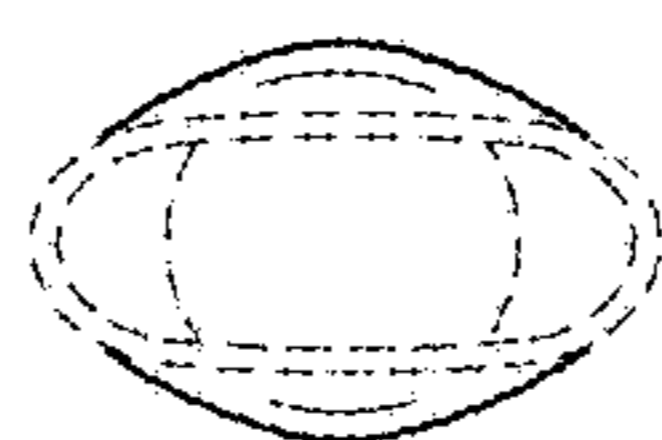

FIG. 7

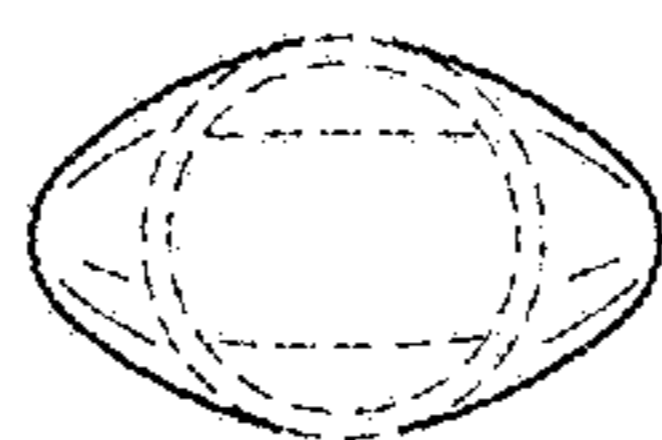

FIG. 8