



US00D862889S

(12) **United States Design Patent**  
**Dolce et al.**

(10) **Patent No.:** **US D862,889 S**

(45) **Date of Patent:** **\*\* Oct. 15, 2019**

(54) **HANDLE APPLIED TO HANDBAG**

D825,927 S \* 8/2018 Solveson ..... D3/318

(71) Applicant: **DOLCE & GABBANA S.r.l.**, Milan (IT)

\* cited by examiner

(72) Inventors: **Domenico Dolce**, Milan (IT); **Stefano Gabbana**, Milan (IT)

*Primary Examiner* — Holly H Baynham

(73) Assignee: **DOLCE & GABBANA S.r.l.** (IT)

(74) *Attorney, Agent, or Firm* — Saidman DesignLaw Group, LLC

(\*\*) Term: **15 Years**

(57) **CLAIM**

(21) Appl. No.: **29/656,269**

The ornamental design for a handle applied to handbag, as shown and described.

(22) Filed: **Jul. 11, 2018**

(30) **Foreign Application Priority Data**

**DESCRIPTION**

Jan. 12, 2018 (EM) ..... 004663813

(51) **LOC (12) Cl.** ..... **03-01**

(52) **U.S. Cl.**  
USPC ..... **D3/318**

(58) **Field of Classification Search**  
USPC ..... D3/232–233, 240–243, 245–246.318  
CPC ..... A45F 5/10; A45F 5/14  
See application file for complete search history.

FIG. 1 is a front perspective view of a handle applied to handbag showing our new design;  
FIG. 2 is a front view thereof;  
FIG. 3 is a rear view thereof;  
FIG. 4 is a top view thereof;  
FIG. 5 is a bottom view thereof;  
FIG. 6 is a right side view thereof;  
FIG. 7 is a front perspective view thereof in an alternate position;  
FIG. 8 is a left side view thereof;  
FIG. 9 is a front view thereof; and,  
FIG. 10 is a rear view thereof.

(56) **References Cited**

**U.S. PATENT DOCUMENTS**

833,101 A \* 10/1906 Wlghard ..... A45C 3/06  
150/107  
D634,543 S \* 3/2011 Scicluna ..... D3/318  
D799,832 S \* 10/2017 Tong ..... D3/318

The broken lines illustrate structure or features which form no part of the claimed design.

**1 Claim, 6 Drawing Sheets**





FIG. 1

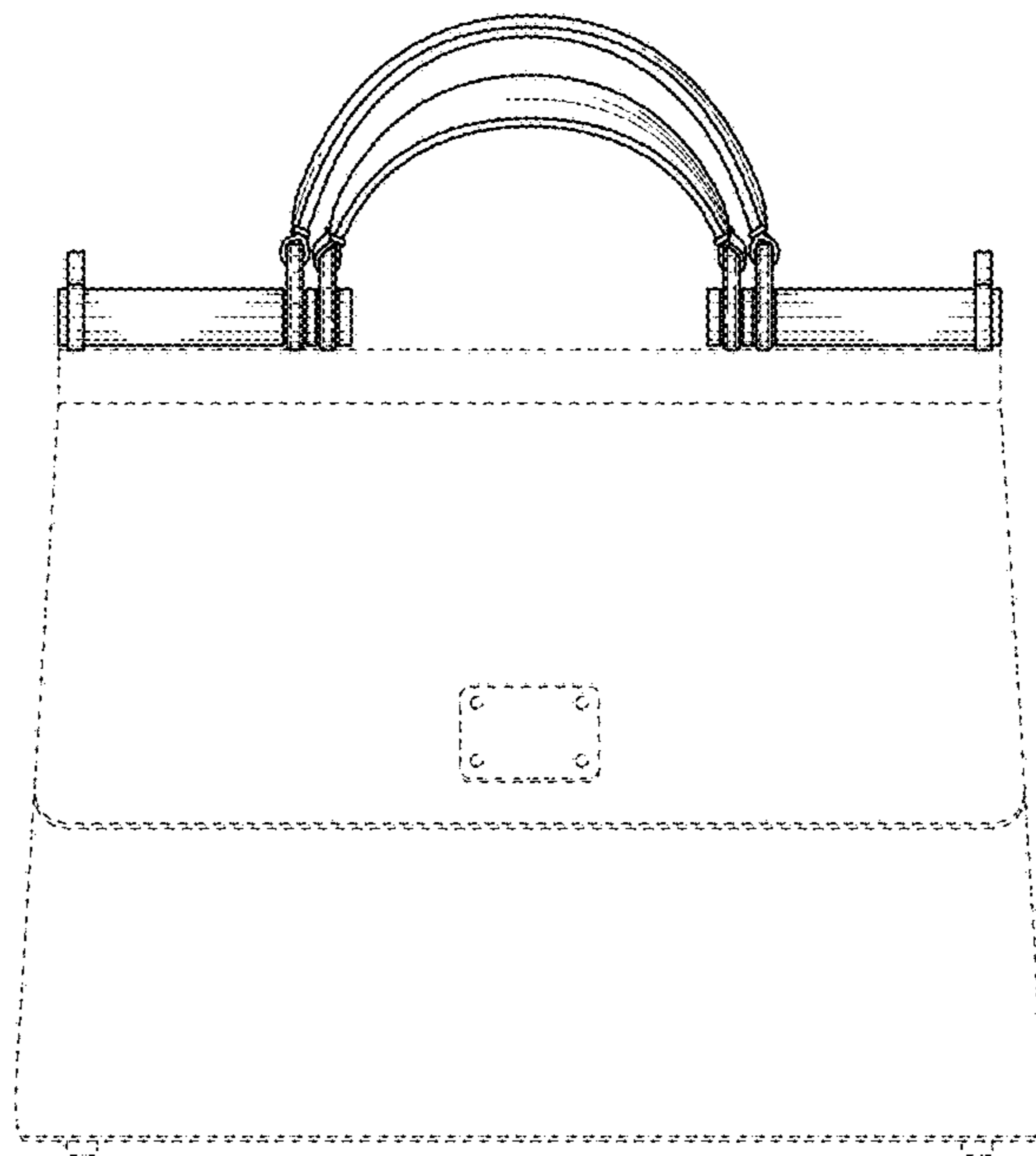

FIG. 2

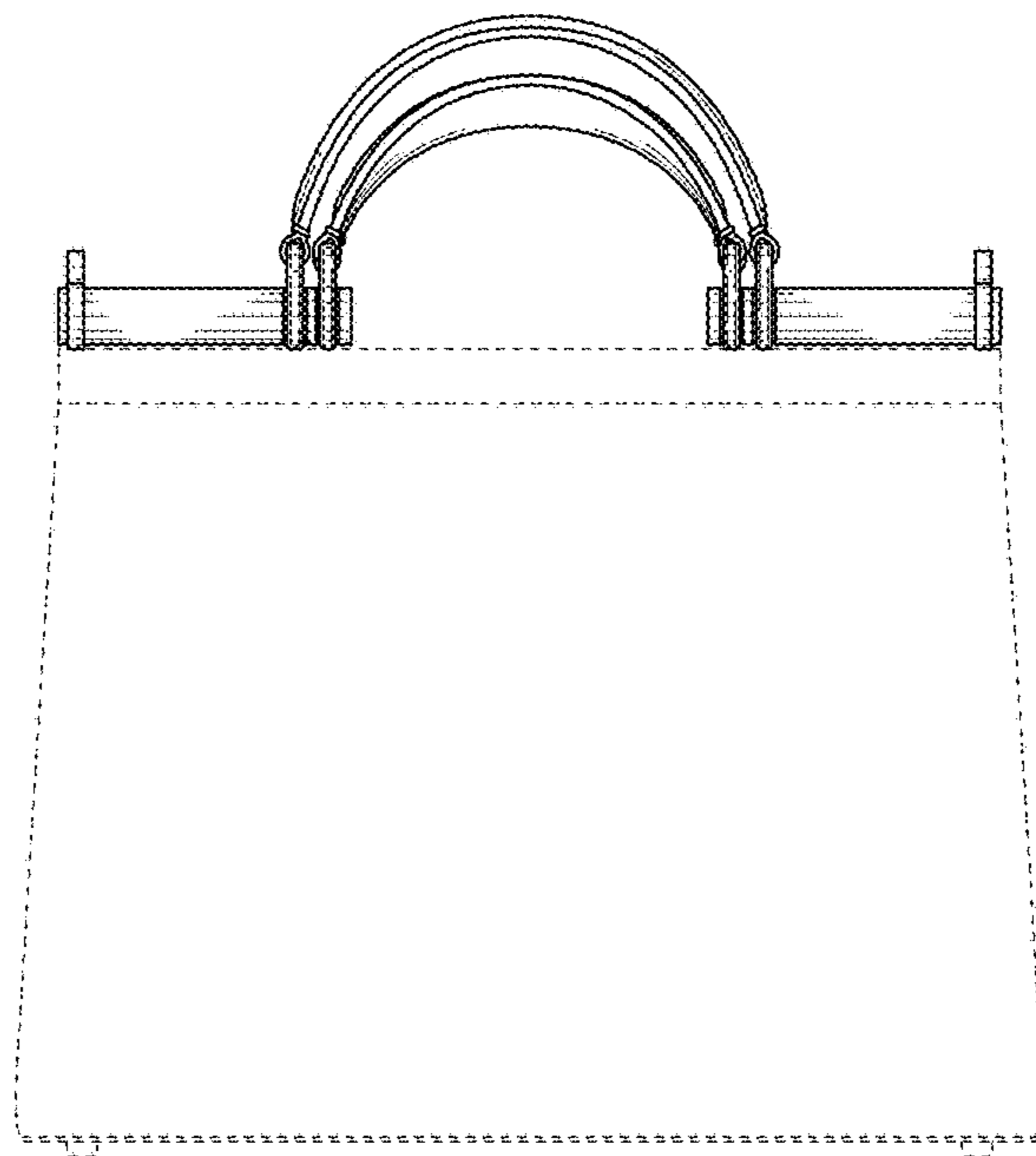

FIG. 3

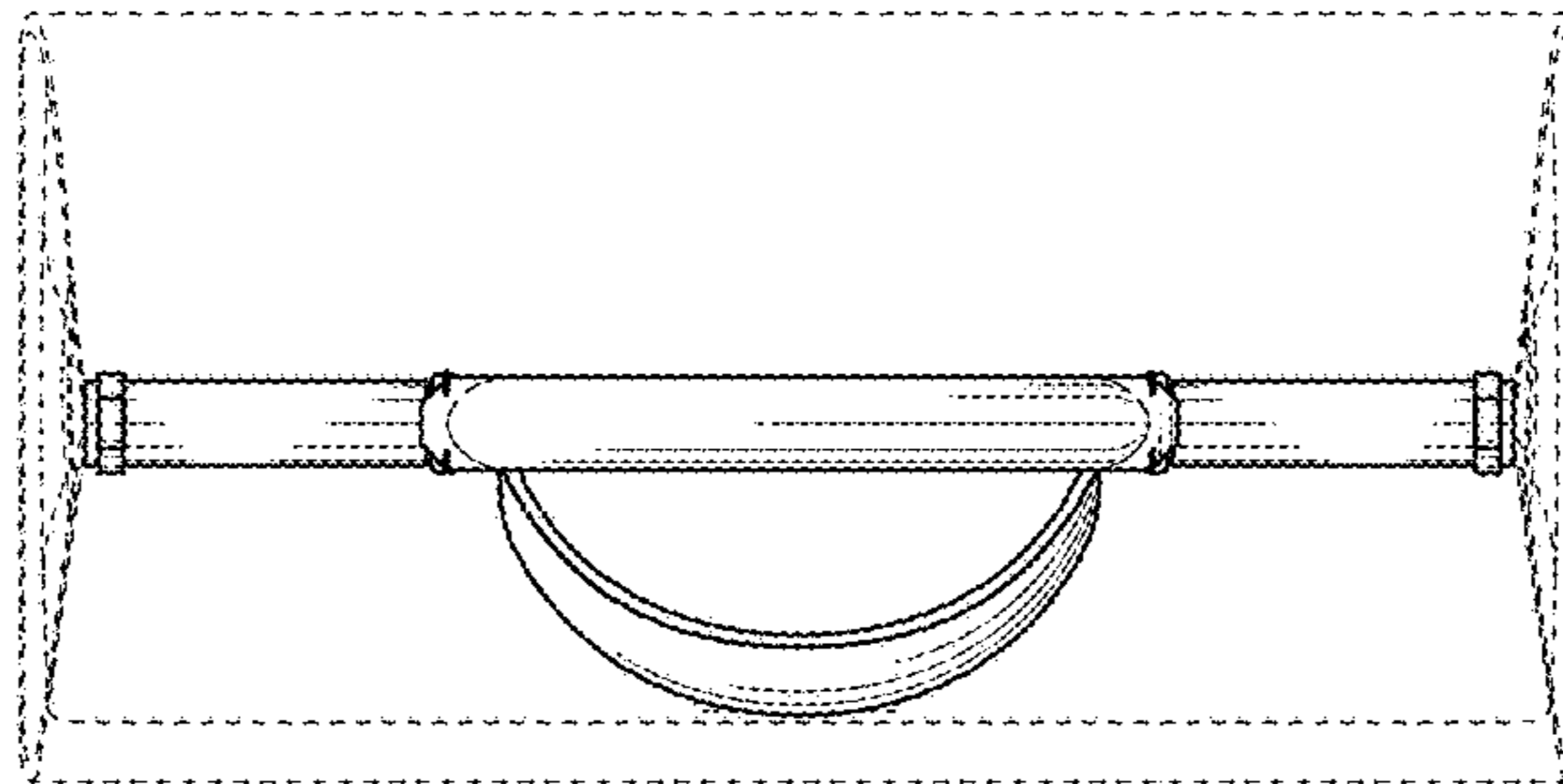

FIG. 4

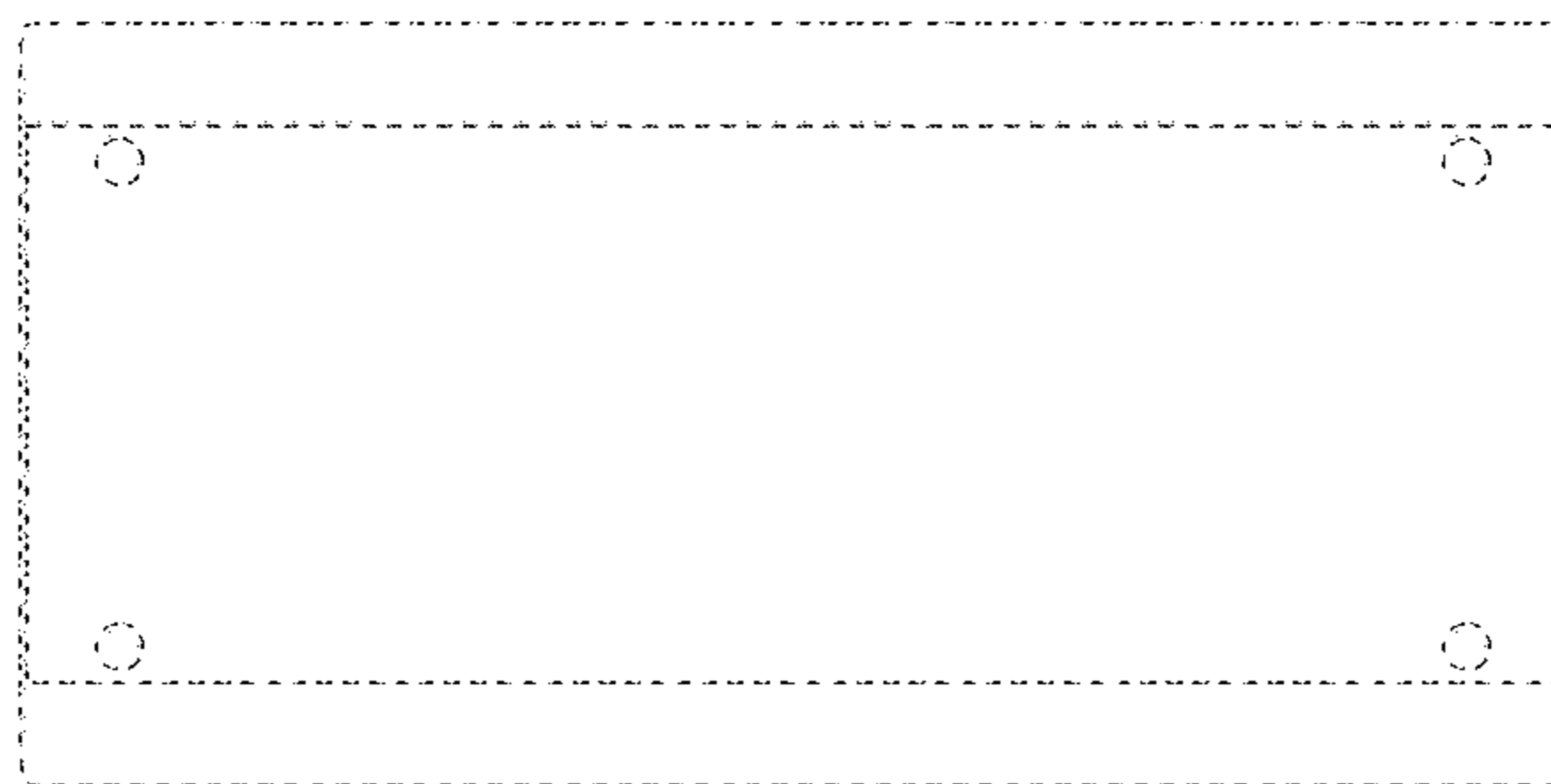

FIG. 5

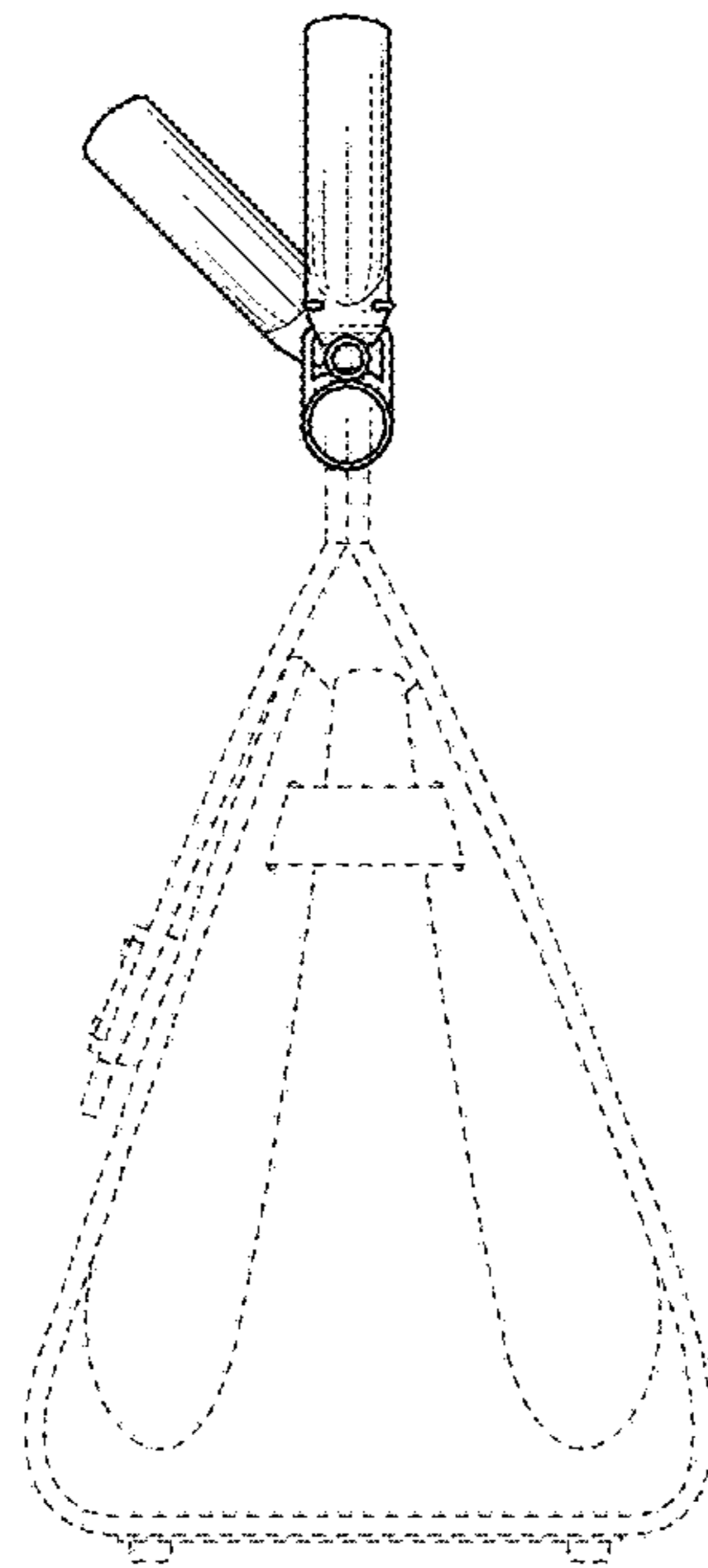

FIG. 6



FIG. 7

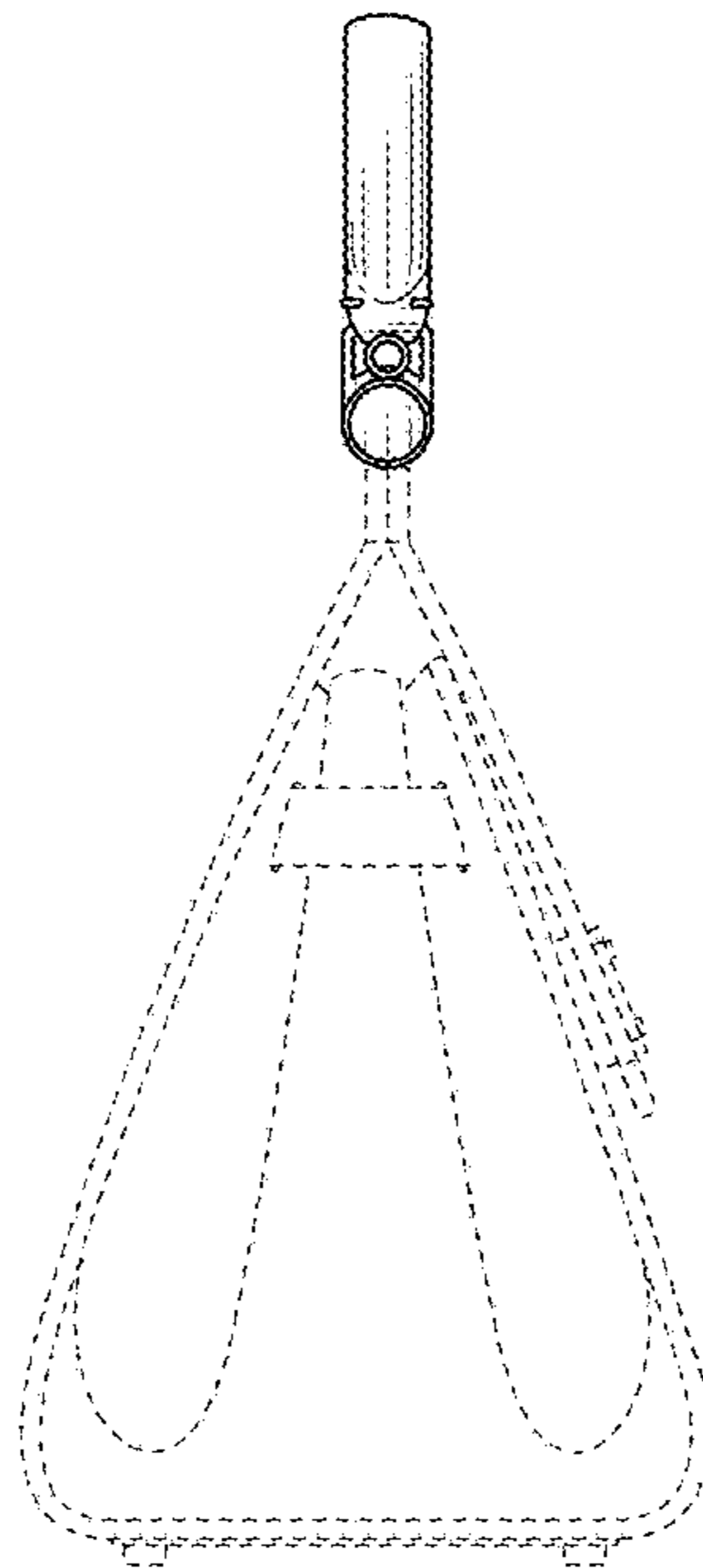

FIG. 8

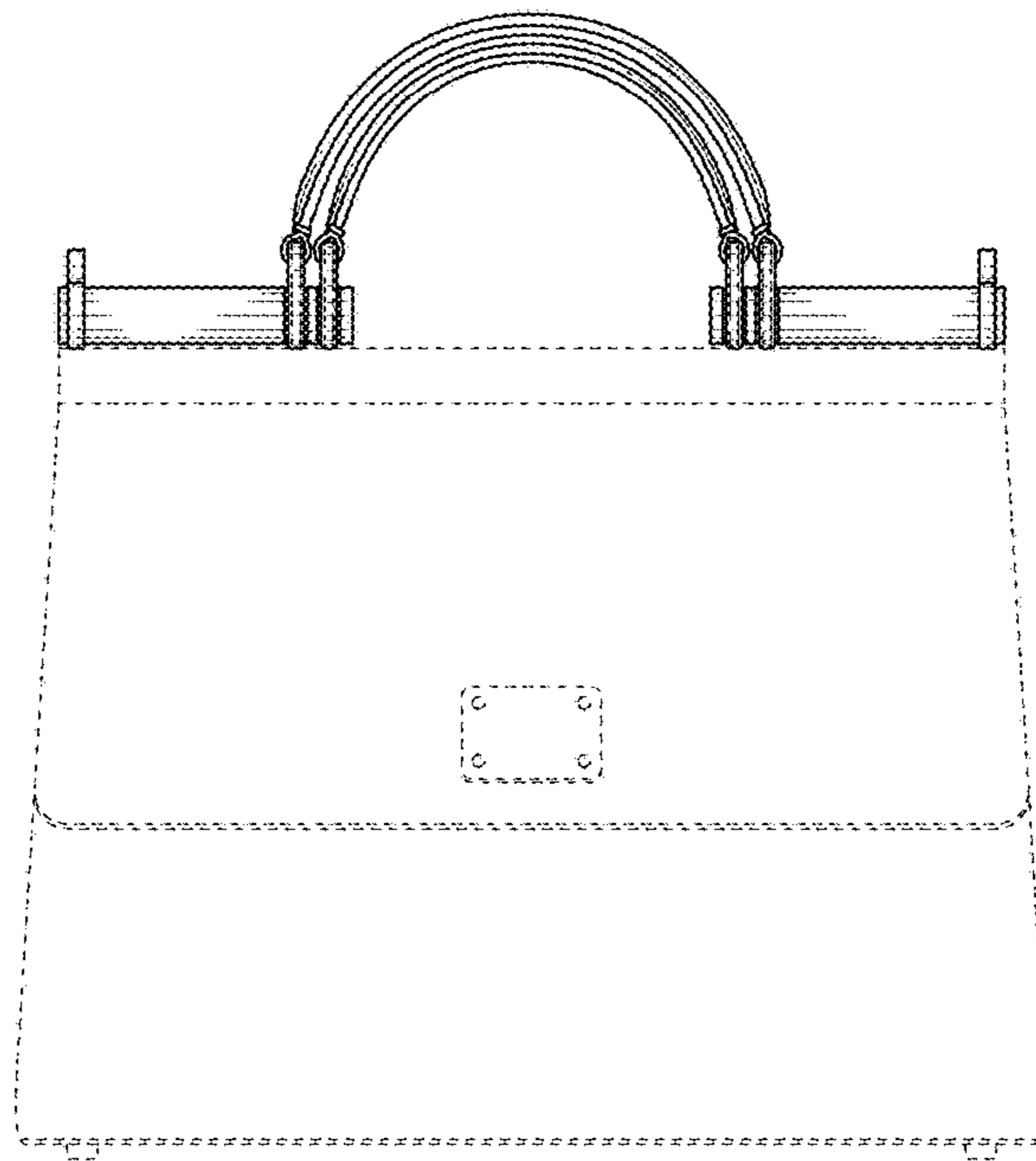

FIG. 9

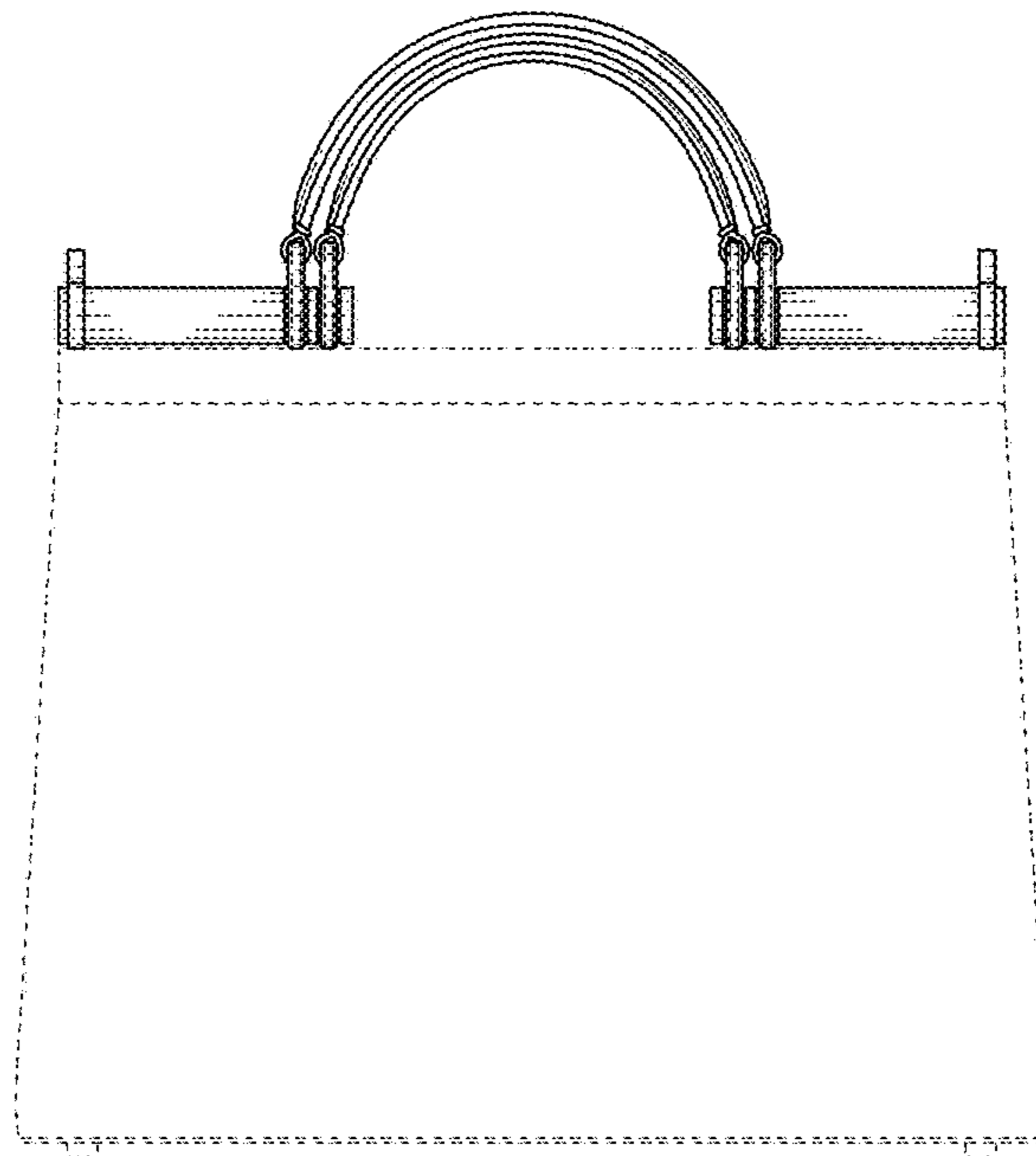

FIG. 10