



US00D862836S

(12) **United States Design Patent**
Bauer et al.

(10) **Patent No.:** **US D862,836 S**
(45) **Date of Patent:** **** Oct. 15, 2019**

(54) **TEXTURED CONFECTIONARY**

DESCRIPTION

- (71) Applicant: **WM. WRIGLEY JR. COMPANY**,
Chicago, IL (US)
- (72) Inventors: **Kari Bauer**, Chicago, IL (US); **Dennis W. Rybolt**, Beecher, IL (US)
- (73) Assignee: **WM. WRIGLEY JR. COMPANY**,
Chicago, IL (US)
- (**) Term: **15 Years**
- (21) Appl. No.: **29/548,921**
- (22) Filed: **Dec. 17, 2015**
- (51) **LOC (12) Cl.** **01-01**
- (52) **U.S. Cl.**
USPC **D1/127**
- (58) **Field of Classification Search**
USPC D1/100–130, 199; 426/5, 76, 87, 92, 94,
426/95, 99, 101, 103, 108, 138–139, 143,
(Continued)

(56) **References Cited**

U.S. PATENT DOCUMENTS

- D22,882 S * 11/1893 Roes D1/129
- 787,887 A * 4/1905 Baker A23G 3/54
426/103

(Continued)

OTHER PUBLICATIONS

“Starburst Minis (Original).” Candyblog. Jun. 21, 2013. Web. May 28, 2019. <http://www.candyblog.net/blog/item/starburst_minis>.*

Primary Examiner — Katie Jane Stofko

(57) **CLAIM**

We claim the ornamental design for a textured confectionary, as substantially shown and described.

FIG. 1 is a front elevation view of a first embodiment of a textured confectionary in accordance with the present design, the rear elevation view being identical thereto;
 FIG. 2 is a left side elevation view thereof, the right side elevation view, top plan view and bottom plan view being identical thereto;
 FIG. 3 is a perspective view thereof;
 FIG. 4 is a front elevational view of a second embodiment of a textured confectionary, the rear elevation view being identical thereto;
 FIG. 5 is a left side elevation view thereof, the right side elevation view being identical thereto;
 FIG. 6 is a top plan view thereof, the bottom plan view being identical thereto;
 FIG. 7 is a perspective view thereof;
 FIG. 8 is a front elevation view of a third embodiment of a textured confectionary, the rear elevation view being identical thereto;
 FIG. 9 is a left side elevation view thereof, the right side elevation being identical thereto;
 FIG. 10 is a top plan view thereof, the bottom plan view being identical thereto;
 FIG. 11 is a perspective view thereof;
 FIG. 12 is a front elevation view of a fourth embodiment of a textured confectionary, the rear elevation view being identical thereto;
 FIG. 13 is a left side elevation view thereof, the right side elevation view being identical thereto;
 FIG. 14 is a top view thereof, the bottom plan view being identical thereto;
 FIG. 15 is a perspective view thereof;
 FIG. 16 is a front elevation view of a fifth embodiment of a textured confectionary, the rear side being identical thereto;
 FIG. 17 is a left side elevation view thereof, the right side elevational view being identical thereto;
 FIG. 18 is a top plan view thereof, the bottom plan view being identical thereto; and,
 FIG. 19 is a perspective view thereof.
 The shading in the Figures indicates that the surfaces have a glossy surface texture.

1 Claim, 5 Drawing Sheets

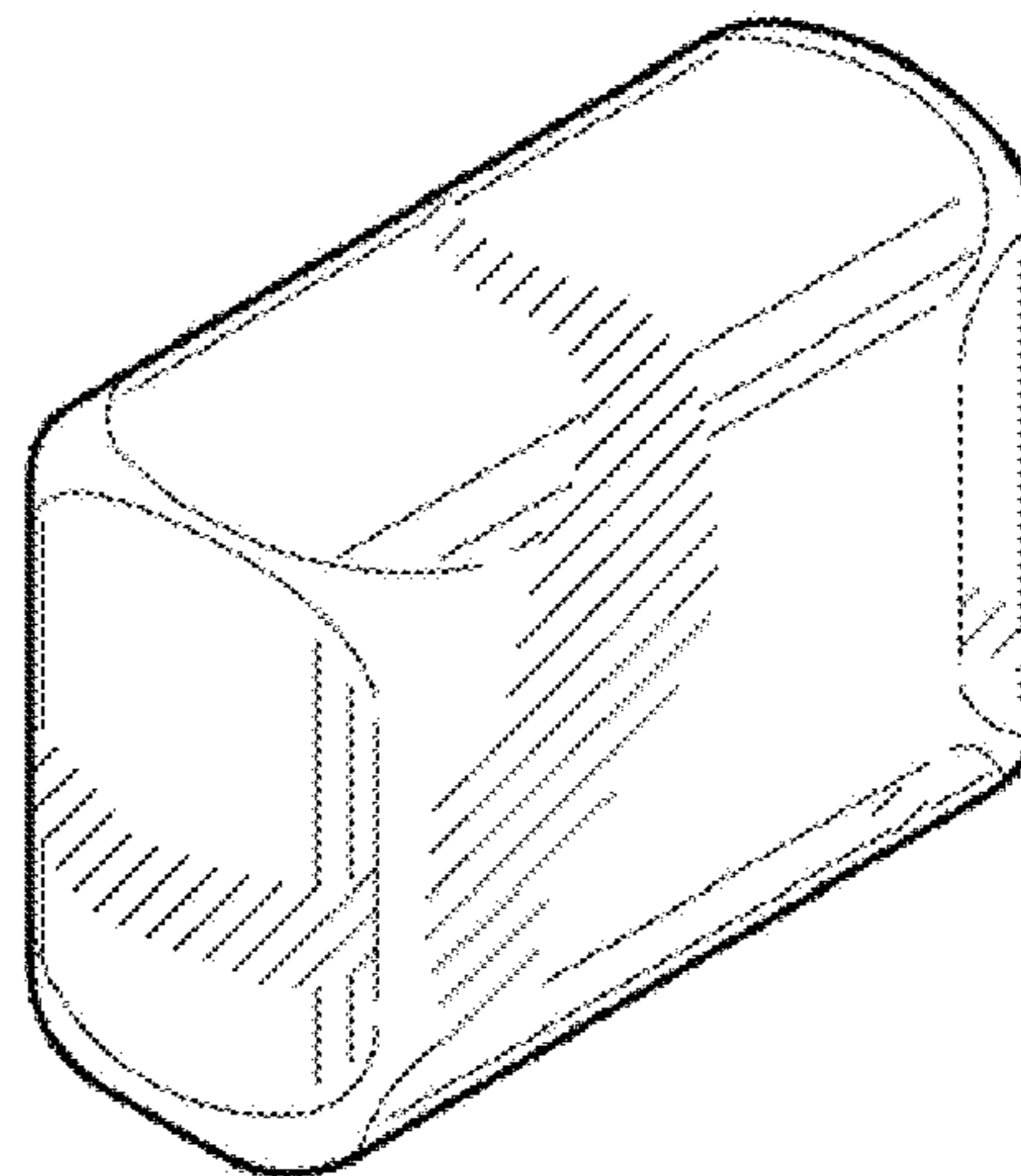
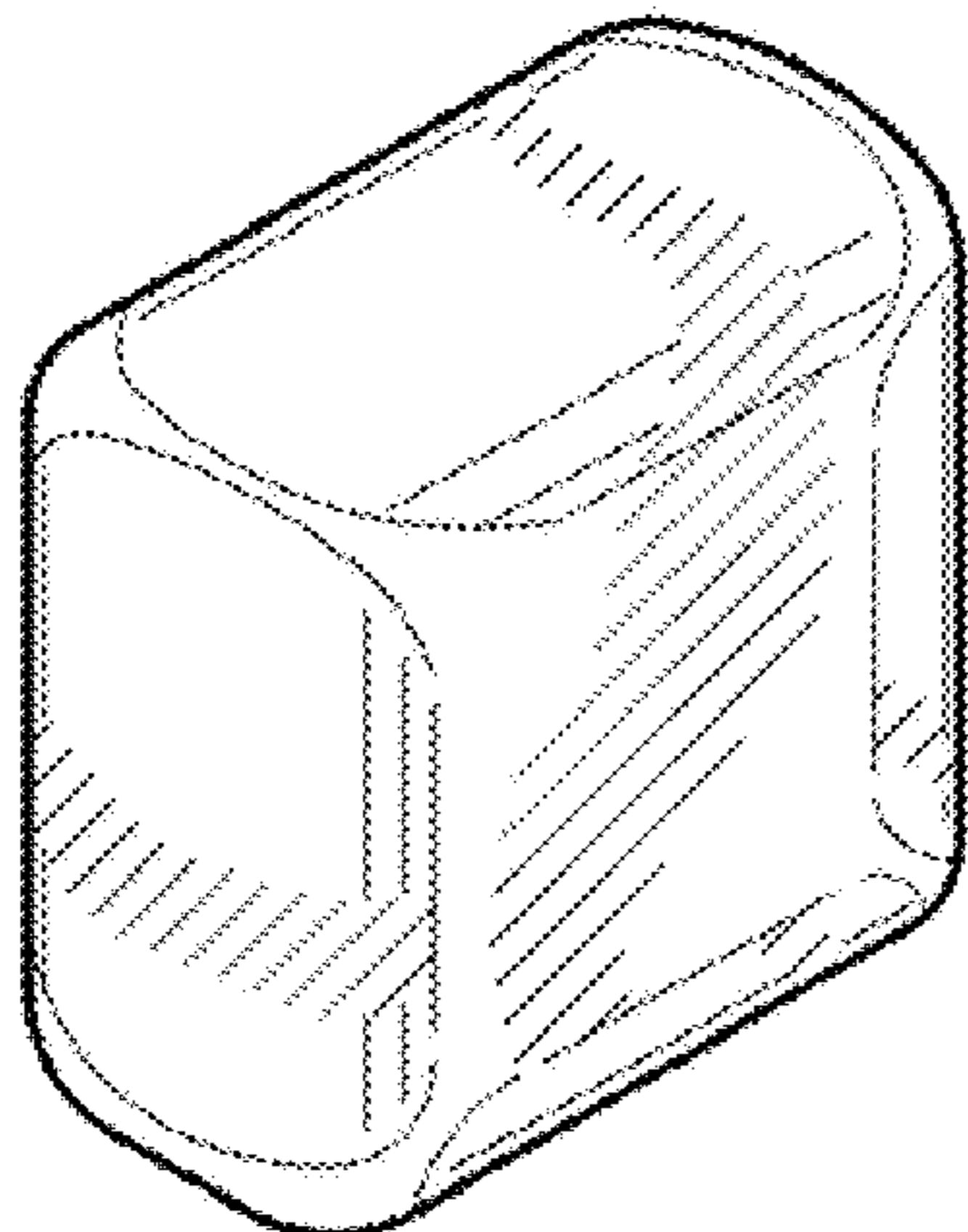

(58) **Field of Classification Search**

USPC 426/144, 279, 282, 283, 391, 514, 549,
 426/660, 72, 582, 73, 93, 104; D13/100;
 D24/101-104; D28/8.1; 424/438, 440,
 424/464, 470-472, 48, 401, 469;
 425/195; 34/296; D6/601; D10/108;
 D8/8.1, 8.2; D21/373, 499; D27/100
 CPC .. A61K 9/2072; A61K 9/0004; A61K 9/2095;
 A61K 9/209; A23G 4/02; A23G 4/06;
 A23G 4/08; A23G 4/10; A23G 4/20;
 A23G 4/00; A23G 3/38; A23G 3/42;
 A23G 3/54; A23G 3/50; A23G 9/48;
 A23K 1/164; A23V 2002/00

See application file for complete search history.

(56) **References Cited**

U.S. PATENT DOCUMENTS

1,901,394 A * 3/1933 Hassell A23G 9/245
 426/101
 2,987,445 A * 6/1961 Levesque A61K 9/2027
 106/122
 3,044,938 A * 7/1962 Halley A61K 9/2077
 424/470
 D266,030 S * 9/1982 Madonia 426/144
 4,362,751 A * 12/1982 Dogliotti A23G 3/2015
 426/94
 4,563,345 A * 1/1986 Arrick A23G 4/064
 424/48
 4,738,817 A * 4/1988 Wittwer A61J 3/07
 106/138.1
 D295,570 S * 5/1988 Muello D1/116
 5,603,219 A * 2/1997 Kolb F25D 3/08
 62/1

D425,286 S * 5/2000 Smoak D1/106
 6,060,078 A * 5/2000 Lee A61K 9/0056
 424/439
 D478,513 S * 8/2003 Canamasas Puigbo D9/529
 D485,421 S * 1/2004 Norton D1/127
 6,807,284 B2 * 10/2004 Nakamura H04R 1/021
 181/148
 D509,858 S * 9/2005 May D21/499
 D535,741 S * 1/2007 Stawski D24/101
 D583,526 S * 12/2008 Roach D1/128
 D608,840 S * 1/2010 Crutchfield D21/373
 7,968,130 B2 * 6/2011 Walter A21D 2/02
 426/496
 D658,823 S * 5/2012 Viola D30/160
 8,455,025 B2 * 6/2013 Stern A01K 15/026
 426/516
 8,557,323 B2 * 10/2013 Stawski A23G 3/34
 424/440
 D723,766 S * 3/2015 Kamakura D1/127
 D724,778 S * 3/2015 Hulan D24/100
 9,498,435 B2 * 11/2016 Allio A61K 36/9066
 D778,525 S * 2/2017 Gao D1/127
 D838,930 S * 1/2019 Kamper D1/128
 2003/0163149 A1 * 8/2003 Heisinger, Jr. A23G 1/30
 606/161
 2007/0160713 A1 * 7/2007 Walter A21D 2/02
 426/73
 2007/0231426 A1 * 10/2007 Acar A23G 4/20
 426/5
 2009/0202673 A1 * 8/2009 Phillips A23G 1/54
 426/5
 2011/0045726 A1 * 2/2011 Donovan C08L 33/26
 442/86
 2013/0071454 A1 * 3/2013 Stawski A23G 3/34
 424/401

* cited by examiner

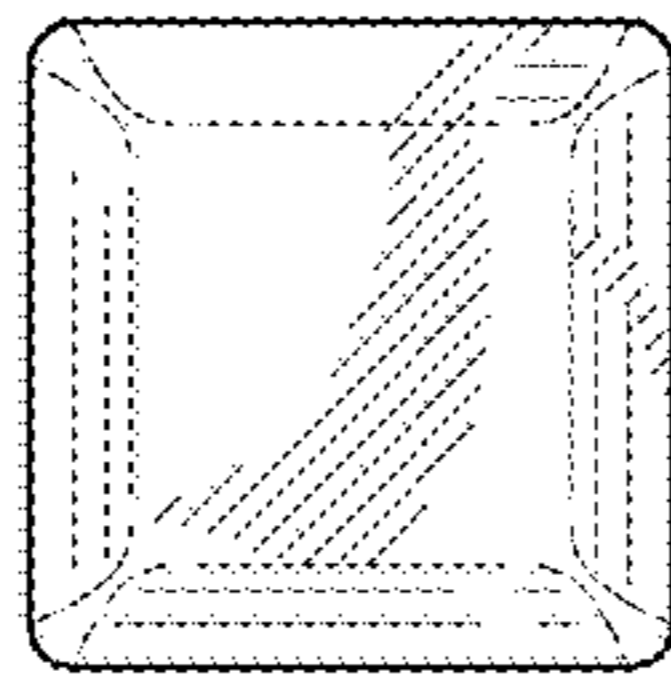

FIG. 1



FIG. 2

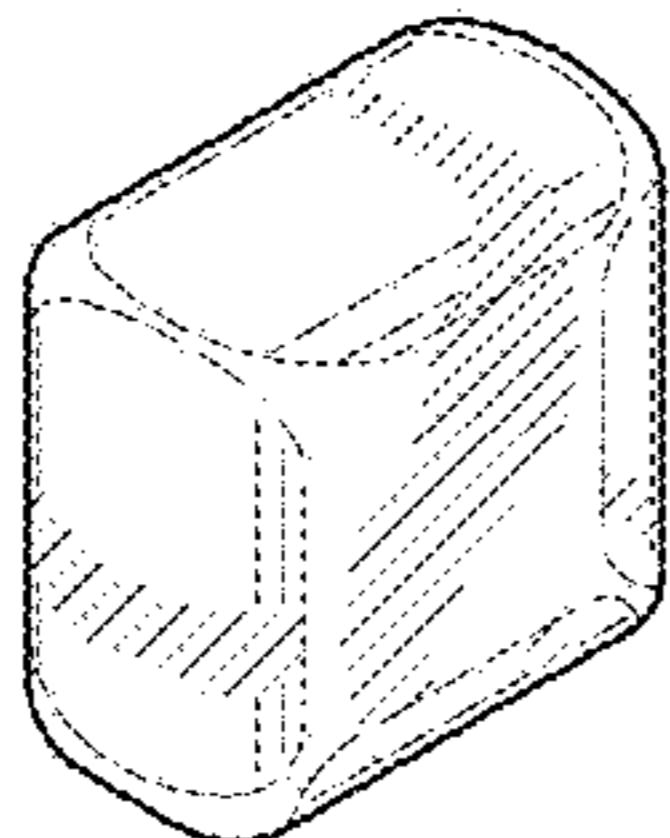

FIG. 3

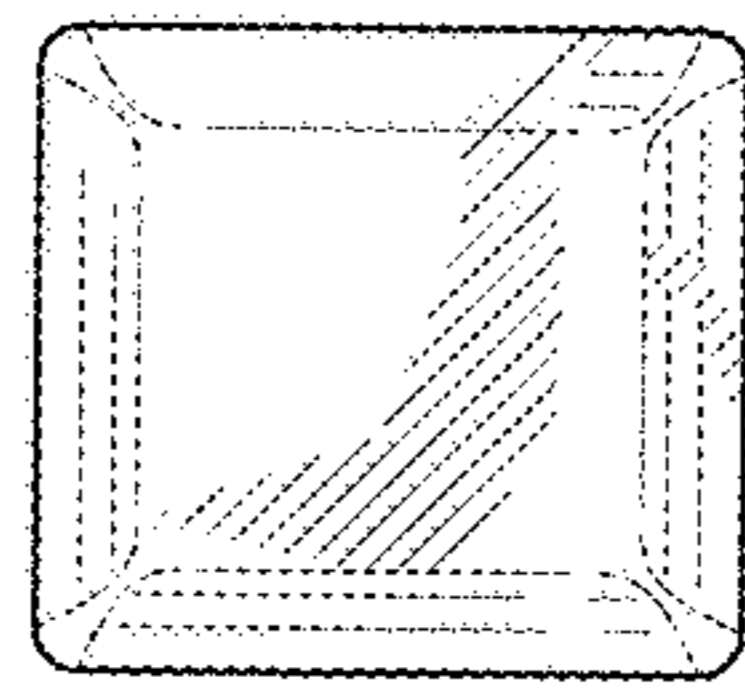

FIG. 4



FIG. 5

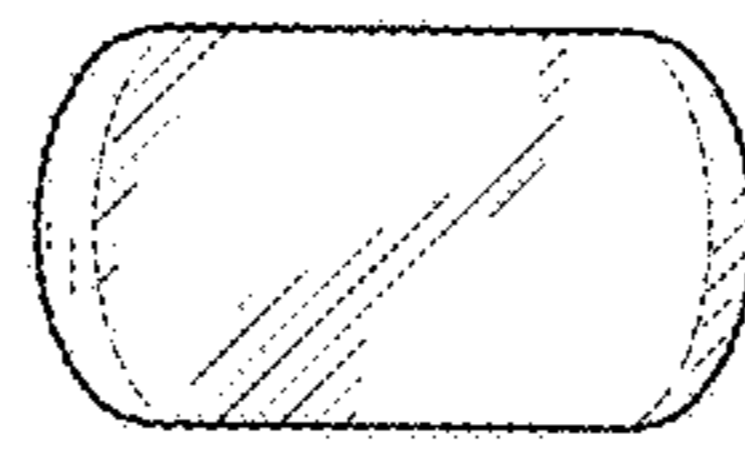

FIG. 6

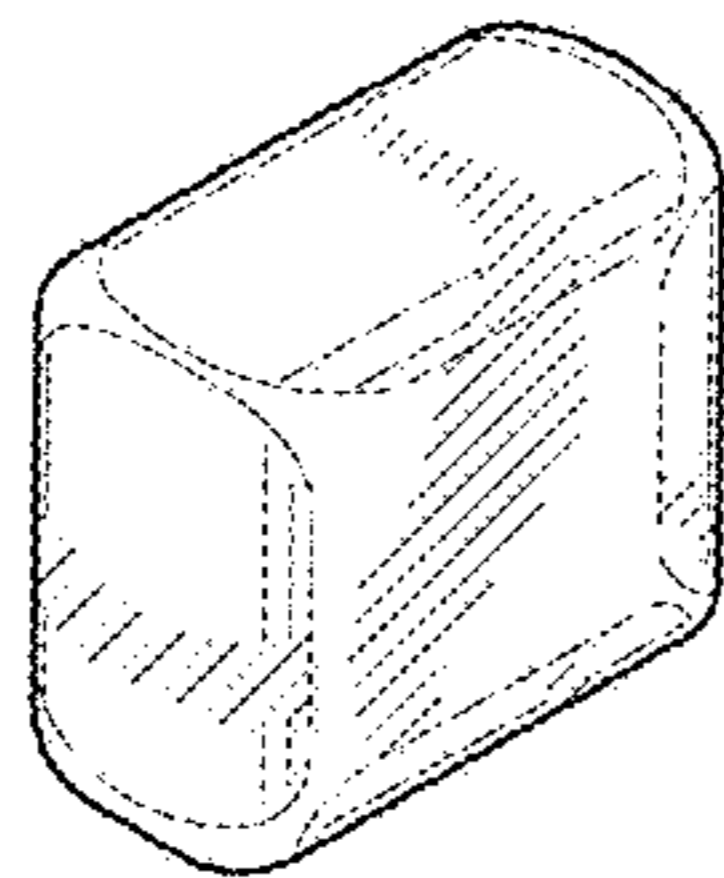

FIG. 7

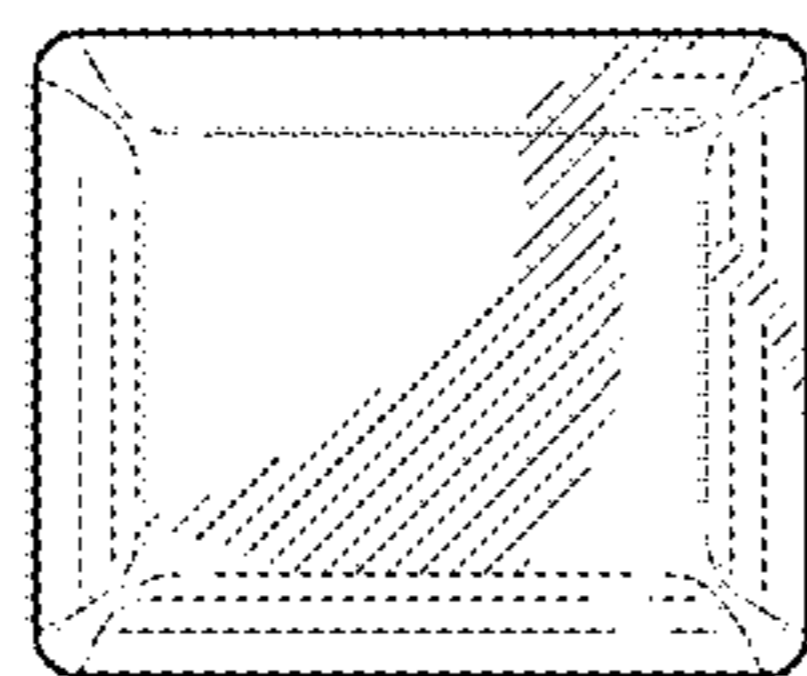

FIG. 8



FIG. 9

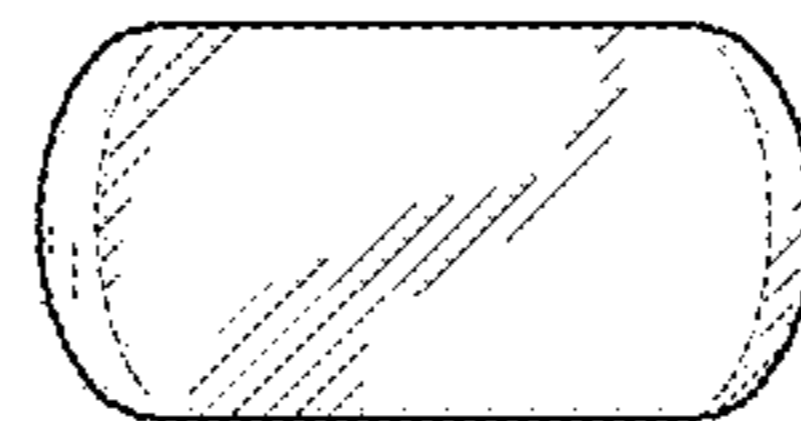

FIG. 10

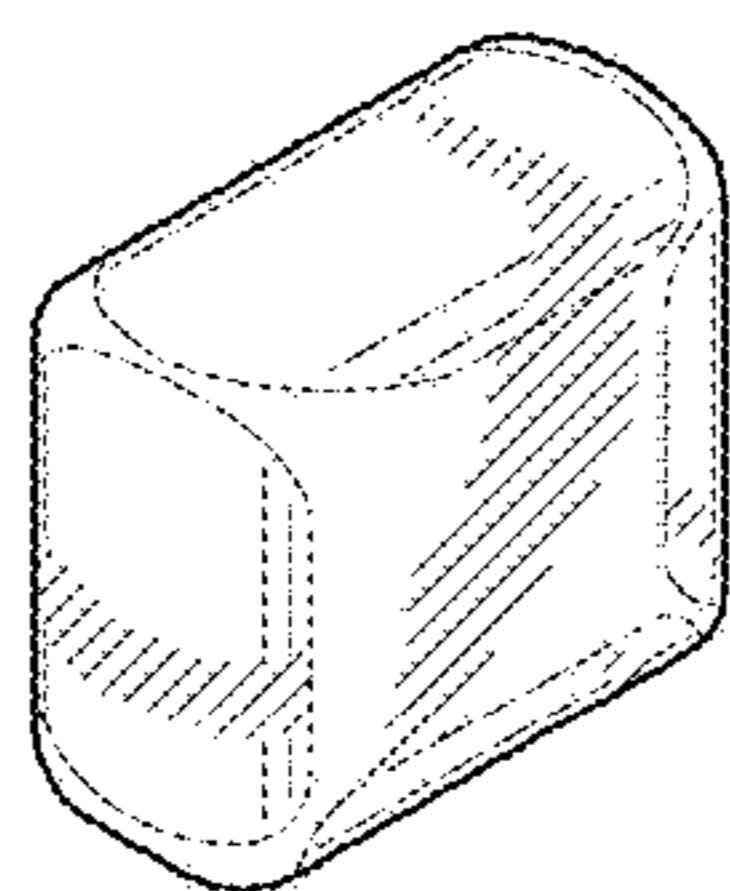

FIG. 11

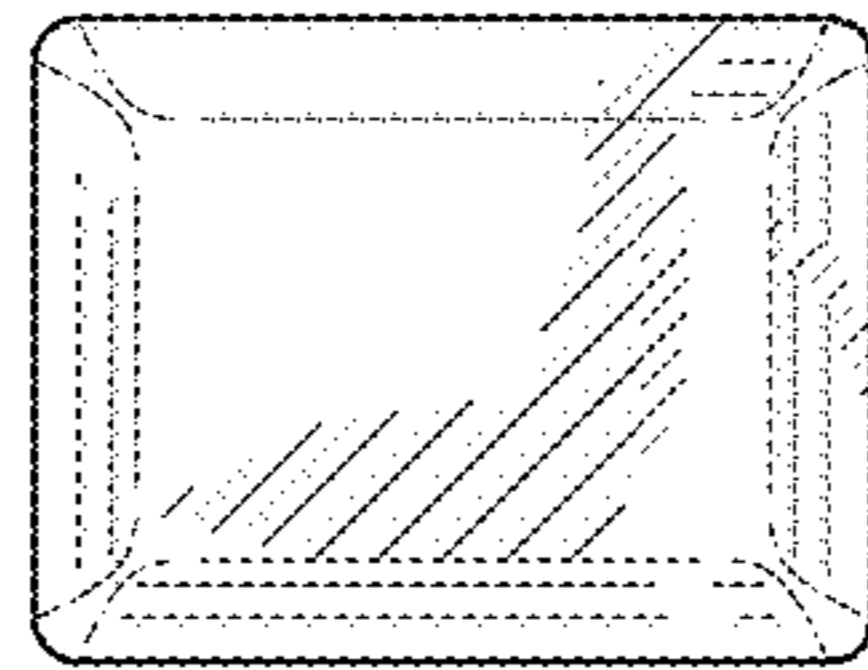

FIG. 12



FIG. 13

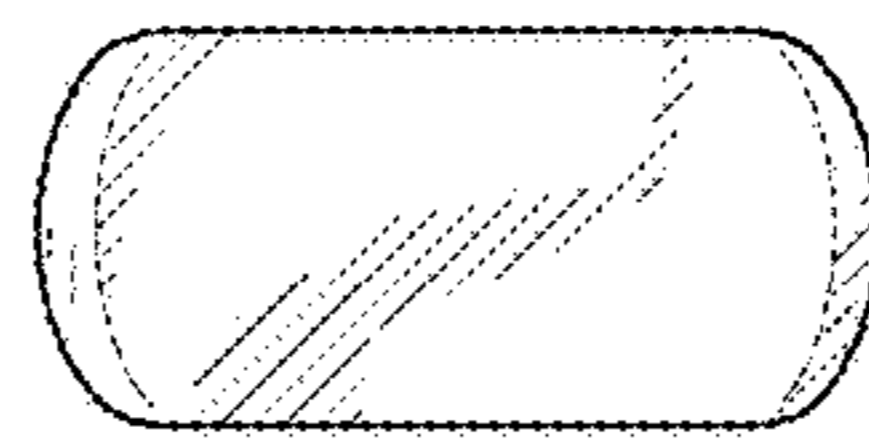

FIG. 14

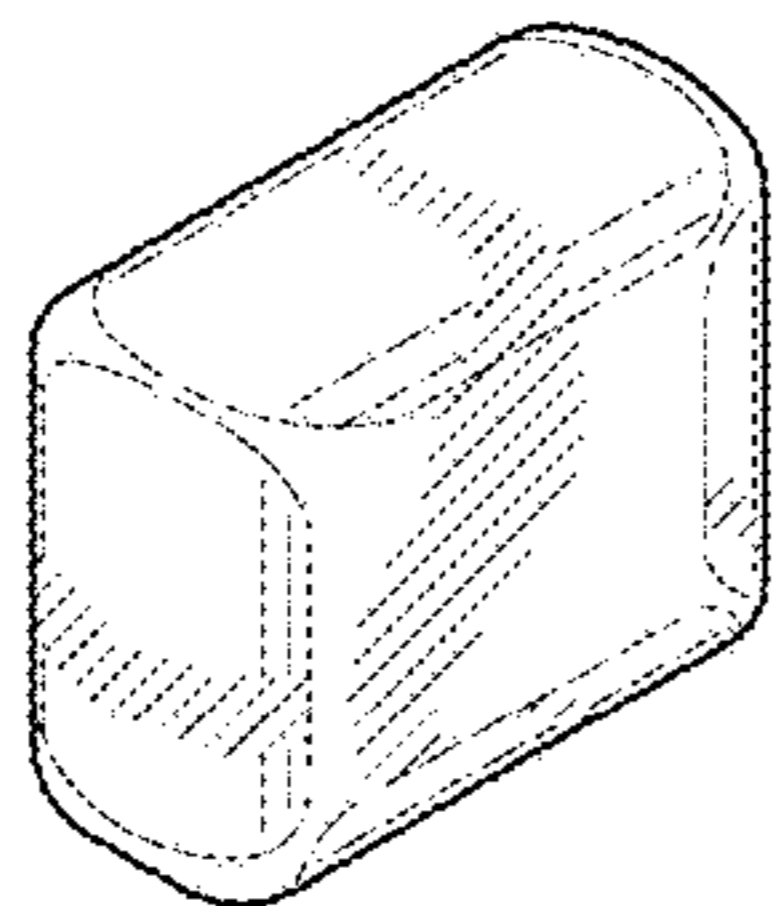

FIG. 15

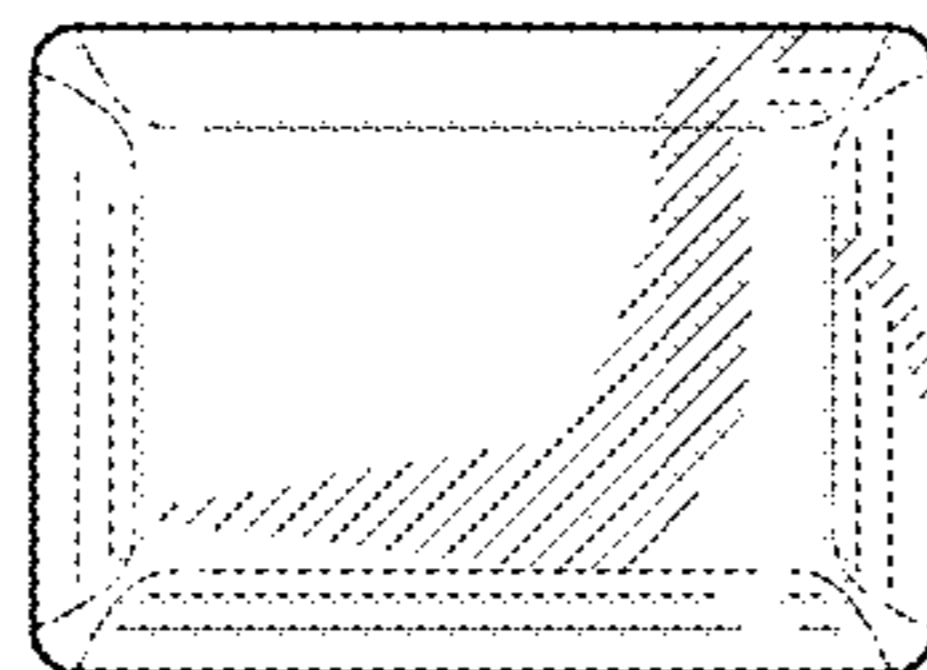

FIG. 16



FIG. 17

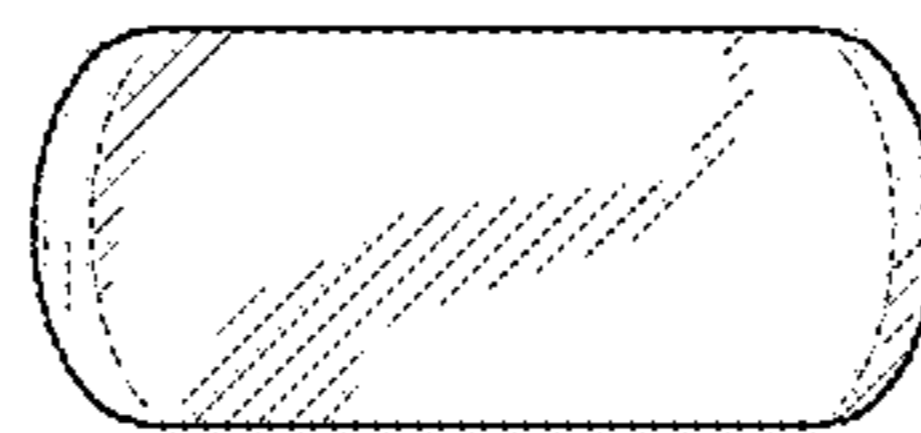

FIG. 18

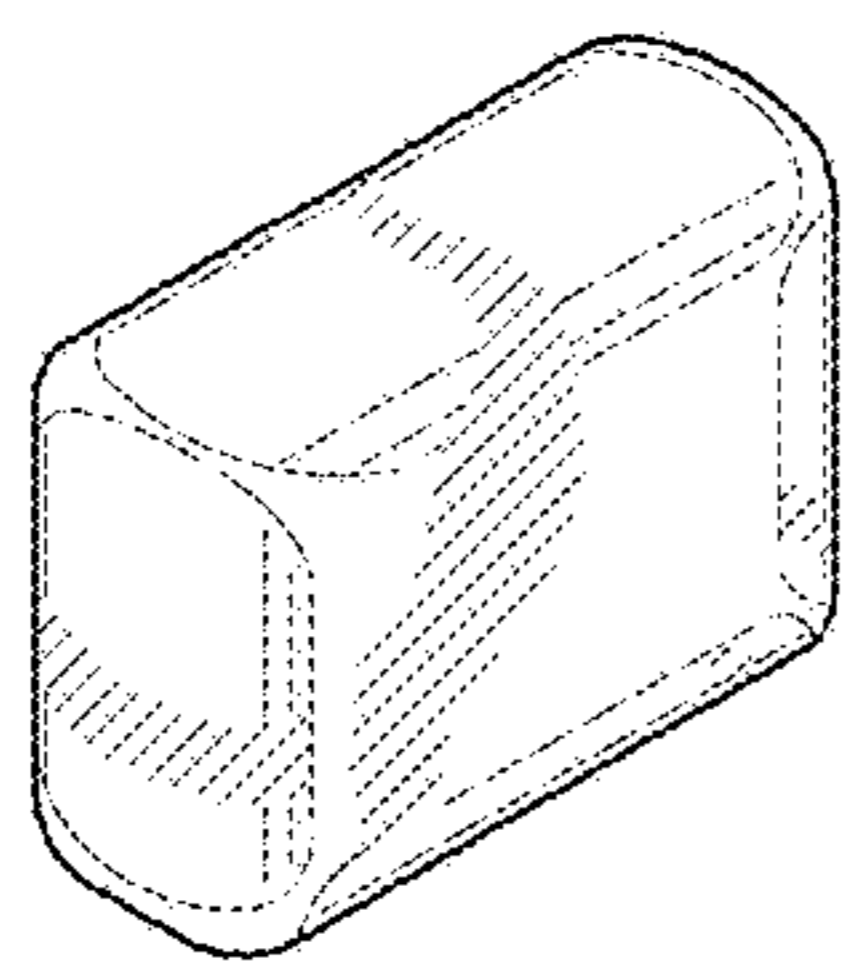

FIG. 19