



US00D862770S

(12) **United States Design Patent**  
**Coombes et al.**

(10) **Patent No.:** **US D862,770 S**

(45) **Date of Patent:** **\*\* Oct. 8, 2019**

(54) **LAMP**

(71) Applicant: **GIOPATO & COOMBES S.R.L.**,  
Treviso (IT)

(72) Inventors: **Christopher Coombes**, Treviso (IT);  
**Cristiana Giopato**, Treviso (IT)

(73) Assignee: **GIOPATO & COOMBES S.R.L.**,  
Treviso (IT)

(\*\*) Term: **15 Years**

(21) Appl. No.: **29/642,408**

(22) Filed: **Mar. 29, 2018**

(51) **LOC (12) Cl.** ..... **26-03**

(52) **U.S. Cl.**  
USPC ..... **D26/85**

(58) **Field of Classification Search**  
USPC ..... D26/72, 80–92, 118, 143, 144  
CPC .... F21S 8/03; F21S 8/033; F21S 8/036; F21S  
8/037; F21S 8/038; F21S 8/04; F21S  
8/043; F21S 8/046; F21S 8/06; F21S  
8/061; F21S 8/063; F21S 8/065; F21S  
8/068

See application file for complete search history.

(56) **References Cited**

U.S. PATENT DOCUMENTS

D76,194 S *	8/1928	Knorr	.....	D26/84
D80,639 S *	3/1930	Rosenblatt	.....	D26/80
D226,532 S *	3/1973	Ishii	.....	D26/84
3,745,327 A *	7/1973	Lowery	.....	F21S 8/033 362/146
D228,146 S *	8/1973	Schwartz	.....	D26/82
D288,247 S *	2/1987	De Lucchi	.....	D26/85
D292,525 S *	10/1987	Van Deelen	.....	D26/85
D294,399 S *	2/1988	Platner	.....	D26/81
D298,059 S *	10/1988	Muller	.....	D26/86
D299,762 S *	2/1989	King	.....	D26/87
D309,955 S *	8/1990	Gismondi	.....	D26/87

D402,387 S *	12/1998	Stewart	.....	D26/81
D422,373 S *	4/2000	Tihany	.....	D26/85
D644,778 S *	9/2011	Lovegrove	.....	D26/83
D646,423 S *	10/2011	Chiu	.....	D26/85
D655,847 S *	3/2012	Sabernig	.....	D26/83
D655,850 S *	3/2012	Sabernig	.....	D26/85
D656,653 S *	3/2012	Sabernig	.....	D26/83
D666,764 S *	9/2012	Gilad	.....	D26/79
D671,255 S *	11/2012	Sonneman	.....	D26/85
D674,951 S *	1/2013	Sonneman	.....	D26/80
D674,953 S *	1/2013	Sonneman	.....	D26/86
D747,025 S *	1/2016	Skira	.....	D26/85
D747,531 S *	1/2016	Skira	.....	D26/85
D780,979 S *	3/2017	Urquiola	.....	D26/88
D791,385 S *	7/2017	Sonneman	.....	D26/84
D791,388 S *	7/2017	Sonneman	.....	D26/90
D792,633 S *	7/2017	Sonneman	.....	D26/84

(Continued)

OTHER PUBLICATIONS

Gioielli Collection found at giopatocoombes.com, visited Mar. 13, 2019. (Year: 2019).\*

(Continued)

*Primary Examiner* — Clare E Heflin

(74) *Attorney, Agent, or Firm* — Cantor Colburn LLP

(57) **CLAIM**

We claim, the ornamental design for a lamp, as shown and described.

**DESCRIPTION**

FIG. 1 is a perspective view of a lamp, showing my new design;  
FIG. 2 is a front elevation view thereof;  
FIG. 3 is a rear elevation view thereof;  
FIG. 4 is a left side elevation view thereof;  
FIG. 5 is a right side elevation view thereof;  
FIG. 6 is a top plan view thereof; and,  
FIG. 7 is a bottom plan view thereof.

**1 Claim, 6 Drawing Sheets**

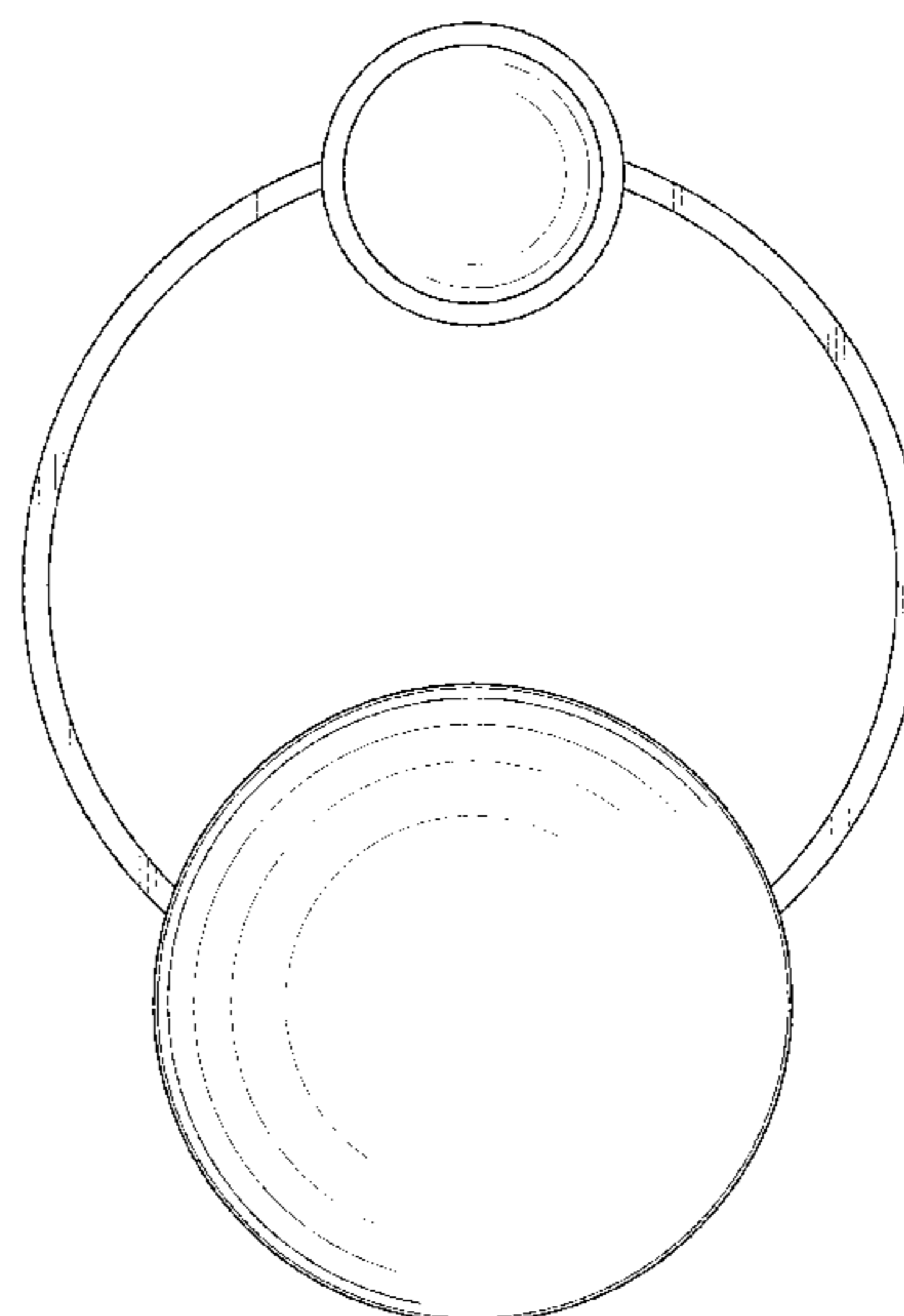
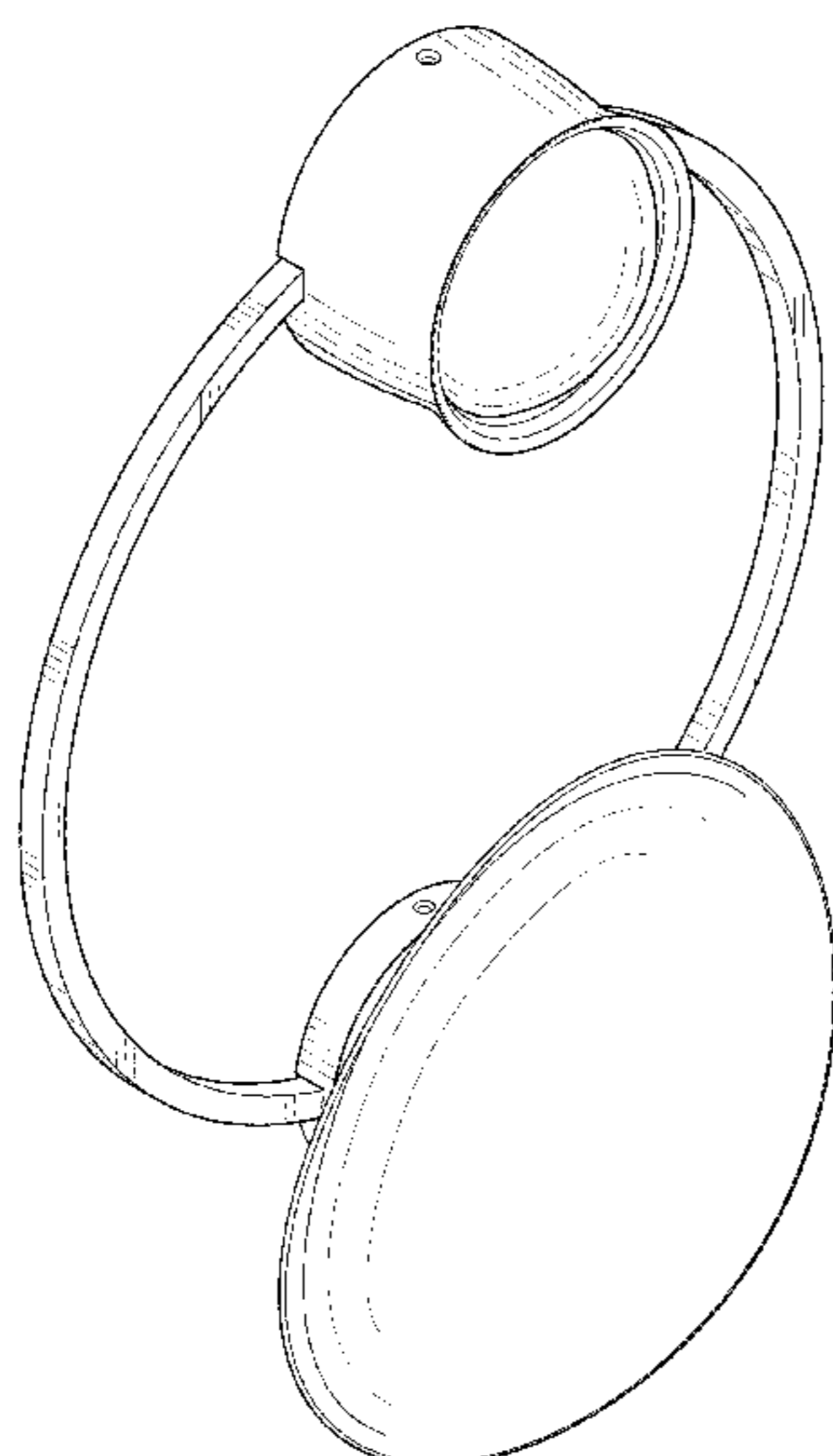

(56)

**References Cited**

U.S. PATENT DOCUMENTS

D809,695	S	*	2/2018	Verelst	.....	D26/72
D813,440	S	*	3/2018	Xia	.....	D26/89
D821,629	S	*	6/2018	Amato	.....	D26/87
D826,451	S	*	8/2018	Sonneman	.....	D26/80
D833,057	S	*	11/2018	Cho	.....	D26/87

OTHER PUBLICATIONS

AD Magazine post on Instagram by 'giopatocoombes', Apr. 13, 2017. (Year: 2017).\*

Raw Edge Alabaster sconce model No. 525244 from cb2.com, visited Mar. 13, 2019. (Year: 2019).\*

\* cited by examiner

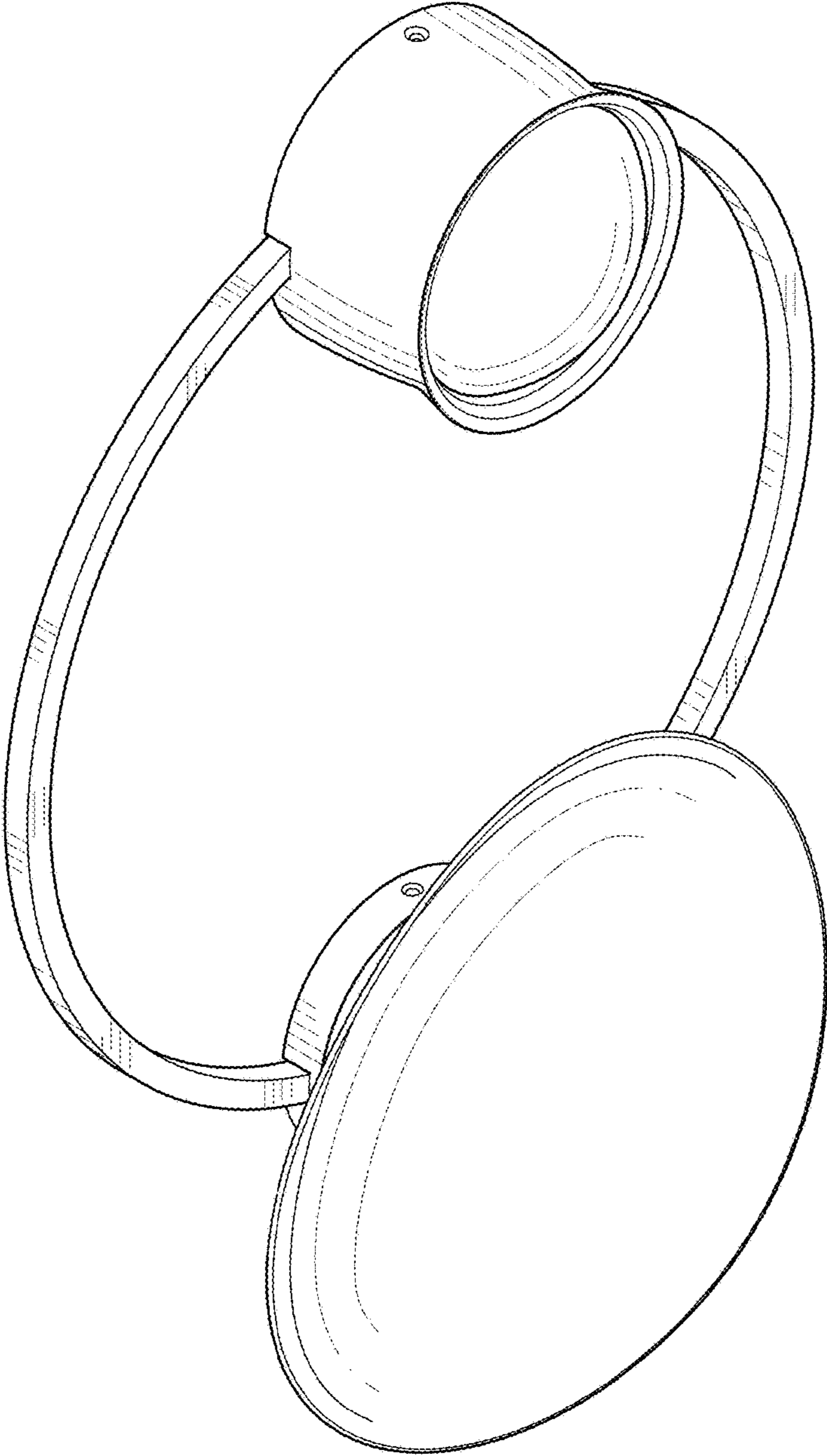

*Fig. 1*

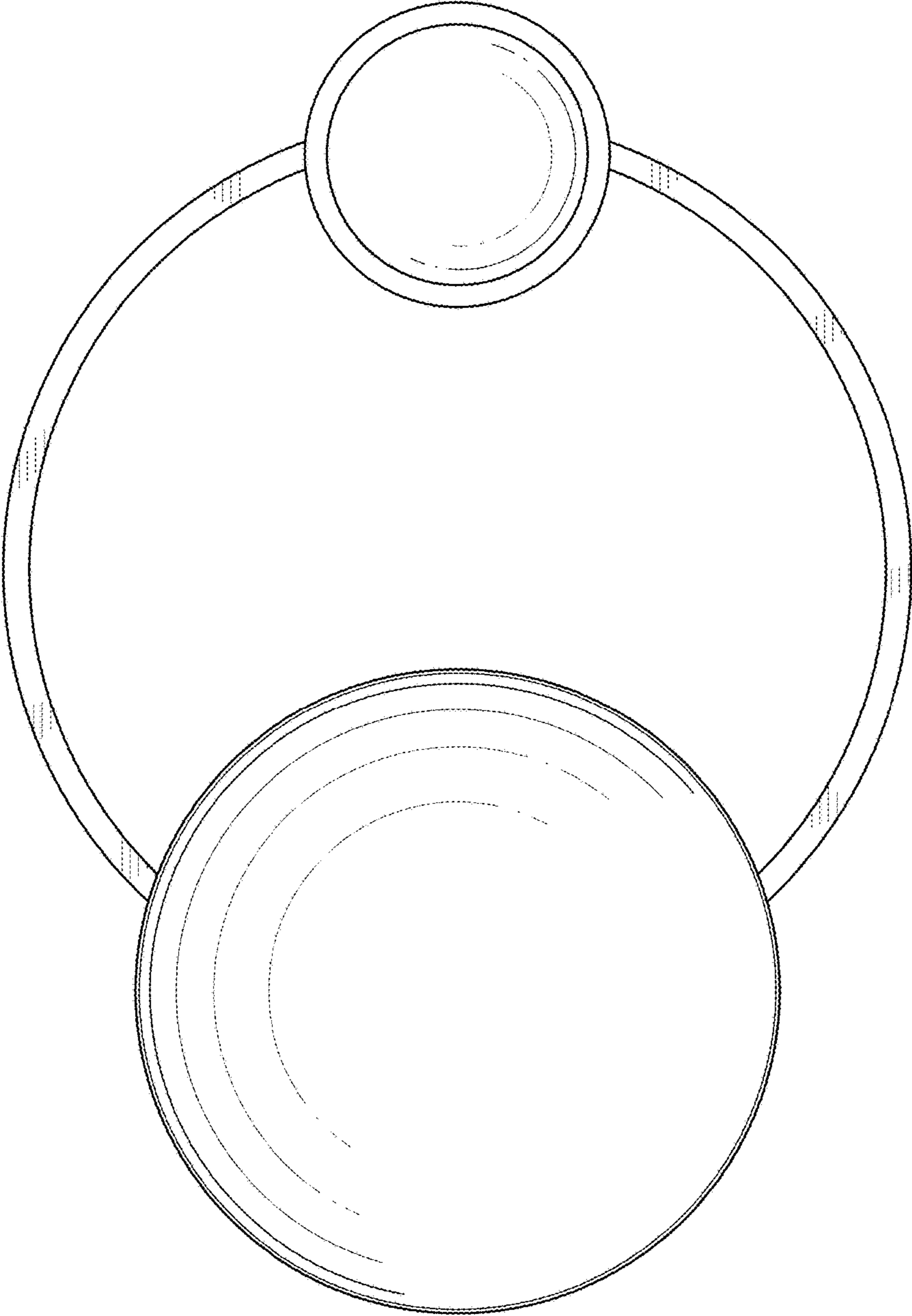

*Fig. 2*

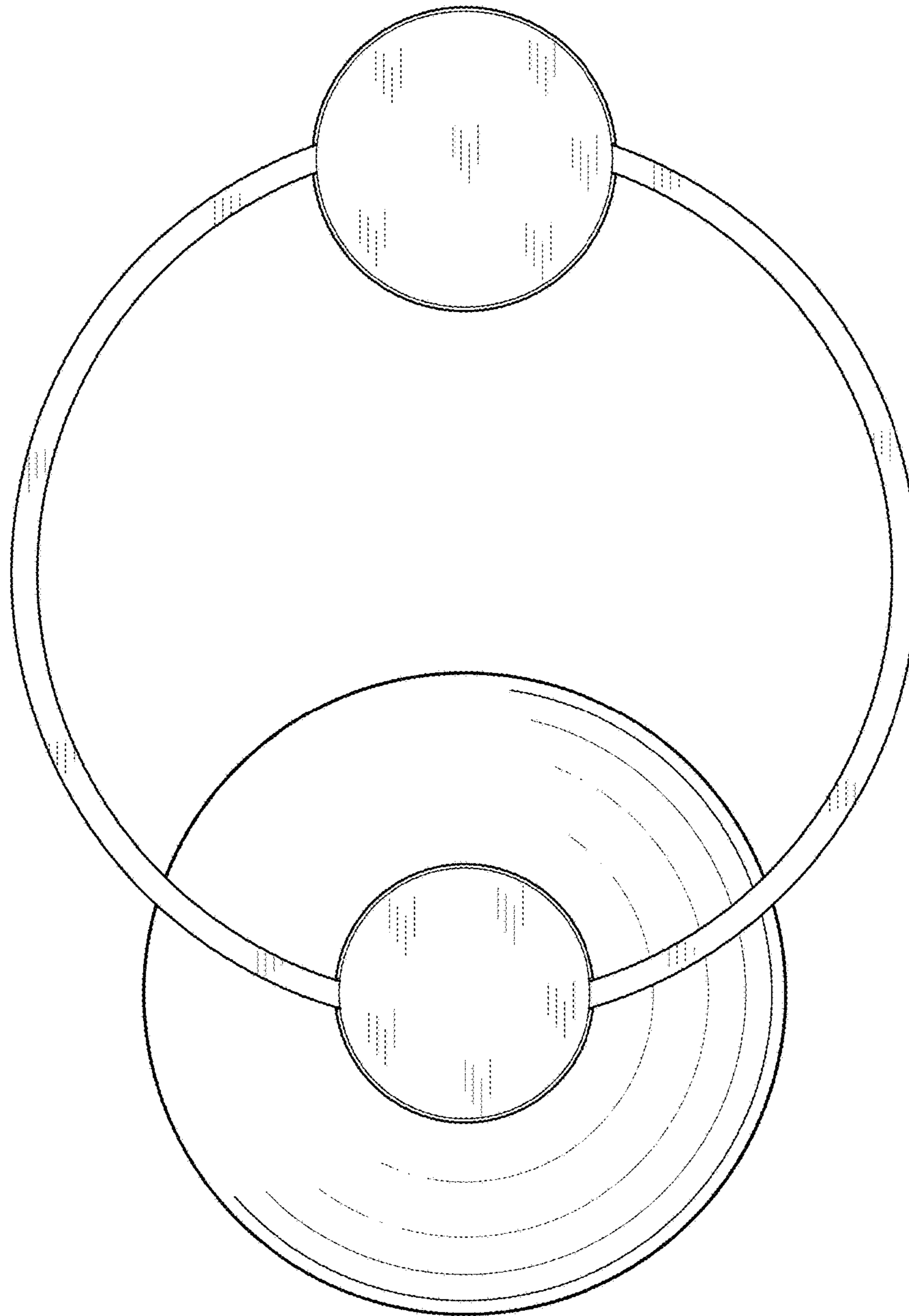

*Fig. 3*

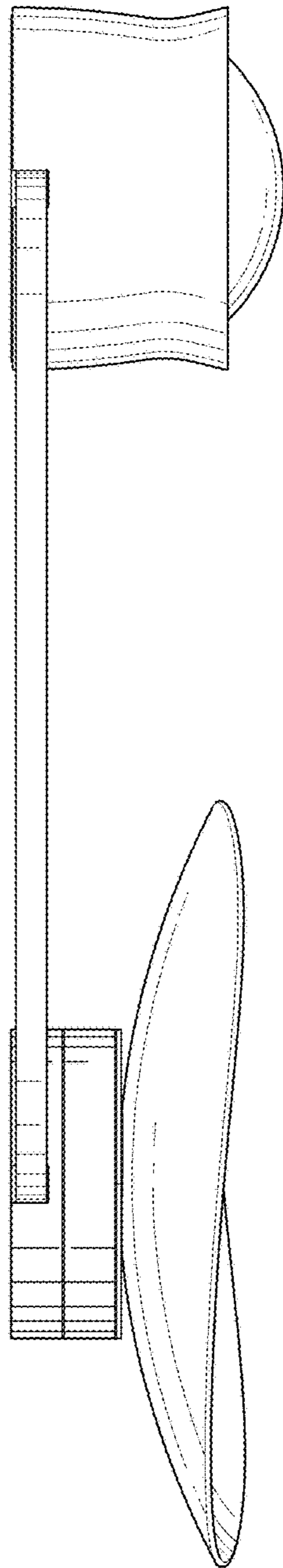

*Fig. 4*

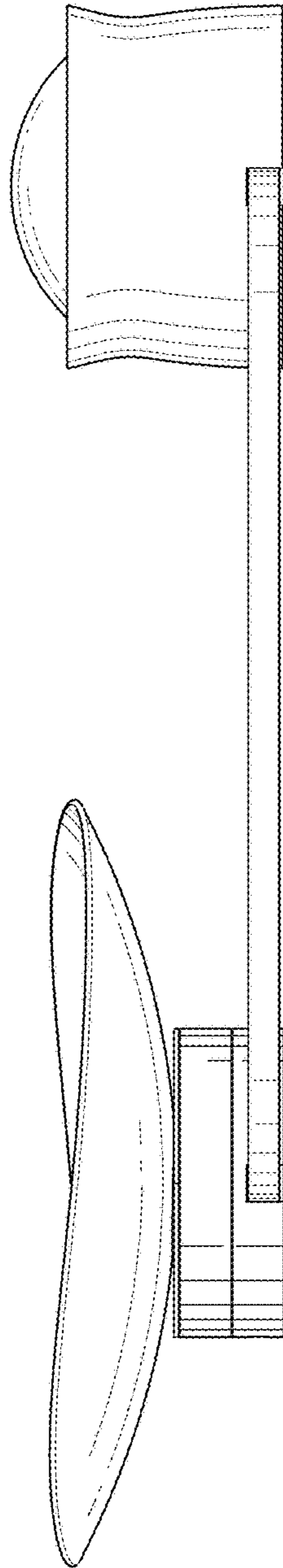

*Fig. 5*

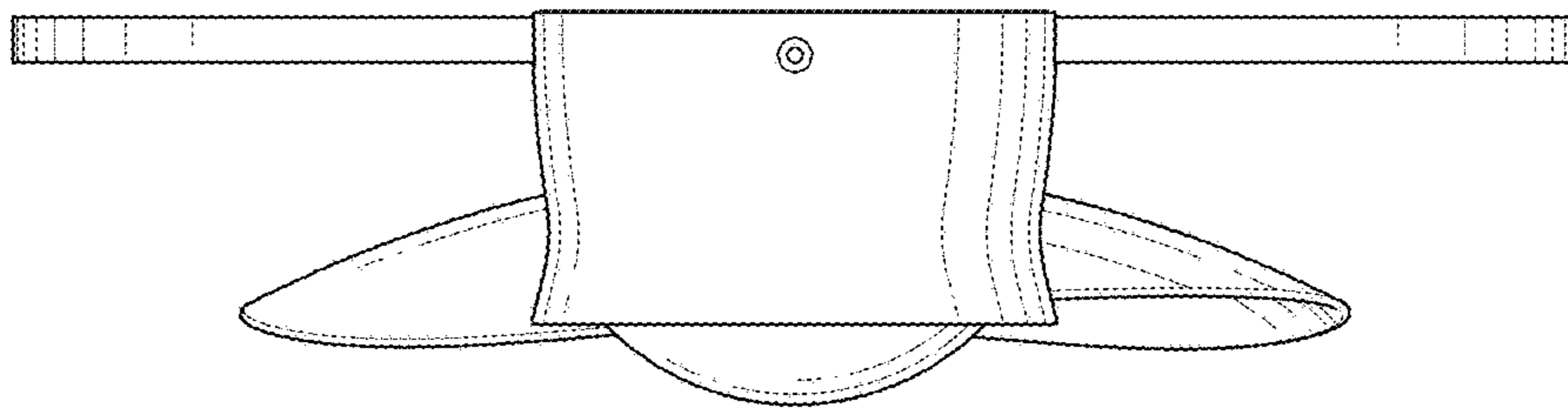

*Fig. 6*

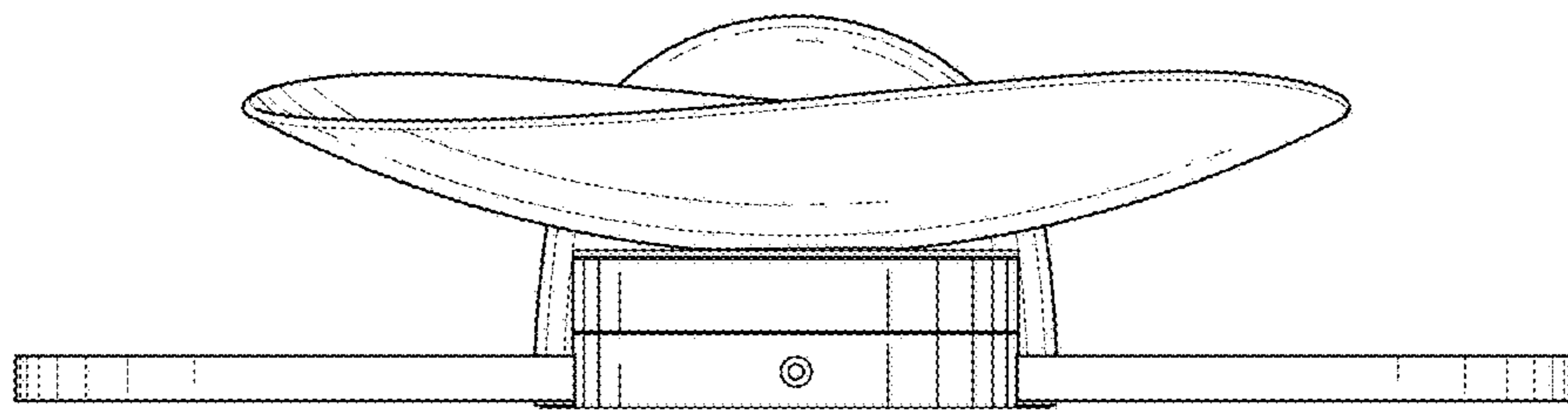

*Fig. 7*