



US00D862748S

(12) **United States Design Patent**
Zuo

(10) **Patent No.:** **US D862,748 S**

(45) **Date of Patent:** **** Oct. 8, 2019**

(54) **MUSIC CANDLE LAMP**

D424,219 S * 5/2000 Toscano D26/7
D426,004 S * 5/2000 Toscano D26/7
D750,814 S * 3/2016 Moyal D26/22

(71) Applicant: **Xing Zuo**, Hunan (CN)

* cited by examiner

(72) Inventor: **Xing Zuo**, Hunan (CN)

Primary Examiner — Marcus A Jackson

(**) Term: **15 Years**

(21) Appl. No.: **29/662,483**

(57) **CLAIM**

(22) Filed: **Sep. 6, 2018**

The ornamental design for a music candle lamp, as shown and described.

(51) **LOC (12) Cl.** **26-04**

(52) **U.S. Cl.**
USPC **D26/6**

(58) **Field of Classification Search**
USPC D26/1-7
CPC H01R 5/00; H01R 13/46; H01R 13/514;
H01R 31/048; H01R 31/02; H01J 5/00;
H01J 5/16; H01J 1/02; H01J 15/00; H01J
5/48; H01J 5/50; H01J 19/54; F21V 5/00;
F21K 9/00; F21K 13/00
See application file for complete search history.

DESCRIPTION

FIG. 1 is a perspective view of a music candle lamp showing my new design;
FIG. 2 is a front elevational view thereof;
FIG. 3 is a rear elevational view thereof;
FIG. 4 is a left side elevational view thereof;
FIG. 5 is a right side elevational view thereof;
FIG. 6 is a top plan view thereof;
FIG. 7 is a bottom plan view thereof; and,
FIG. 8 is another perspective view thereof, showing a music candle lamp in use status and all the light stands are unfolded.

(56) **References Cited**

U.S. PATENT DOCUMENTS

D423,693 S * 4/2000 Toscano D26/7
D423,694 S * 4/2000 Ruffolo D26/7

1 Claim, 8 Drawing Sheets

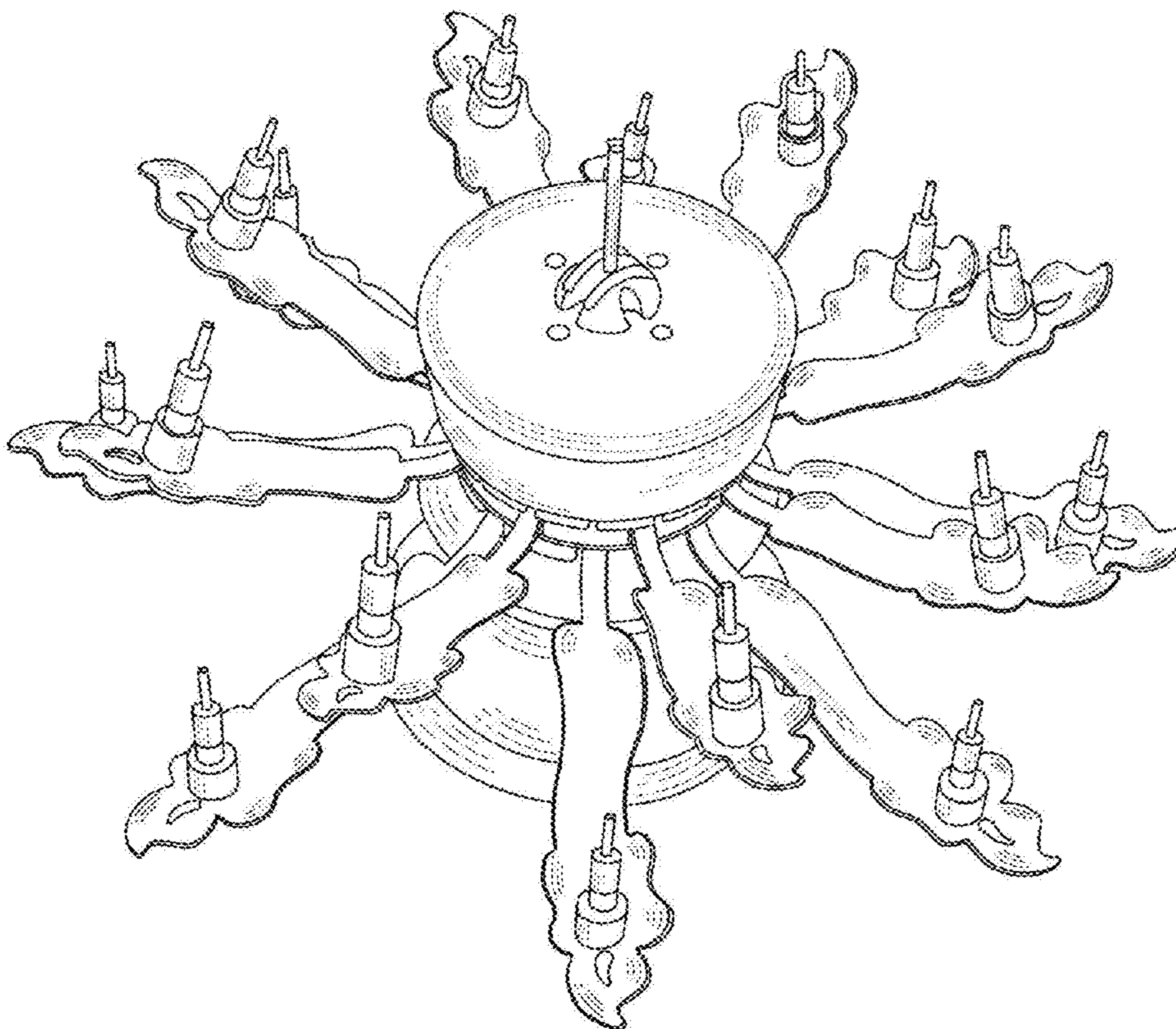



FIG.1

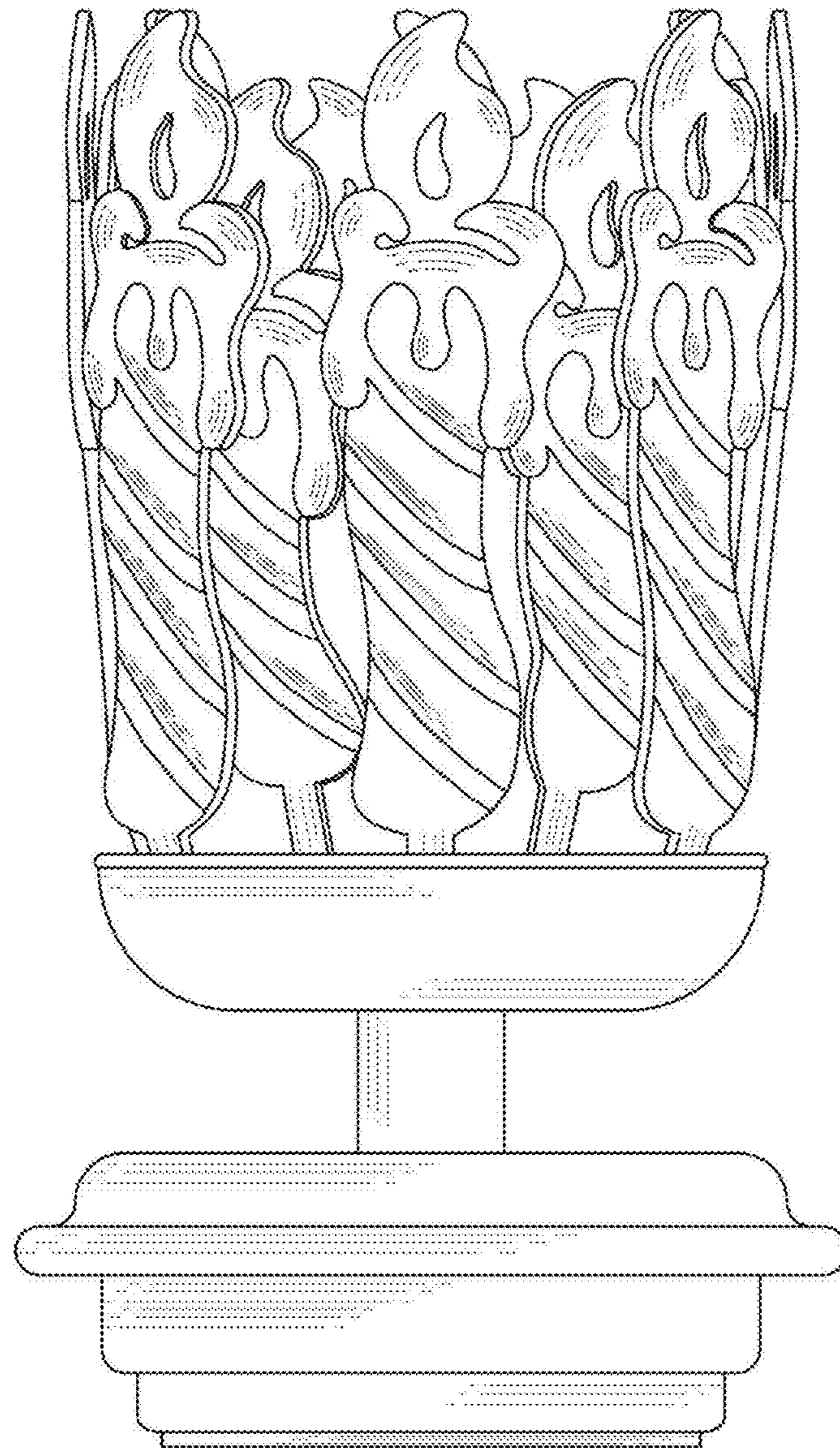

FIG.2

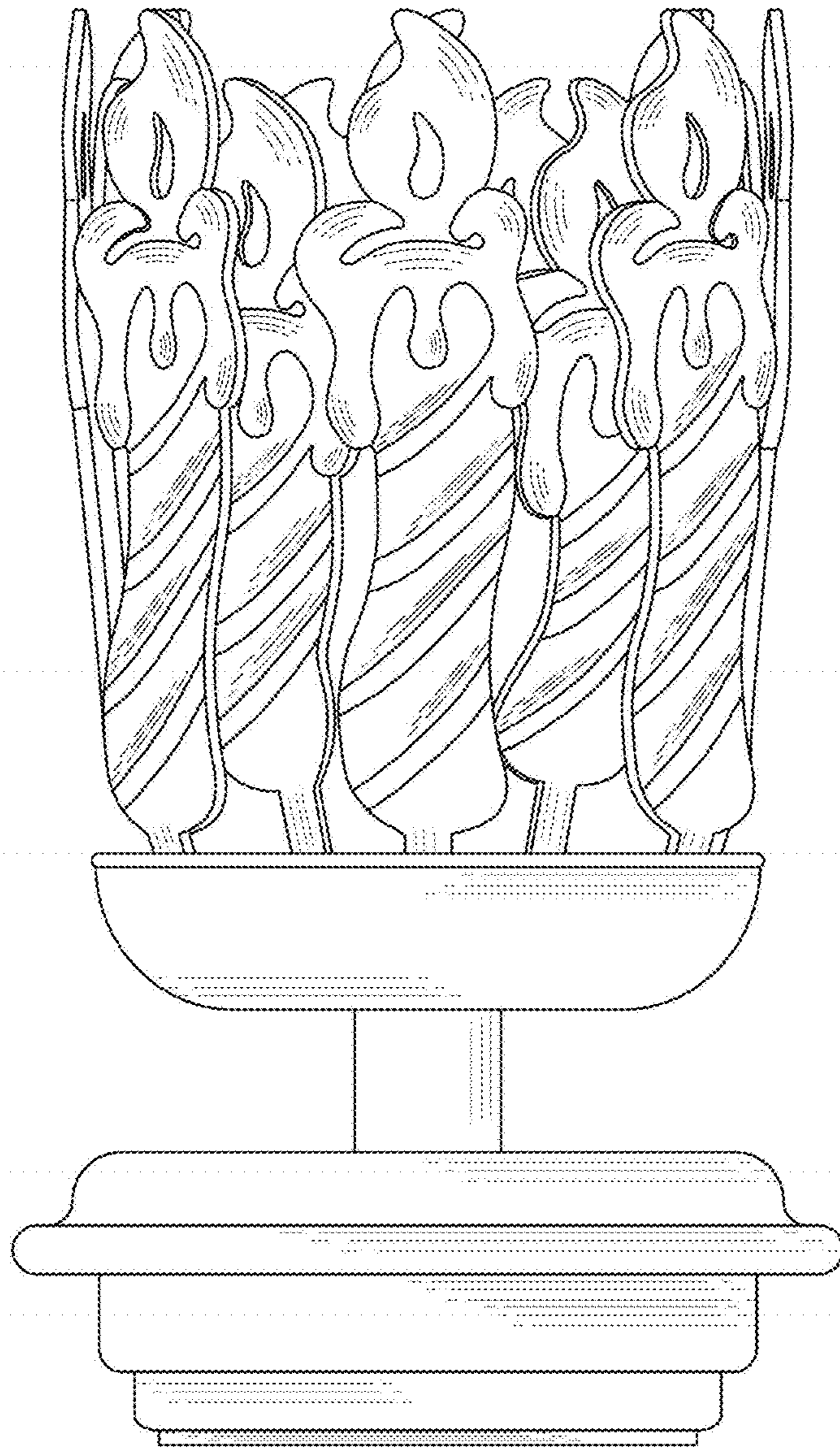

FIG.3

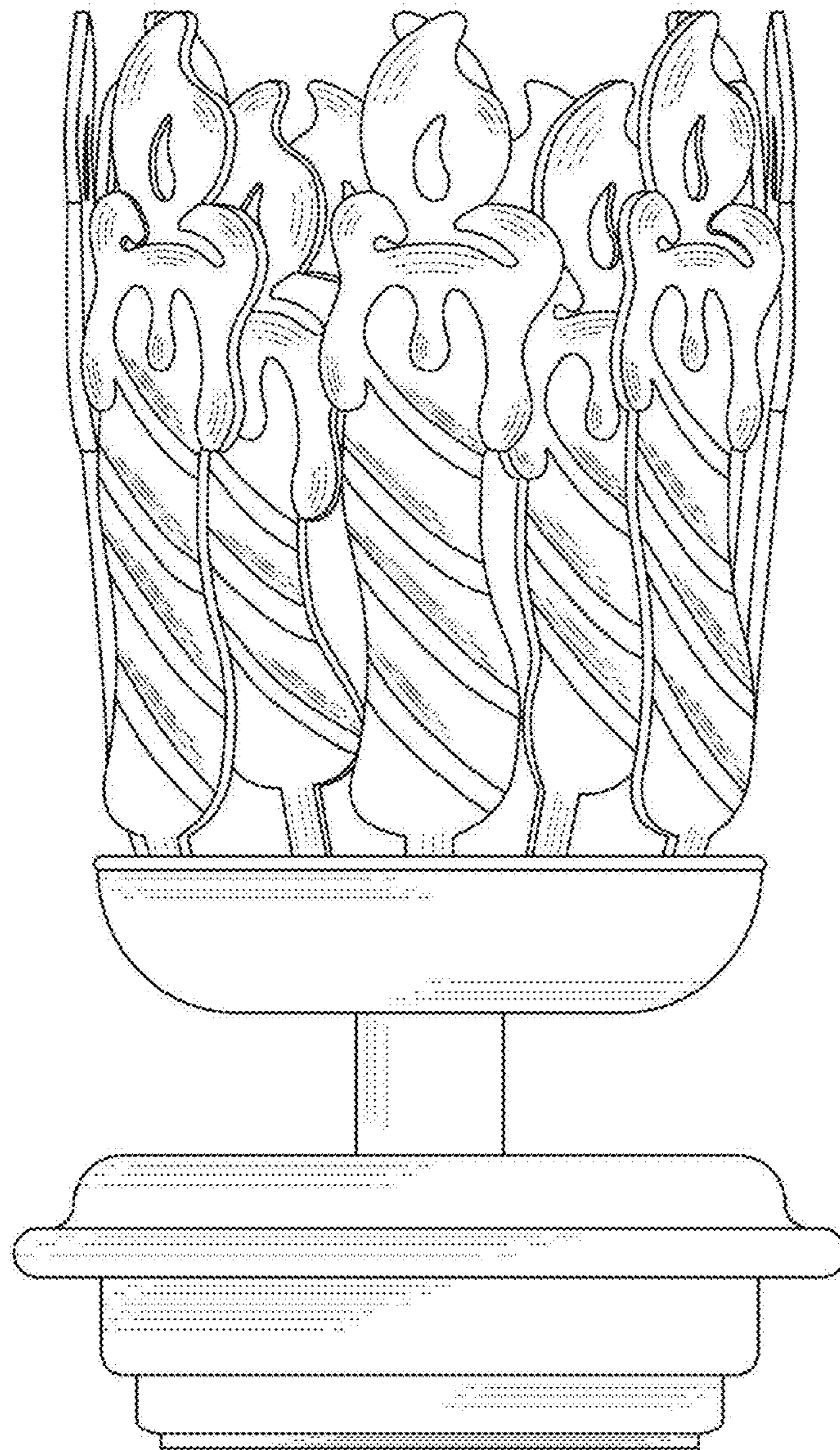

FIG.4

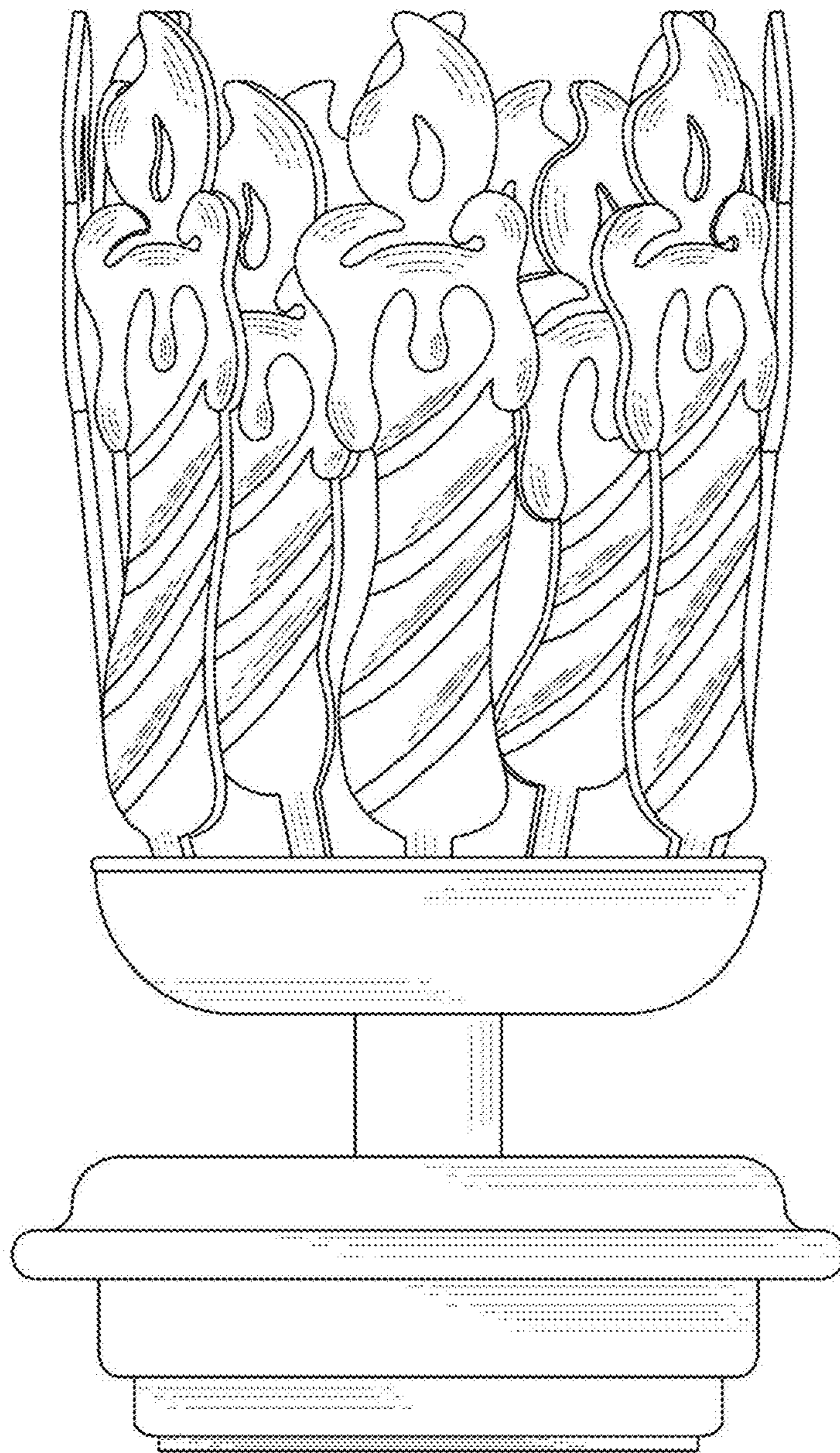

FIG.5

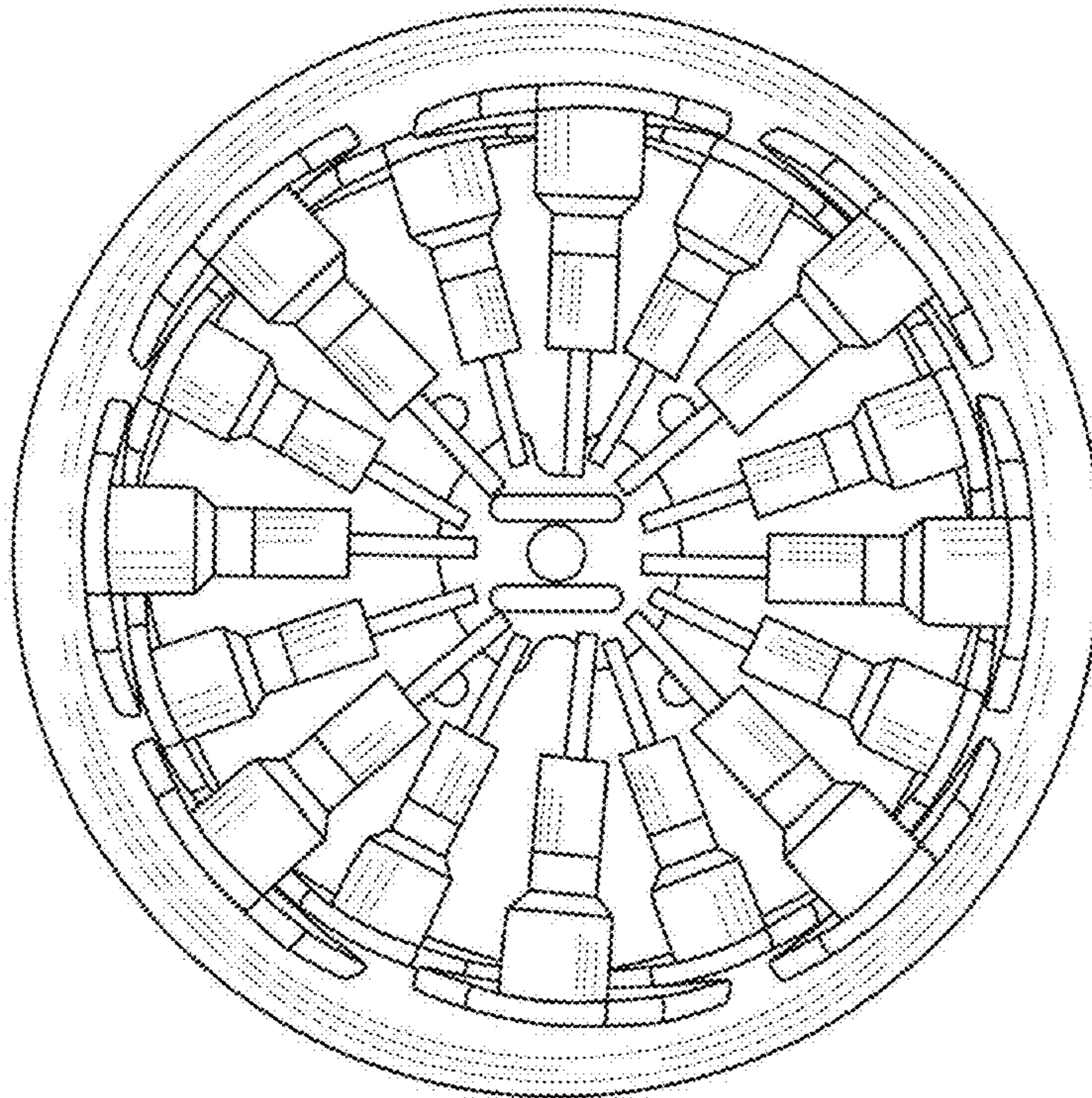

FIG.6

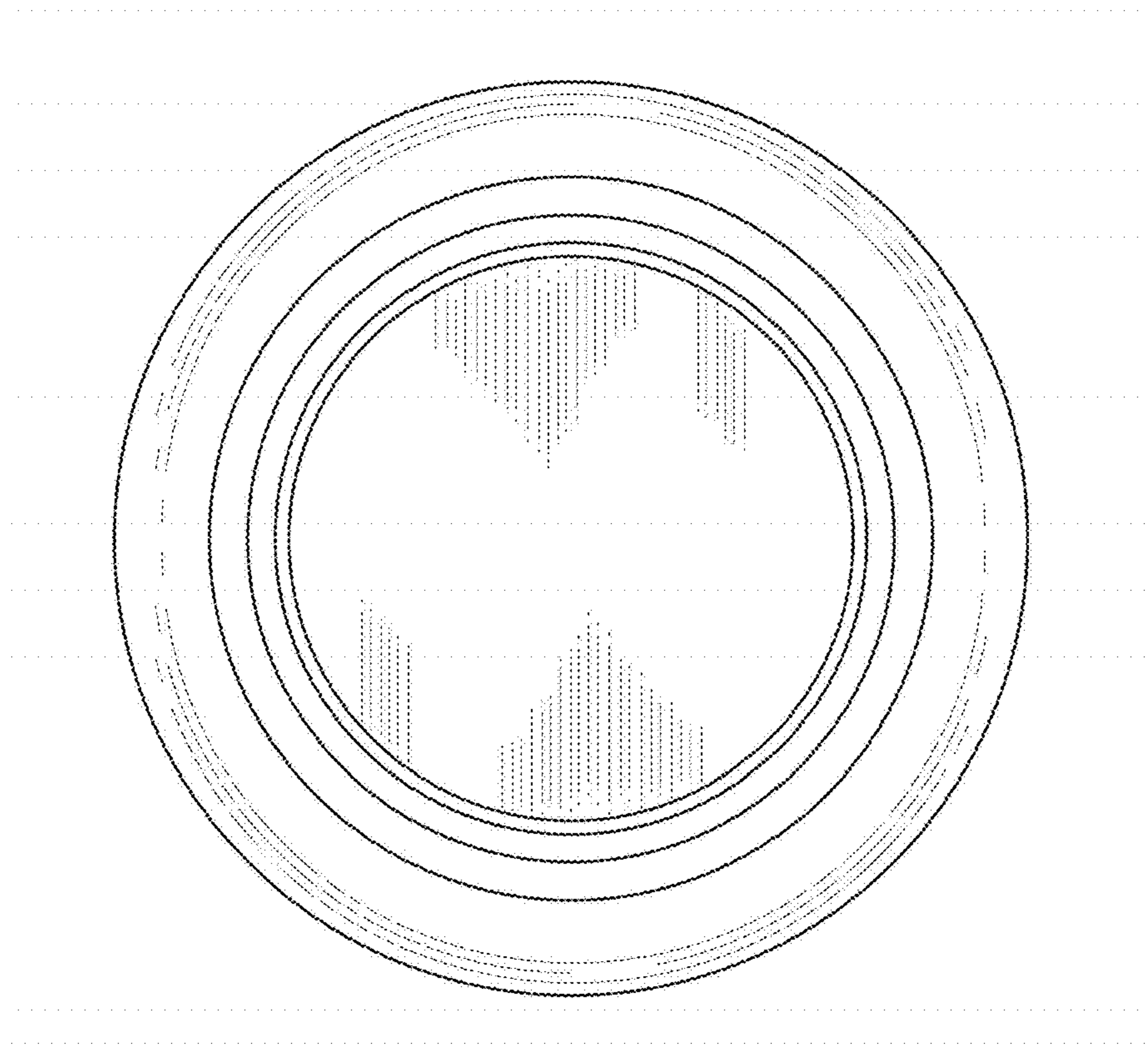

FIG. 7

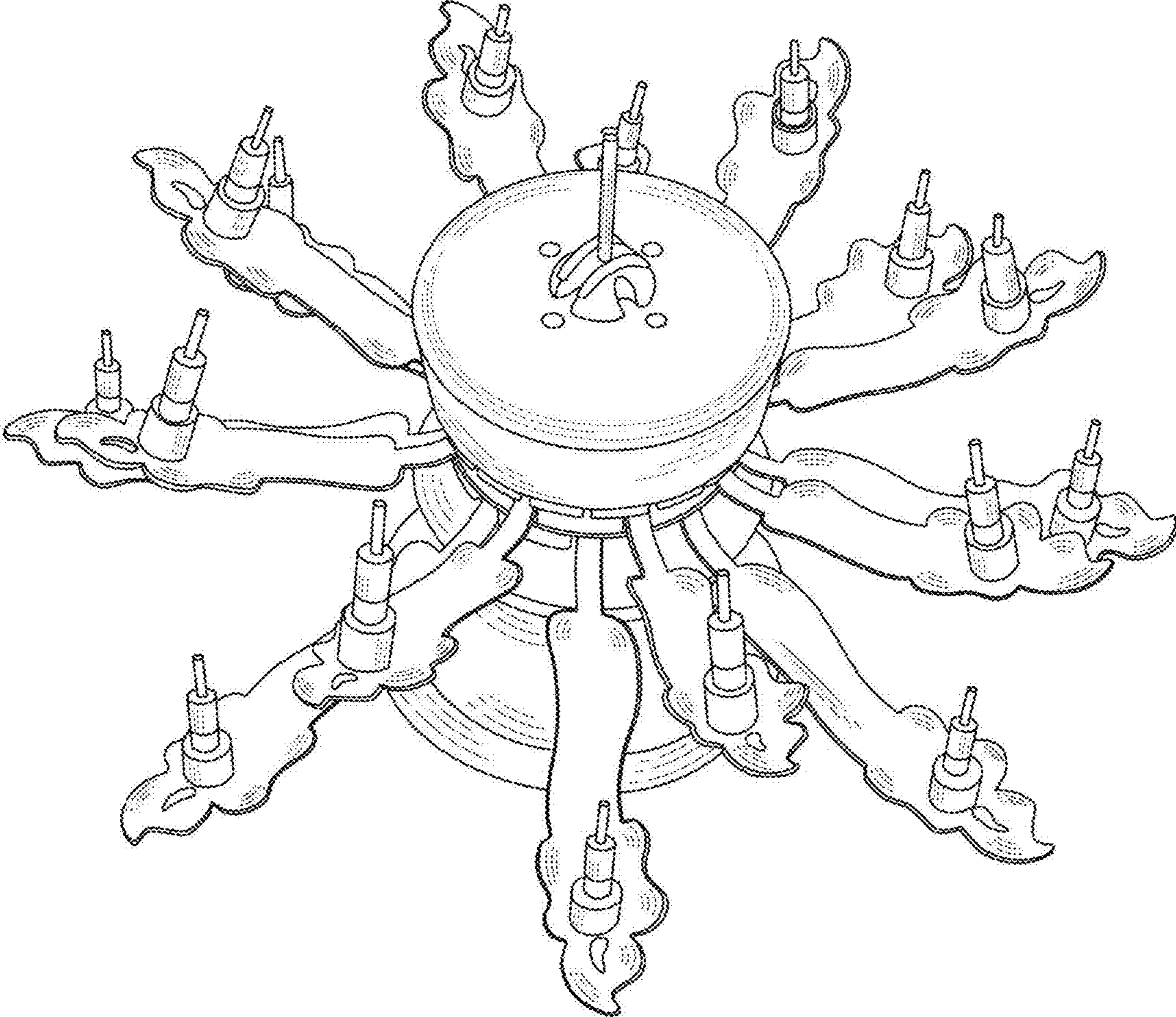

FIG. 8