

US00D862746S

(12) **United States Design Patent**
Cai

(10) **Patent No.:** **US D862,746 S**

(45) **Date of Patent:** **** Oct. 8, 2019**

(54) **LED LAMP**

(71) Applicant: **Guanlin Cai**, Guangdong (CN)

(72) Inventor: **Guanlin Cai**, Guangdong (CN)

(**) Term: **15 Years**

(21) Appl. No.: **29/656,668**

(22) Filed: **Jul. 15, 2018**

(51) **LOC (12) Cl.** **26-04**

(52) **U.S. Cl.**
USPC **D26/2**

(58) **Field of Classification Search**

USPC D26/1-4

CPC H01R 5/00; H01R 13/46; H01R 13/514;

H01R 31/048; H01R 31/02; H01J 5/00;

H01J 5/16; H01J 1/02; H01J 15/00; H01J

5/48; H01J 5/50; H01J 19/54; F21V 5/00;

F21K 9/00; F21K 13/00

See application file for complete search history.

(56) **References Cited**

U.S. PATENT DOCUMENTS

D334,990 S * 4/1993 Sekiguchi D26/1

D508,575 S * 8/2005 Buschmann D26/2

D534,665 S * 1/2007 Egawa D26/2

D645,580 S * 9/2011 Yoshinobu D26/2

D647,226 S * 10/2011 Huang D26/2

D667,568 S * 9/2012 Chen D26/1

* cited by examiner

Primary Examiner — Marcus A Jackson

(57) **CLAIM**

The ornamental design for a LED lamp, as shown and described.

DESCRIPTION

FIG. 1 is a front, top and right side perspective view of a LED lamp showing my new design;

FIG. 2 is a rear, bottom and left side perspective view thereof;

FIG. 3 is a top elevational view thereof;

FIG. 4 is a bottom elevational view thereof;

FIG. 5 is a right side elevational view thereof;

FIG. 6 is a left side elevational view thereof;

FIG. 7 is a front plan view thereof; and,

FIG. 8 is a rear plan view thereof.

The broken lines shown in LED lamp form no part of the claimed design.

1 Claim, 8 Drawing Sheets

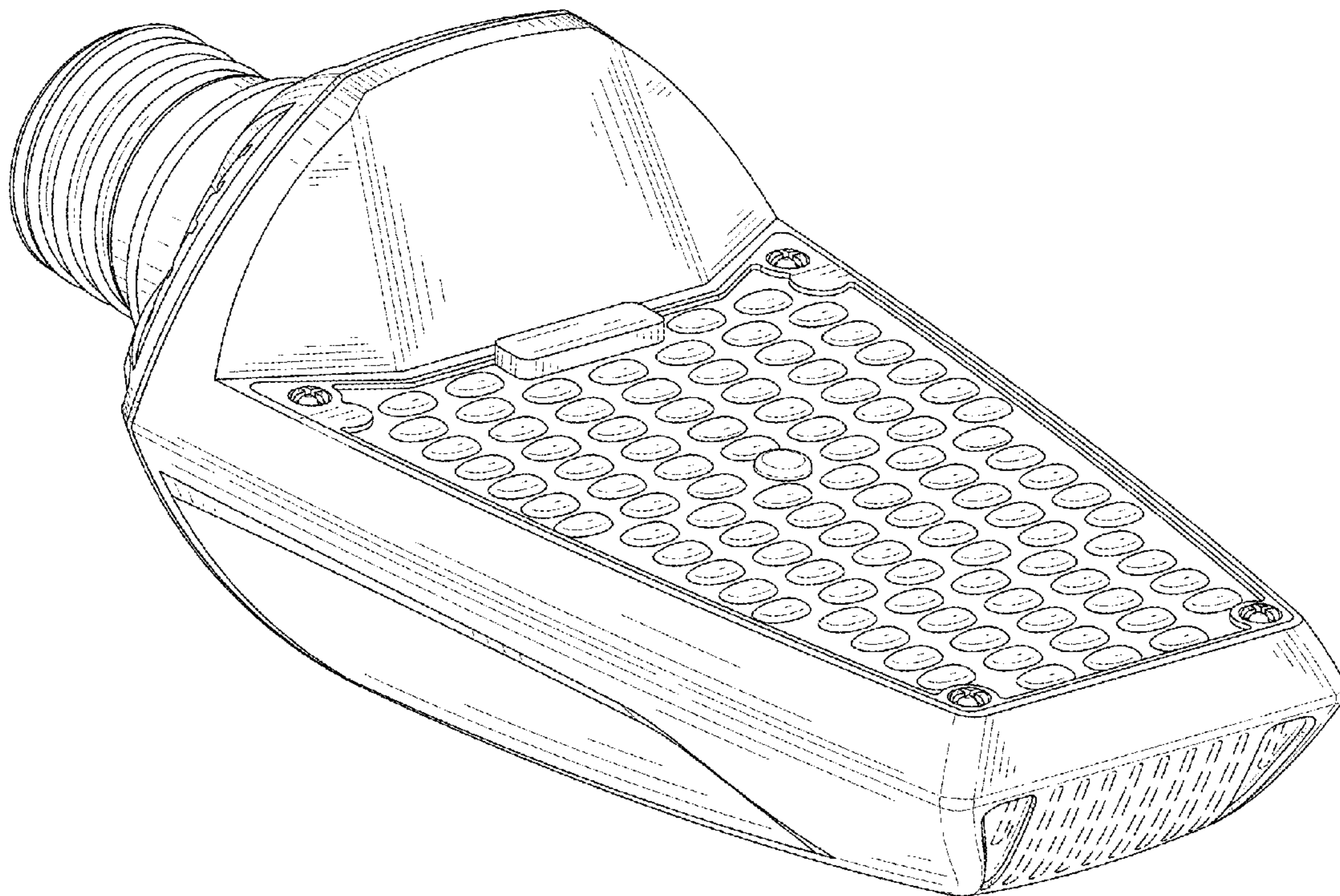

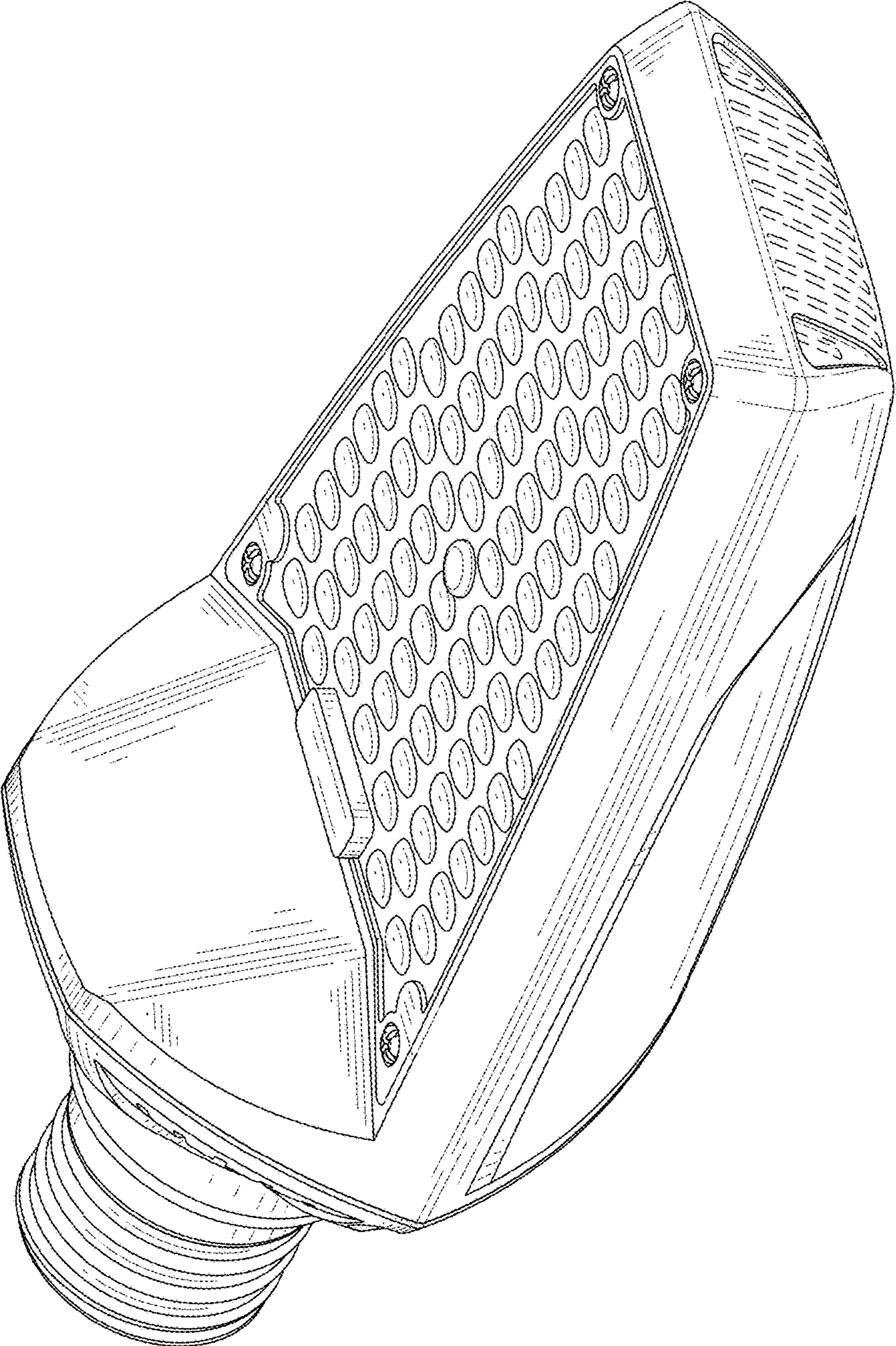

FIG. 1

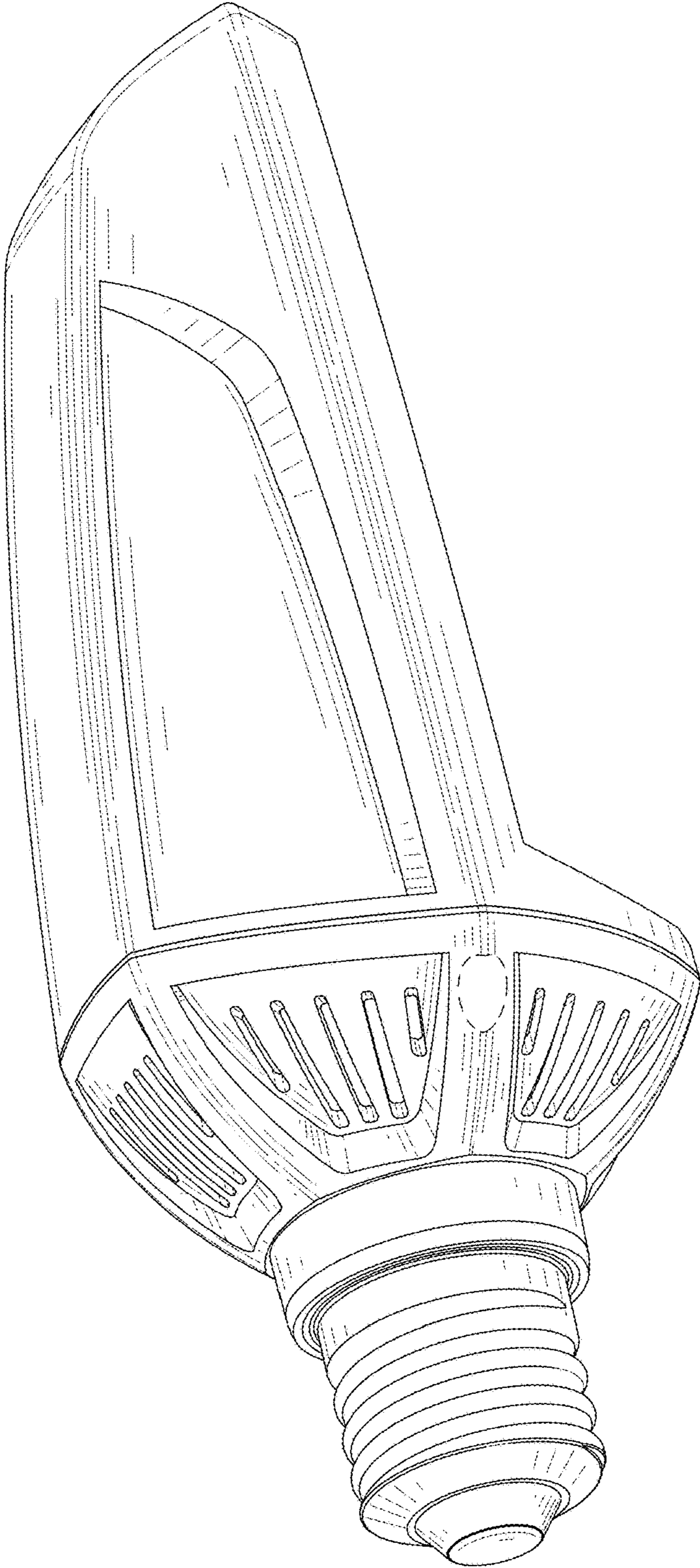

FIG. 2

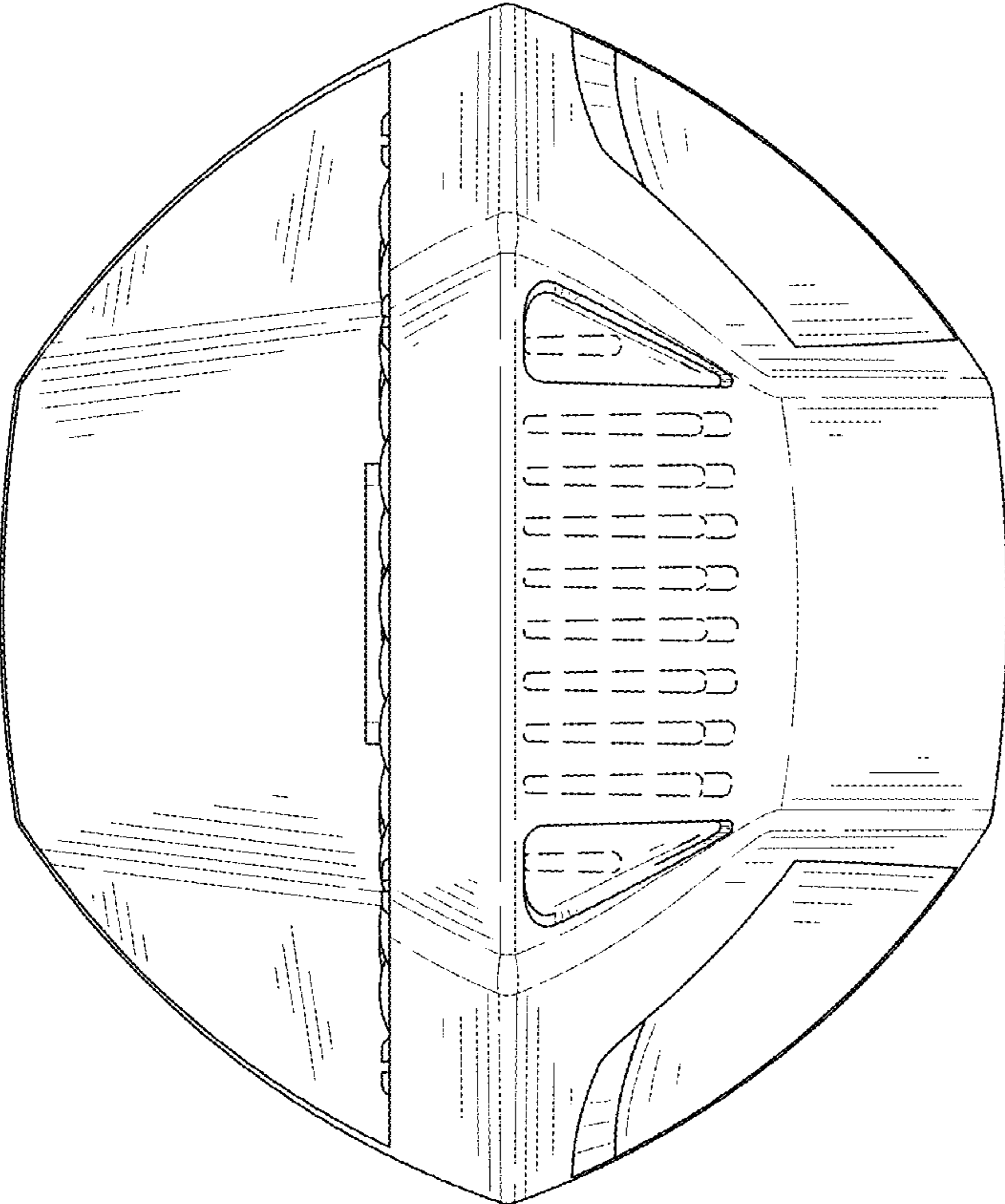

FIG. 3

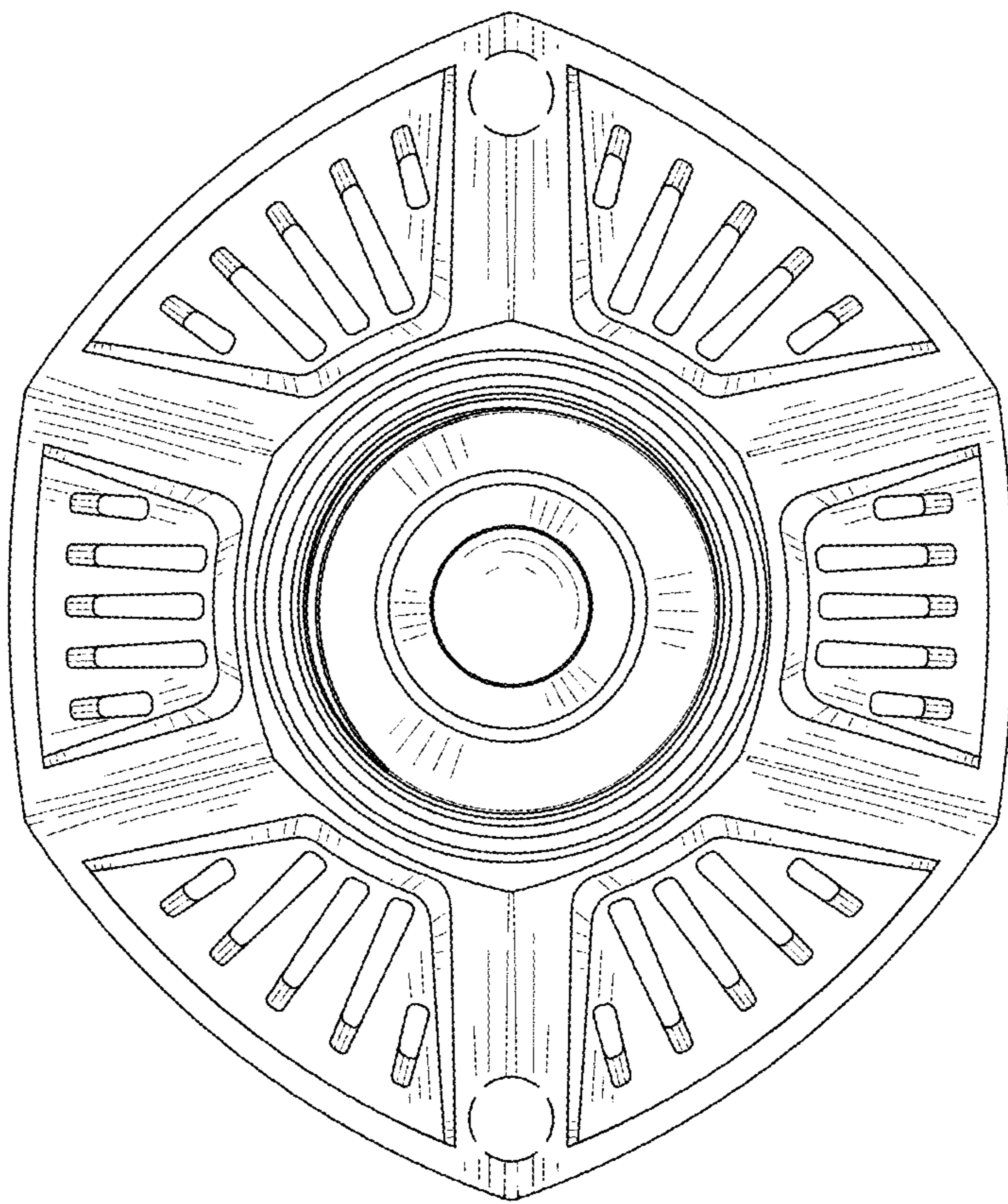

FIG. 4

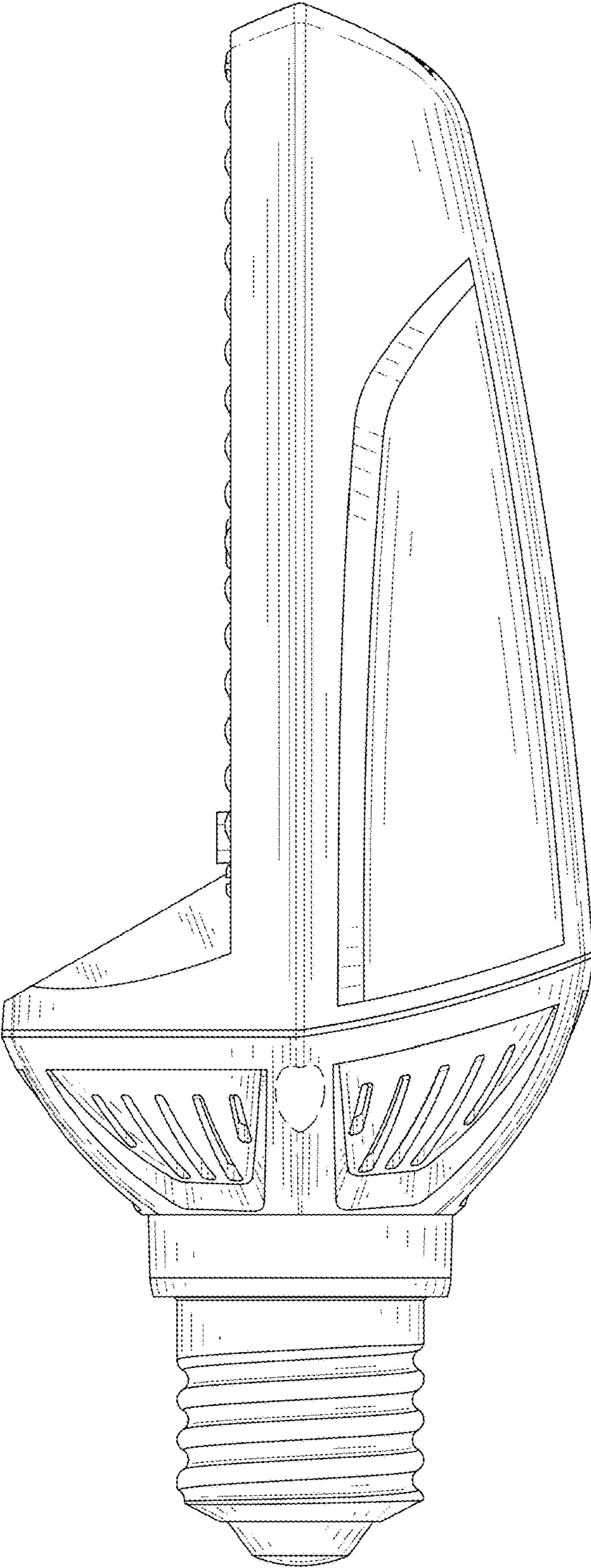

FIG. 5

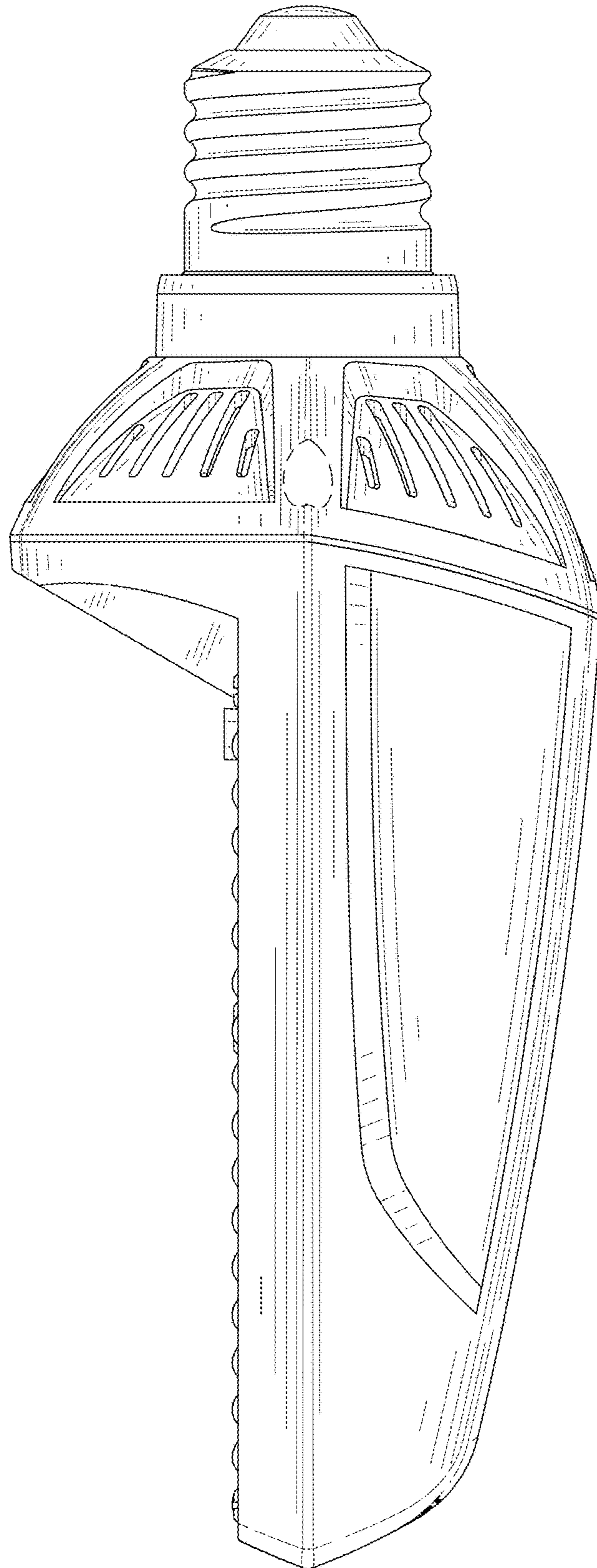

FIG. 6

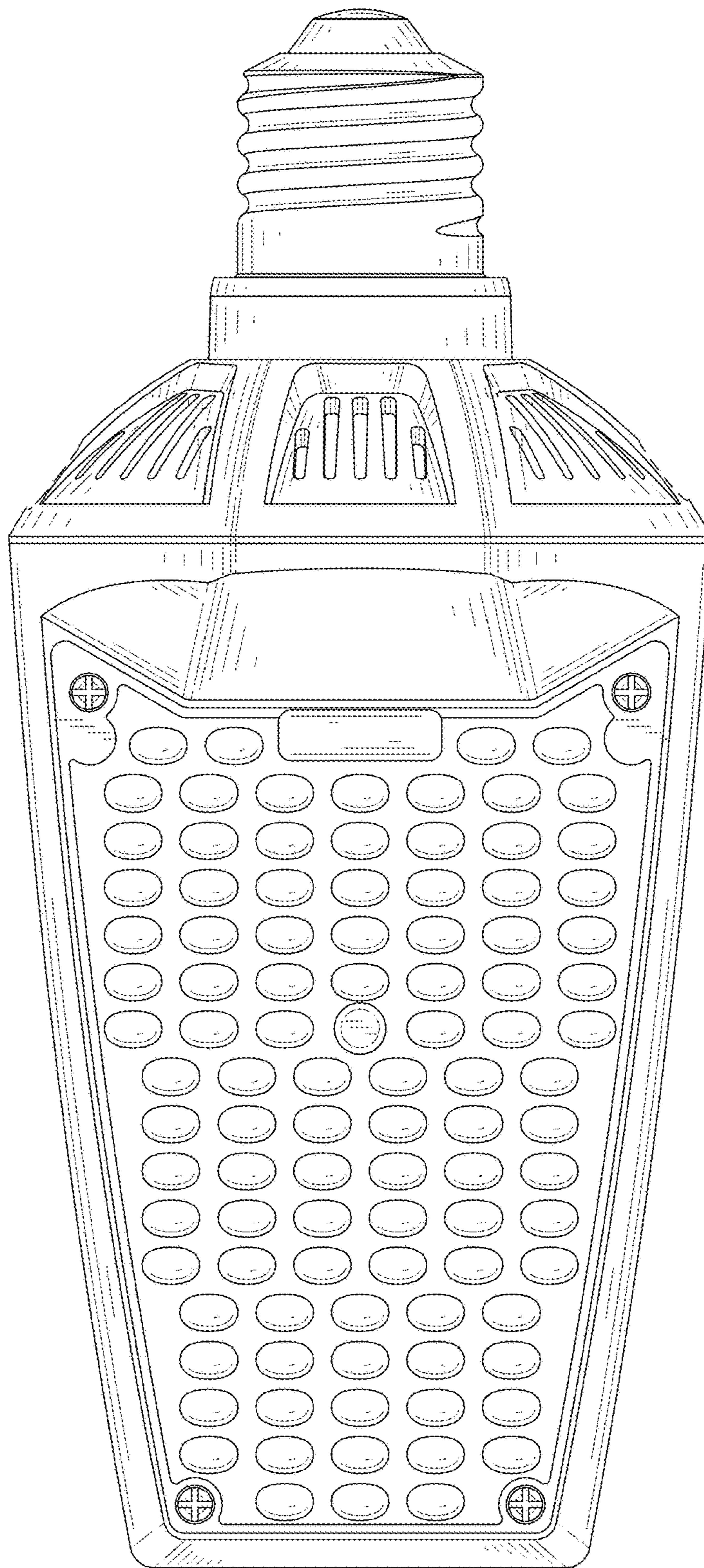

FIG. 7

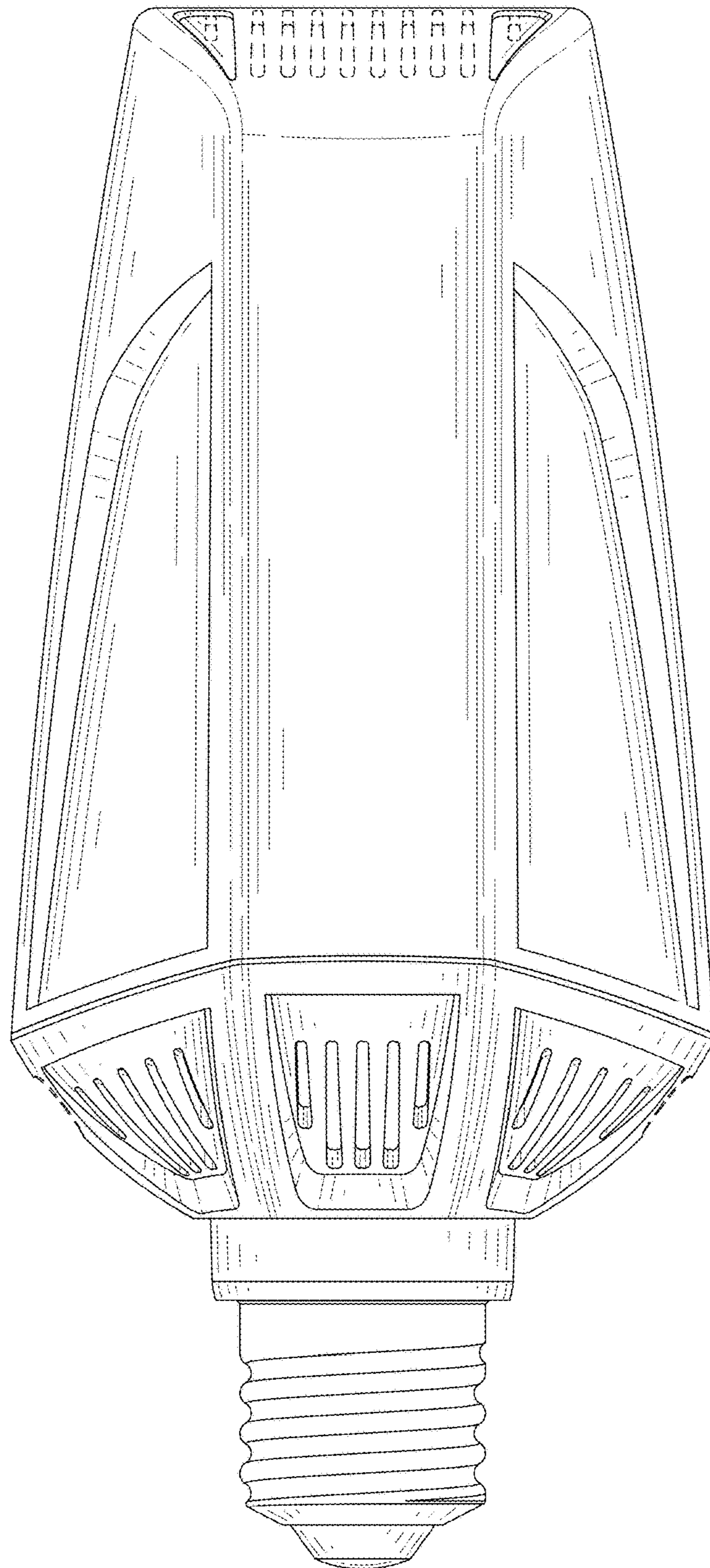

FIG. 8