

US00D862685S

(12) **United States Design Patent** (10) **Patent No.:** **US D862,685 S**
Carney (45) **Date of Patent:** **** Oct. 8, 2019**

- (54) **ANESTHESIA CHARACTER MASK FOR CHILDREN**
- (71) Applicant: **Michael Carney**, Lexington, KY (US)
- (72) Inventor: **Michael Carney**, Lexington, KY (US)
- (73) Assignee: **Michael Carney**, Lexington, KY (US)
- (**) Term: **15 Years**
- (21) Appl. No.: **29/633,388**
- (22) Filed: **Jan. 12, 2018**
- (51) **LOC (12) Cl.** **29-02**
- (52) **U.S. Cl.**
USPC **D24/110.4**
- (58) **Field of Classification Search**
USPC D24/110.1–110.4, 110, 110.5–110.6, 112, D24/127–128, 164; D21/660
CPC A61M 16/06; A61M 16/0683; A61M 16/0816; A61M 16/0875; A61M 16/208; A61M 16/00; A62B 18/02; A62B 18/10
See application file for complete search history.

2007/0107723	A1*	5/2007	Berg	A61M 16/047	128/200.26
2009/0250064	A1*	10/2009	Strawder	A61M 16/06	128/207.11
2012/0090616	A1*	4/2012	Means	A41D 13/1192	128/206.19

OTHER PUBLICATIONS

Sami the Seal Pediatric Nebulizer Mask. Just Nebulizers. Date reviewed: Sep. 4, 2014. Retrieved from Internet: <<https://justnebulizers.com/sami-the-seal-pediatric-nebulizer-mask.html>> (Year: 2014).*

Spotz Pediatric Nebulizer Mask. RehabMart.com. Web archive date: May 2, 2012. Retrieved from Internet: <<https://web.archive.org/web/20120502111651/https://www.rehabmart.com/product/spotz-pediatric-nebulizer-mask-33678.html>> (Year: 2012).*

* cited by examiner

Primary Examiner — Karen E Kearney
Assistant Examiner — Lilyana Bekic

(57) **CLAIM**

The ornamental design for an anesthesia character mask for children, as shown and described.

DESCRIPTION

FIG. 1 is a front perspective view of an anesthesia character mask for children showing my new design;
FIG. 2 is a front view thereof;
FIG. 3 is a rear view thereof;
FIG. 4 is a left side view thereof;
FIG. 5 is a right side view thereof;
FIG. 6 is a top view thereof; and,
FIG. 7 is a bottom view thereof.
The broken lines in FIG. 3 depict portions of the anesthesia character mask for children that form no part of the claimed design.

1 Claim, 7 Drawing Sheets

(56) **References Cited**

U.S. PATENT DOCUMENTS

D184,302	S *	1/1959	Cooper	D21/660
6,758,215	B2 *	7/2004	Begum	A41D 13/1161
					128/202.15
6,860,268	B2 *	3/2005	Bohn	A61M 16/06
					128/200.24
D536,442	S *	2/2007	Berg	D24/110.1
7,726,314	B1 *	6/2010	Ming	A61M 16/06
					128/202.27
D780,907	S *	3/2017	Bouie	D24/110.1
2003/0145859	A1 *	8/2003	Bohn	A61M 16/06
					128/206.24
2005/0092325	A1 *	5/2005	Dionne	A61M 16/08
					128/205.25

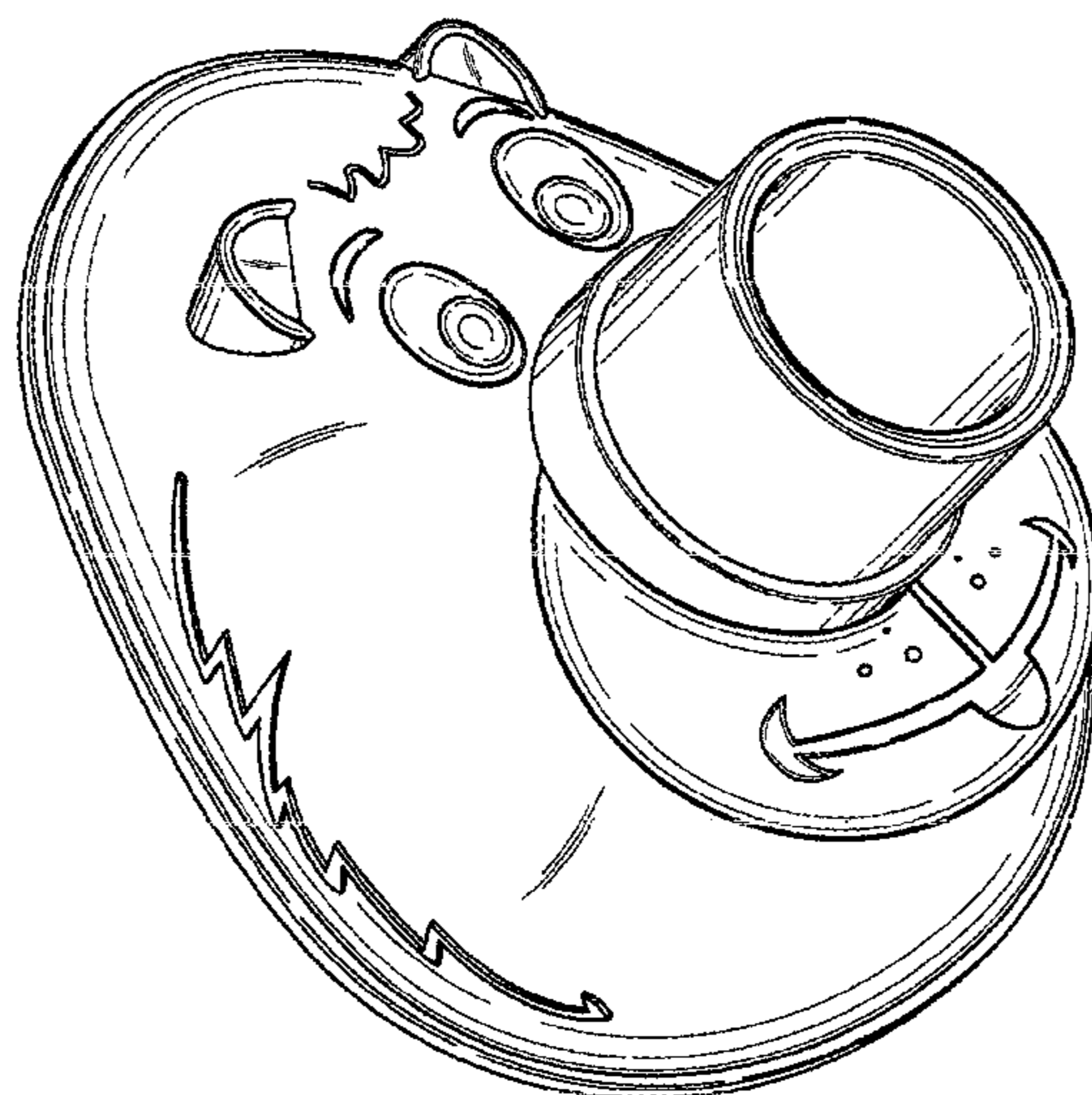

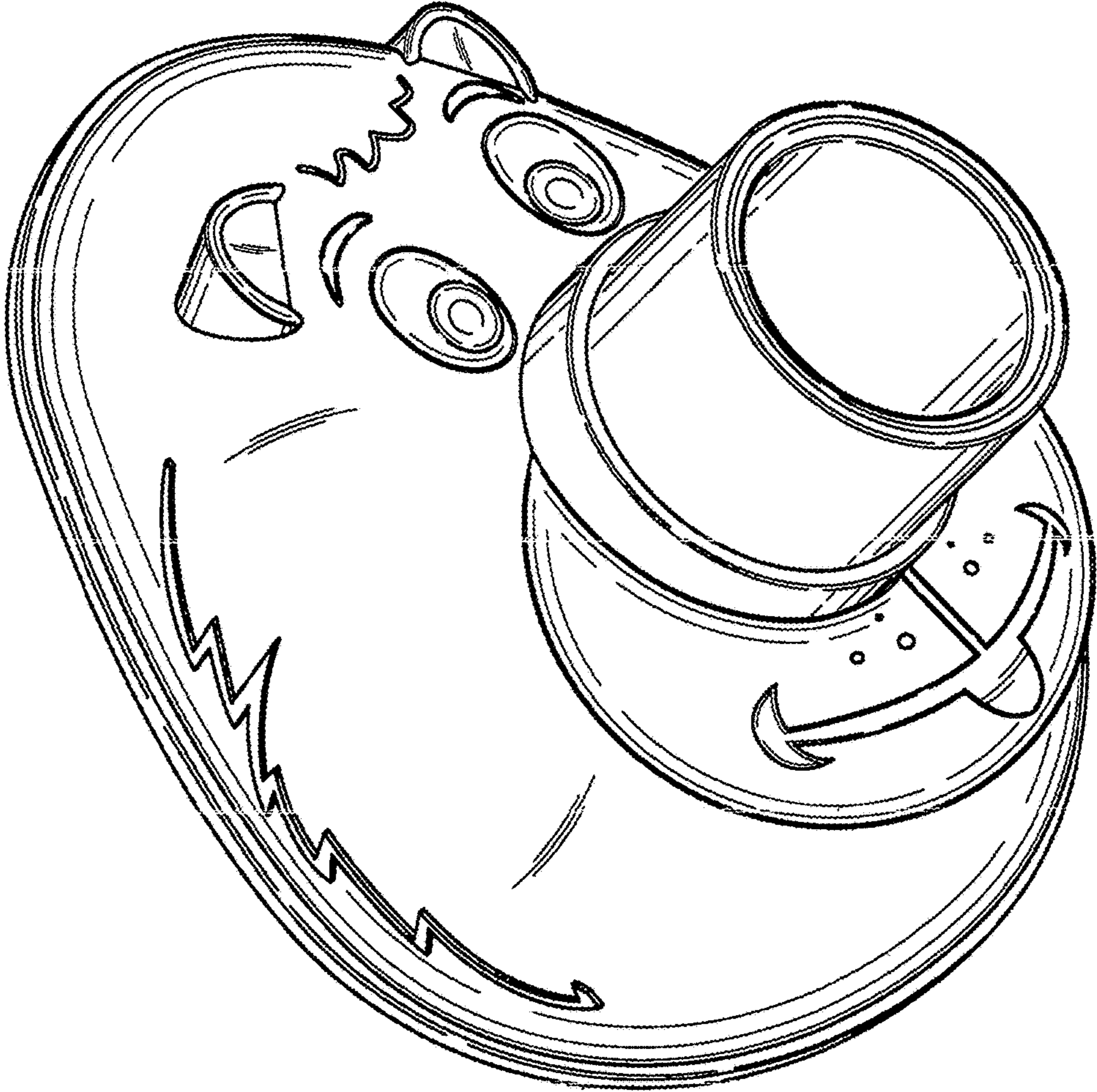

FIG. 1

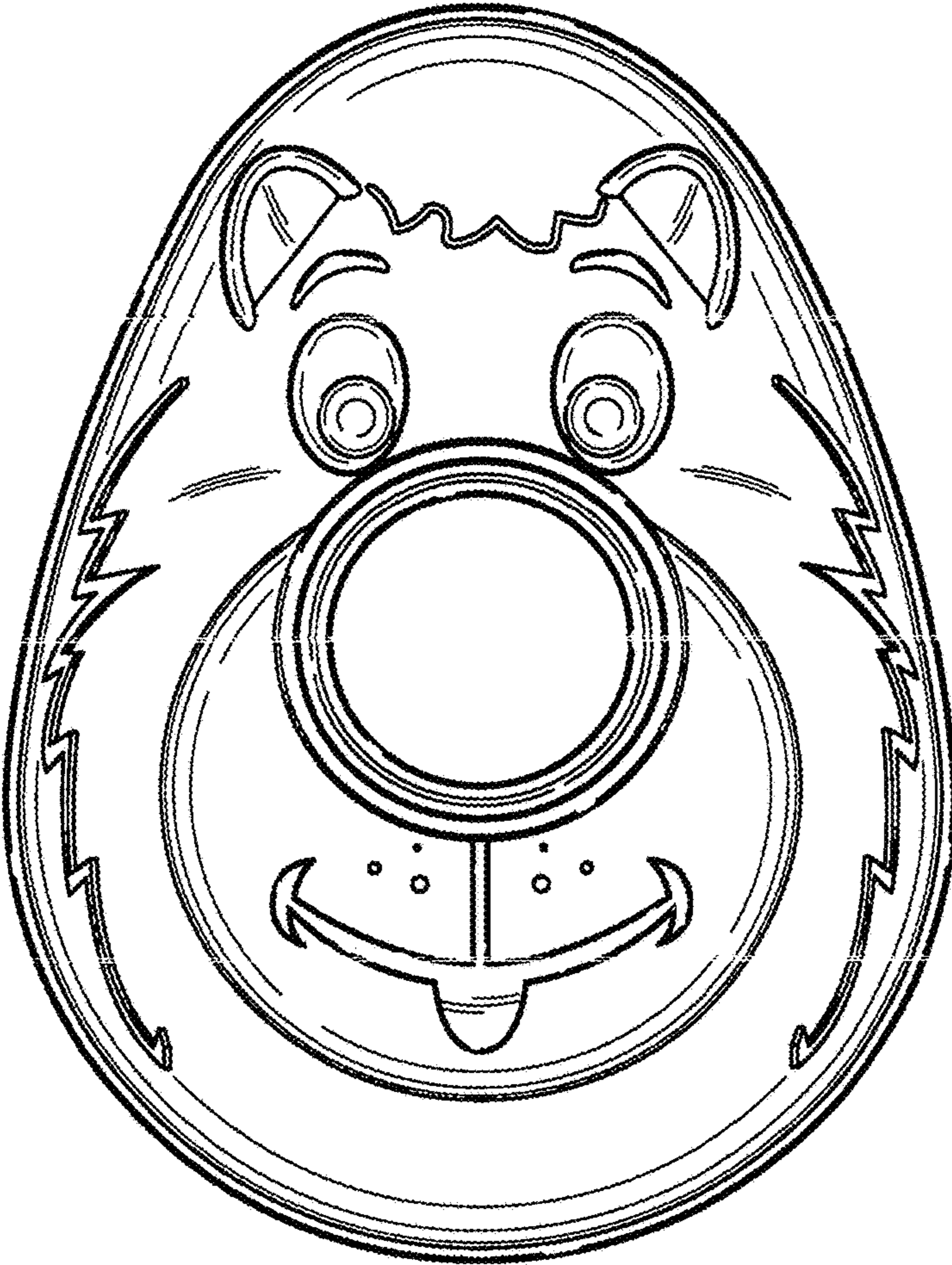

FIG. 2

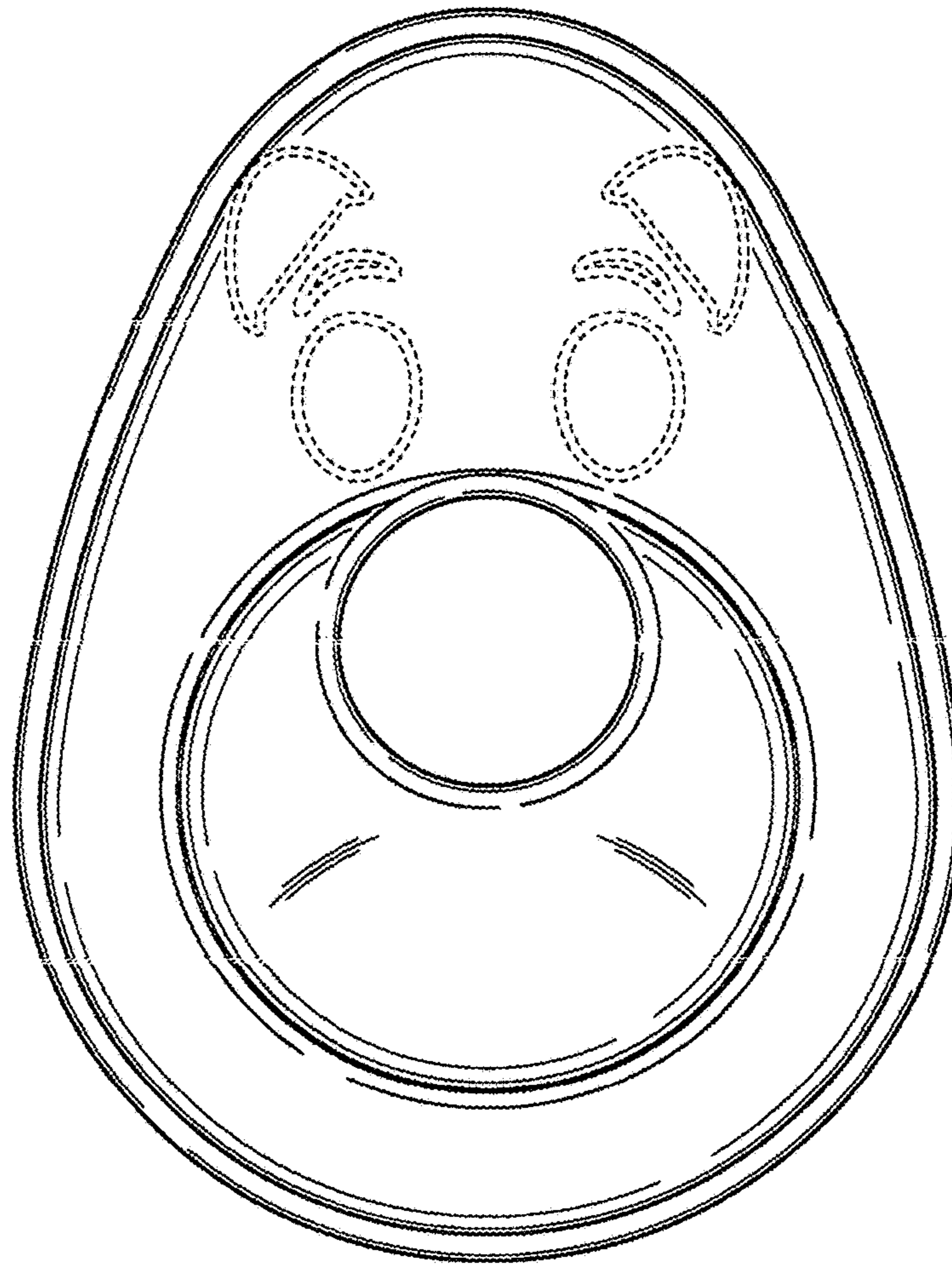

FIG. 3

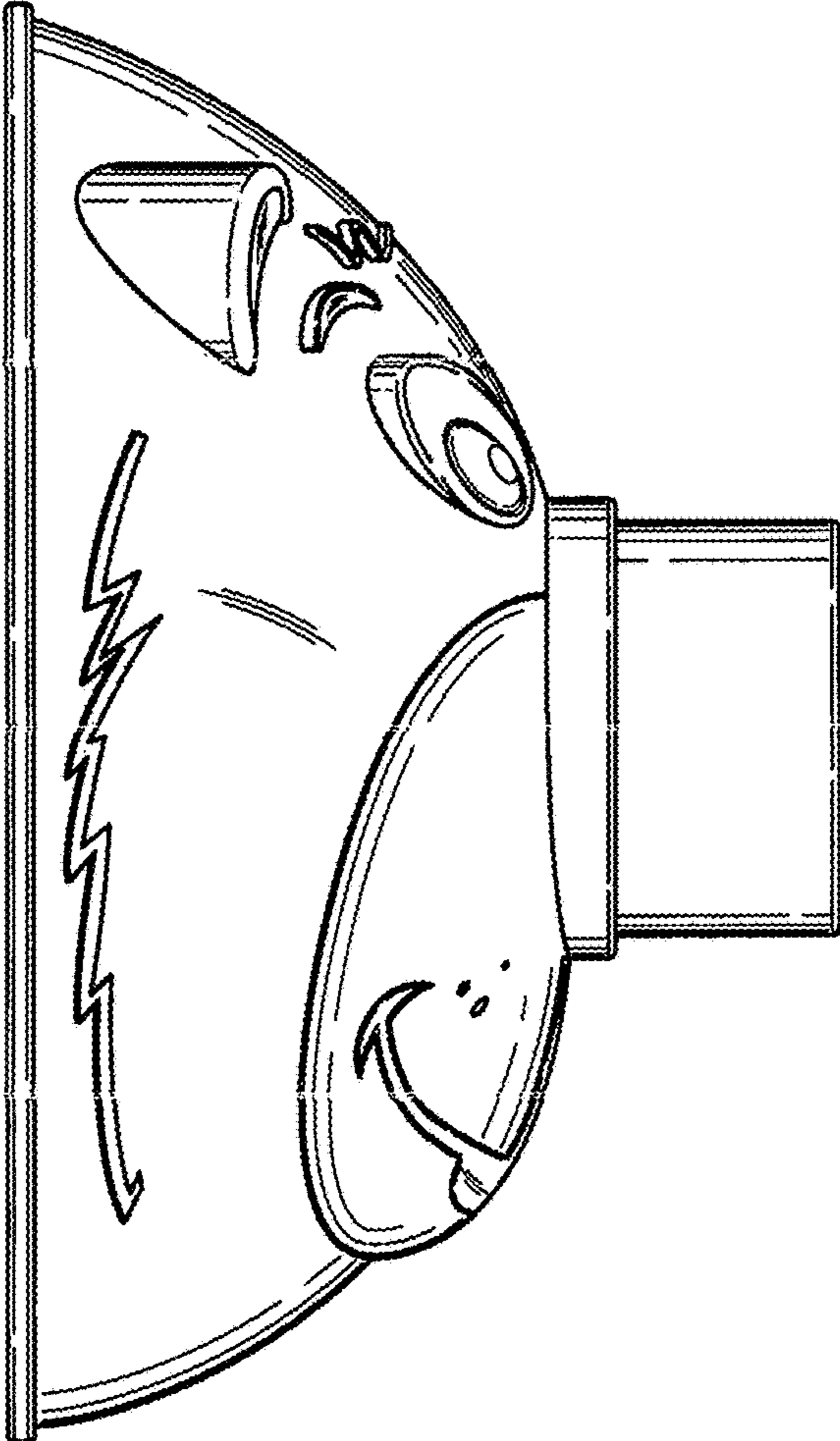

FIG. 4

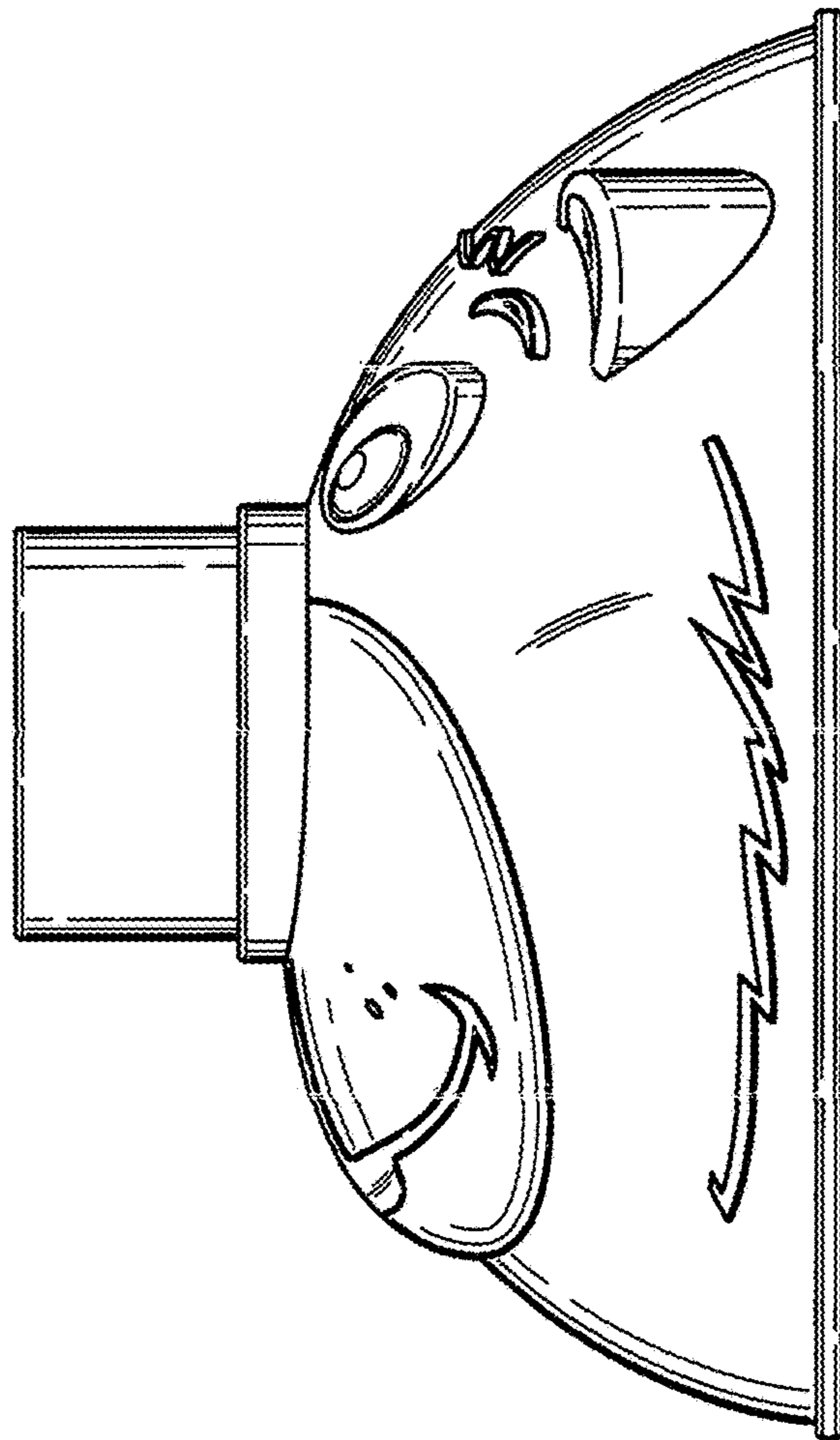

FIG. 5

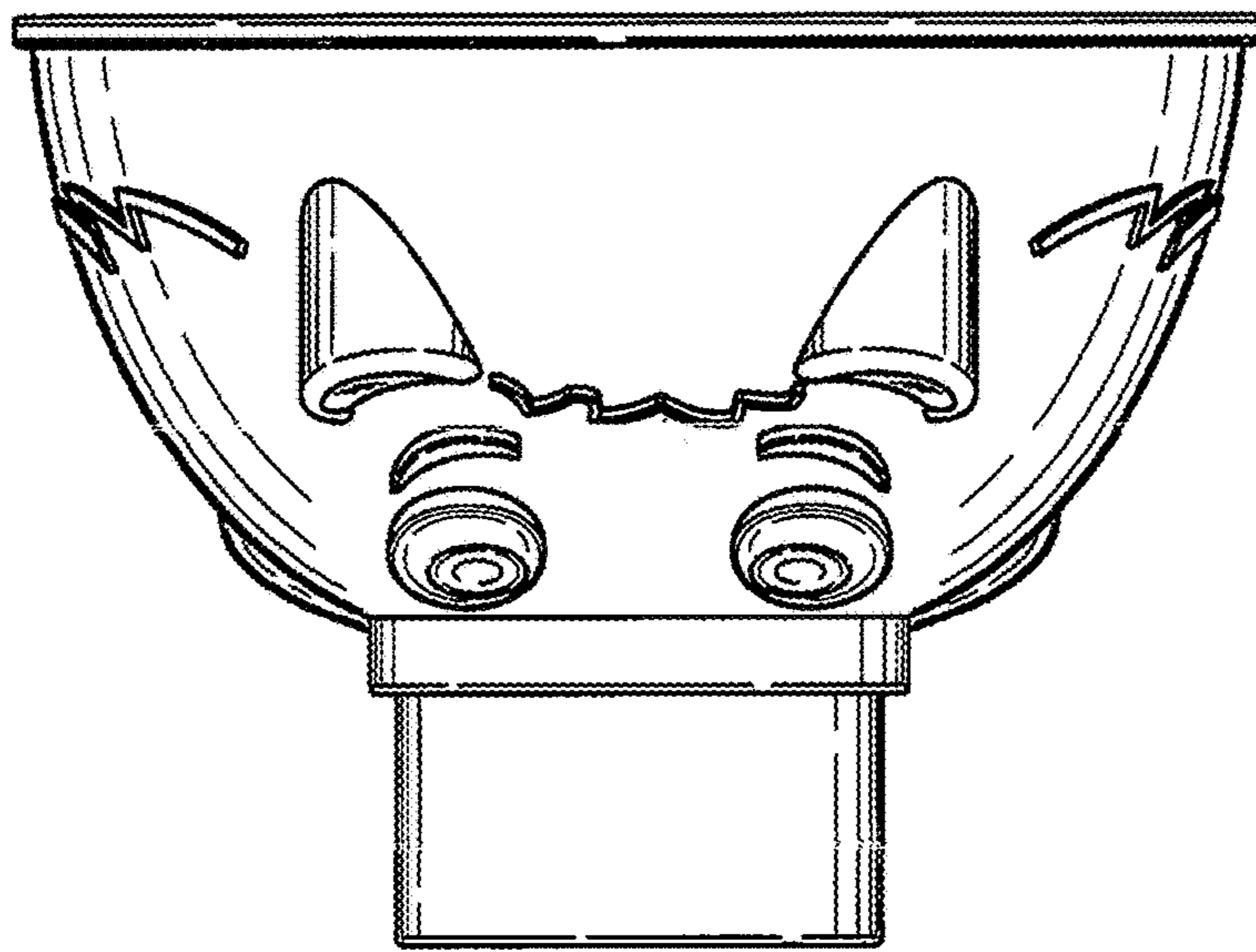

FIG. 6

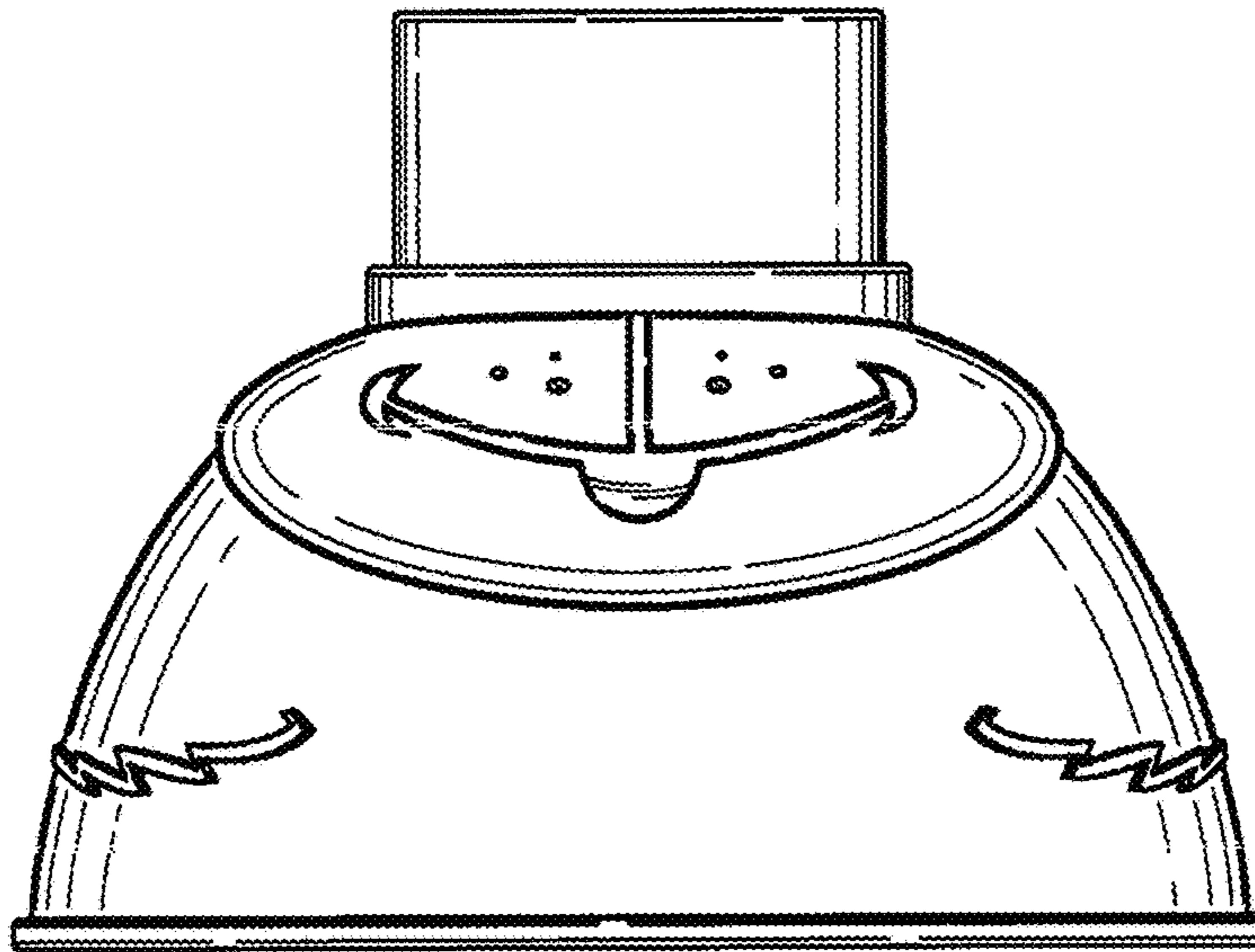

FIG. 7