

US00D862615S

(12) **United States Design Patent**  
**Green**

(10) **Patent No.:** **US D862,615 S**

(45) **Date of Patent:** **\*\* Oct. 8, 2019**

(54) **TOY FIGURINE**

(71) Applicant: **Edwin Green**, District Heights, MD  
(US)

(72) Inventor: **Edwin Green**, District Heights, MD  
(US)

(\*\*) Term: **15 Years**

(21) Appl. No.: **29/658,313**

(22) Filed: **Jul. 30, 2018**

(51) **LOC (12) Cl.** ..... **21-01**

(52) **U.S. Cl.**  
USPC ..... **D21/627**

(58) **Field of Classification Search**  
USPC ..... D21/621, 627, 632, 625  
CPC ..... A63H 3/00-31  
See application file for complete search history.

(56) **References Cited**

**U.S. PATENT DOCUMENTS**

D327,128 S \* 6/1992 Nightingale ..... D24/198  
D395,474 S \* 6/1998 Burton ..... D21/621

D426,697 S \* 6/2000 Rothschild ..... D3/211  
D426,893 S \* 6/2000 Pfiffner ..... D24/198  
D453,571 S \* 2/2002 Hall ..... D24/199  
D482,744 S \* 11/2003 Krueger ..... D21/621

\* cited by examiner

*Primary Examiner* — Zenia I Bennett

(57) **CLAIM**

The ornamental design for a toy figurine, as shown and described.

**DESCRIPTION**

FIG. 1 is a front elevational view of a toy figurine;  
FIG. 2 is a left side elevational view thereof;  
FIG. 3 is a rear elevational view thereof;  
FIG. 4 is a right side elevational view thereof;  
FIG. 5 is a bottom plan view thereof;  
FIG. 6 is a top plan view thereof; and,  
FIG. 7 is a top perspective view thereof.  
The broken line showing of numbers is included for the purpose of illustrating environmental structure and forms no part of the claimed design.

**1 Claim, 7 Drawing Sheets**

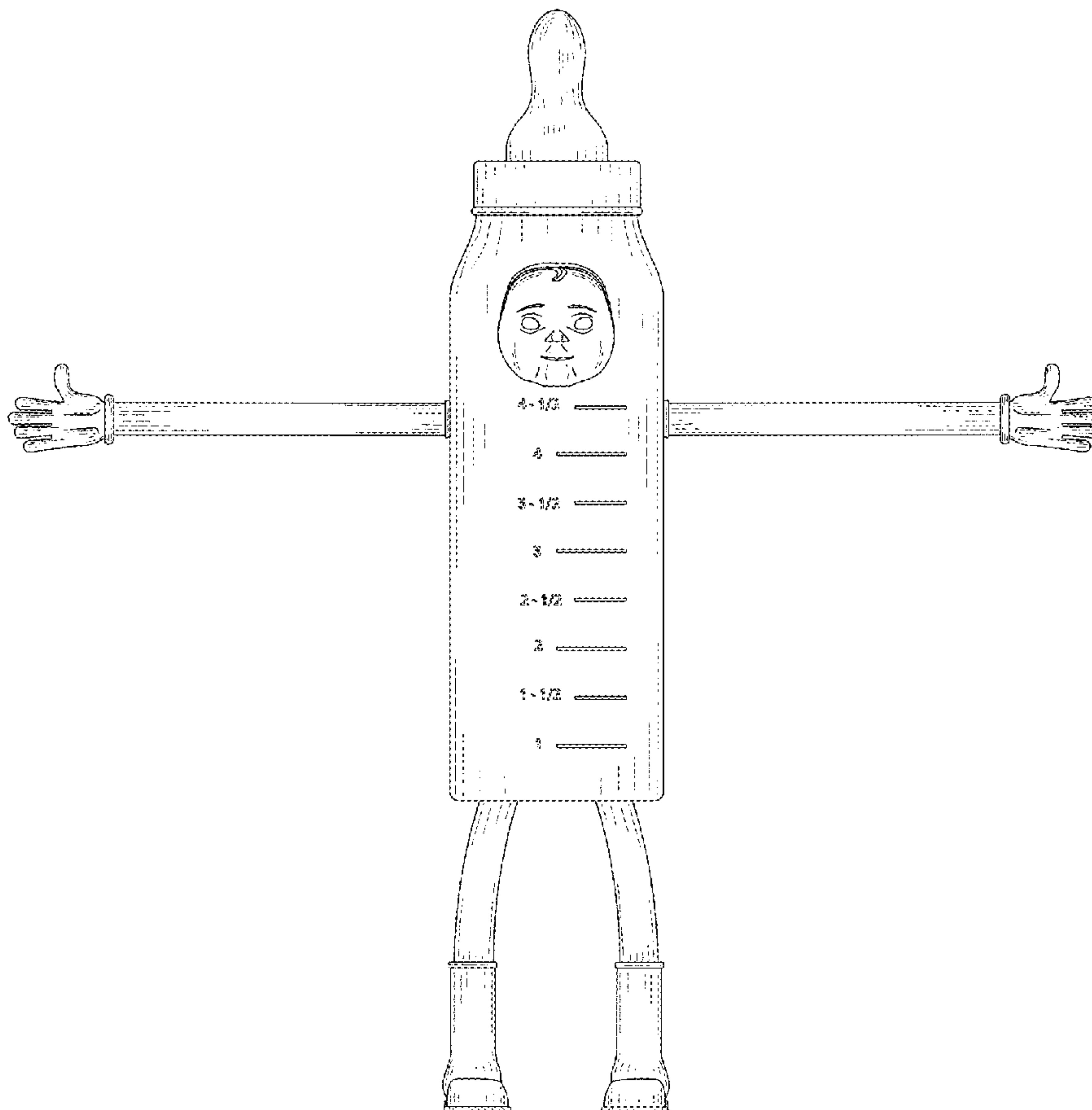

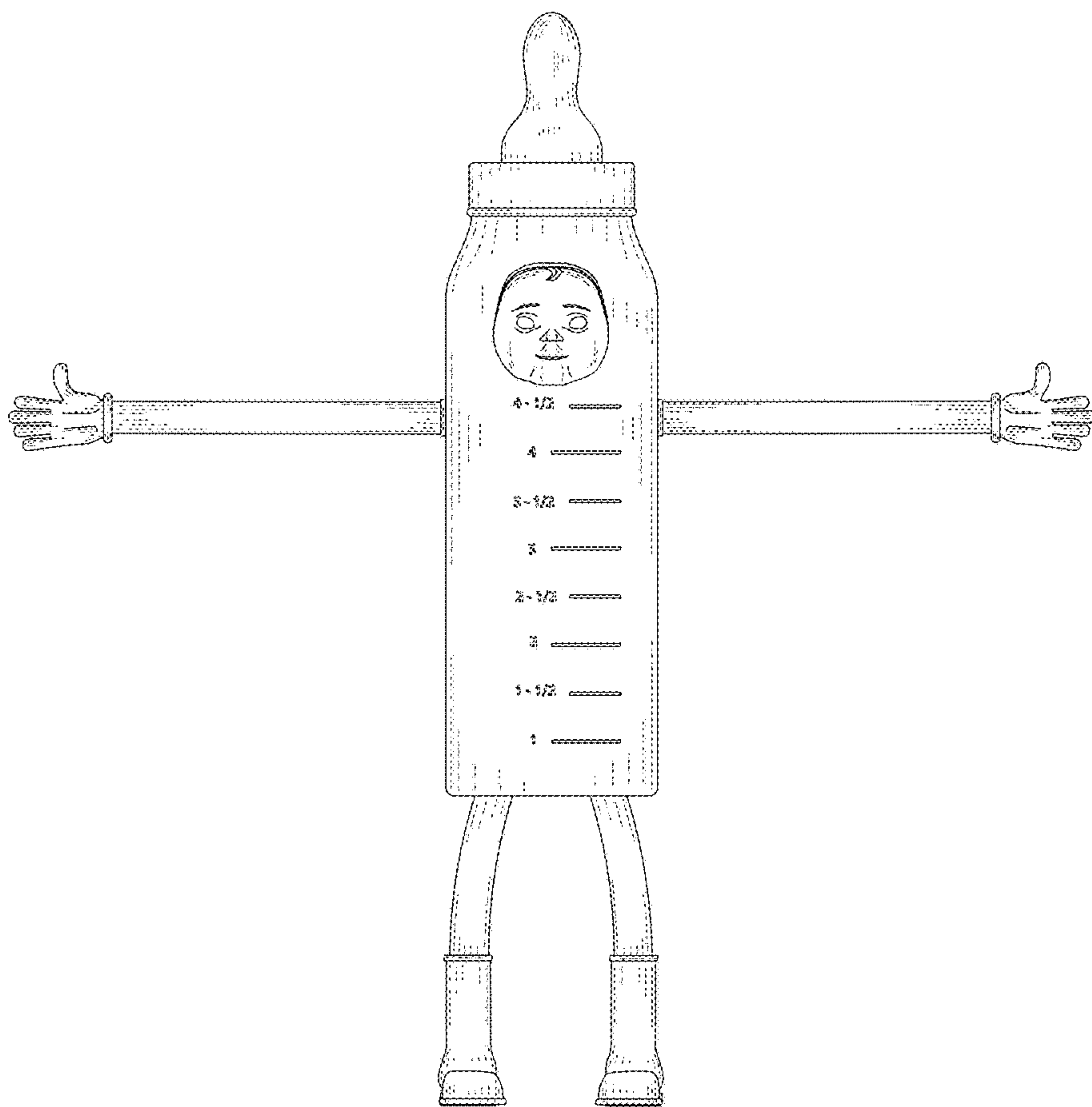

FIG. 1

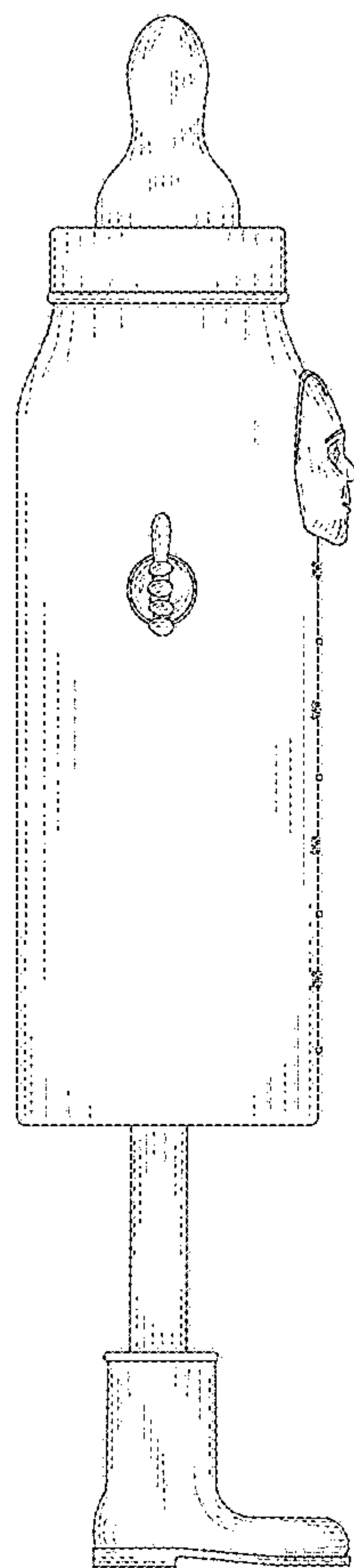

FIG. 2

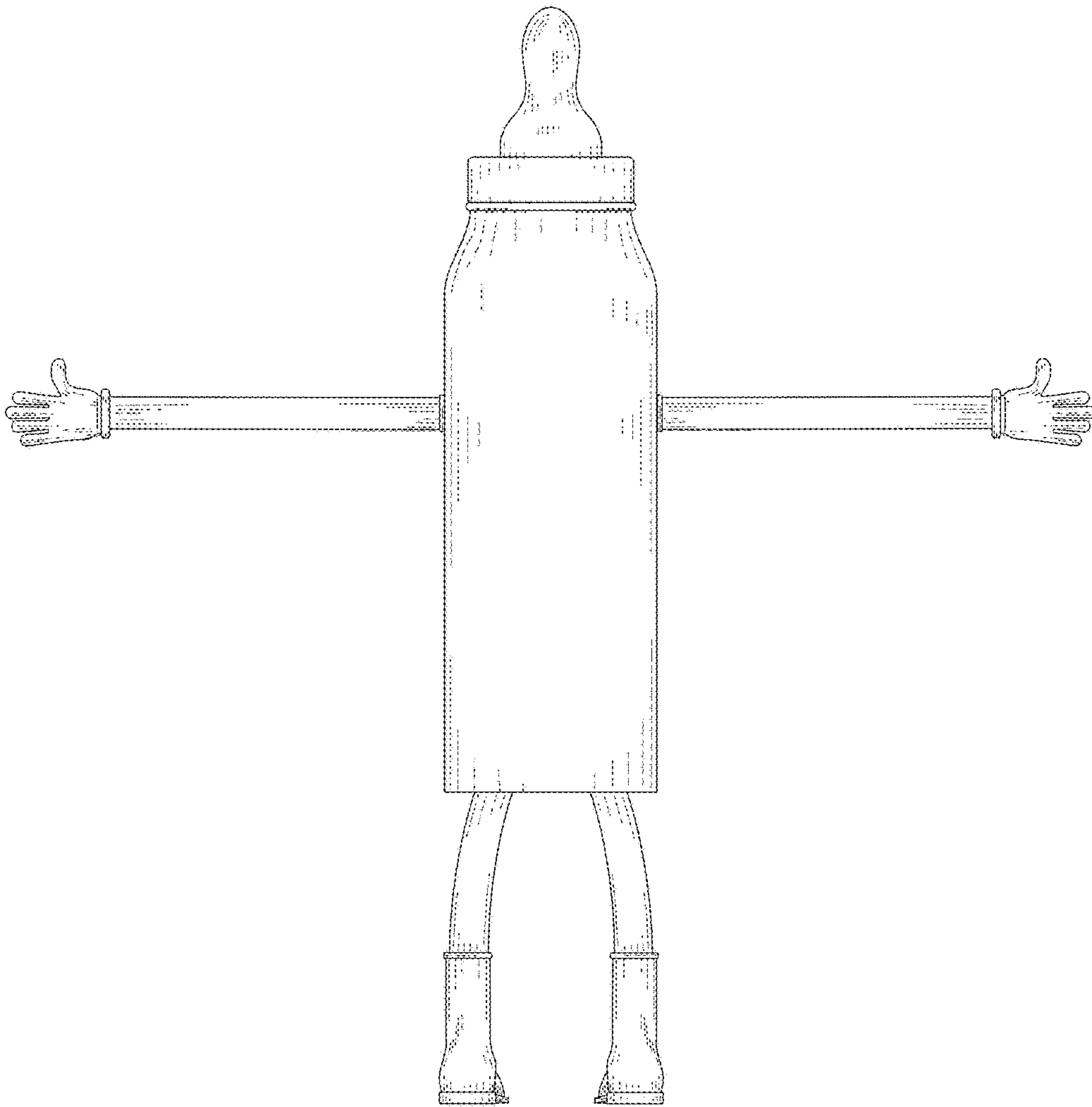

FIG. 3

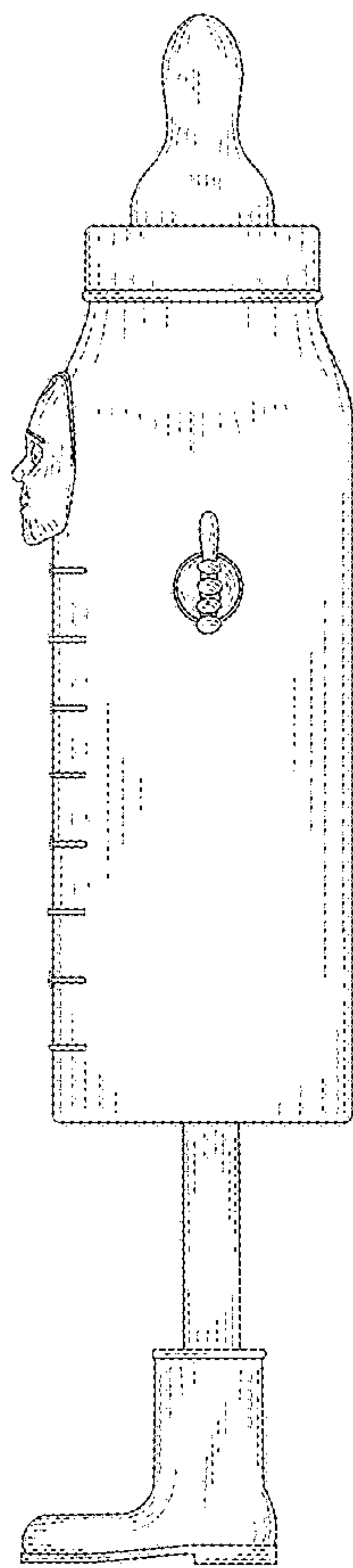

FIG. 4

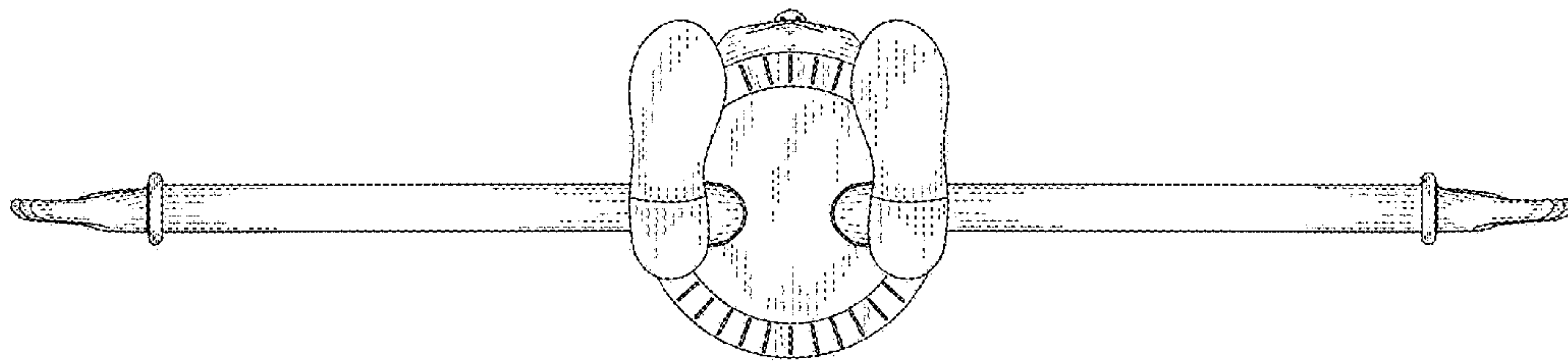

FIG. 5

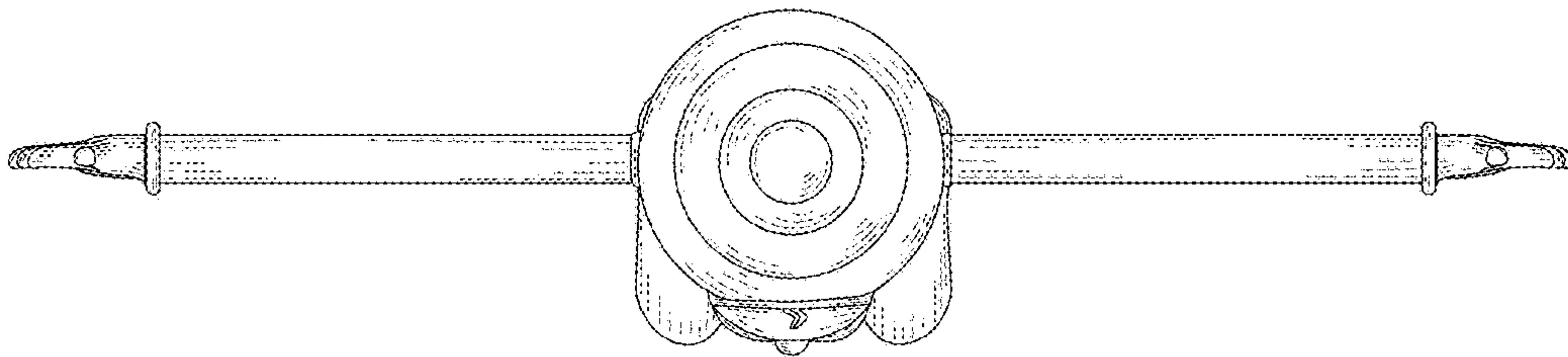

FIG. 6

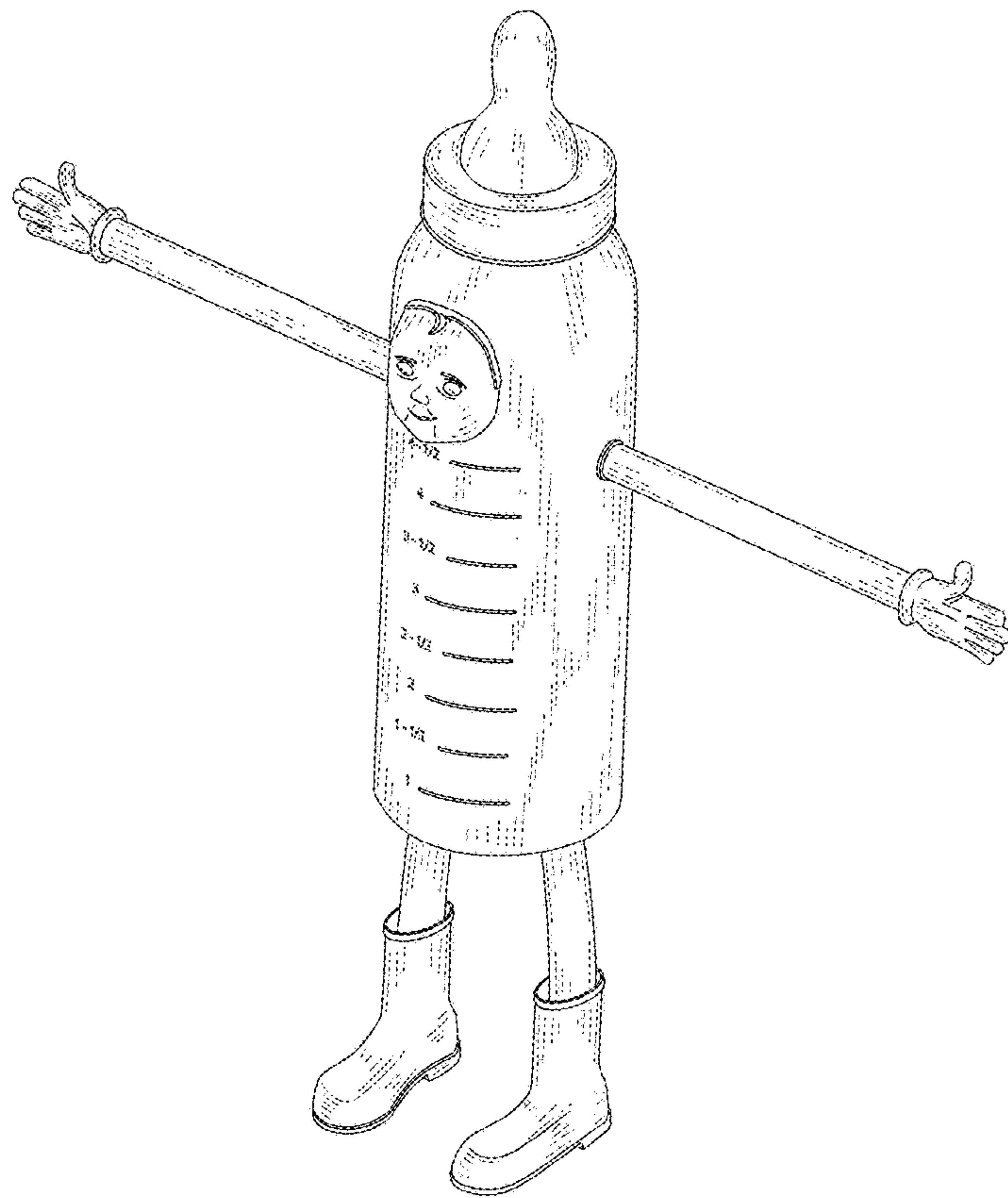

FIG. 7