

US00D862577S

(12) **United States Design Patent** (10) **Patent No.:** **US D862,577 S**
Lackner et al. (45) **Date of Patent:** **** Oct. 8, 2019**

(54) **RACK FOR ATTACHING SOUND EFFECT DEVICES**

(71) Applicant: **Hans-Peter Wilfer**, Markneukirchen (DE)

(72) Inventors: **Klaus Lackner**, Heidelberg (DE);
Roland Schmidt, Heidelberg (DE)

(73) Assignee: **Hans-Peter Wilfer**, Markneukirchen (DE)

(**) Term: **15 Years**

(21) Appl. No.: **29/632,407**

(22) Filed: **Jan. 8, 2018**

(30) **Foreign Application Priority Data**

Jul. 12, 2017 (DE) 40 2017 101 329

(51) **LOC (12) Cl.** **17-03**

(52) **U.S. Cl.**
USPC **D17/20**

(58) **Field of Classification Search**
USPC D14/217, 219, 229, 238.1, 260.1, 432,
D14/463, 299; D17/20, 21, 24, 99;
D7/678

CPC G10H 2220/071; G10H 2220/076; G10H
2220/165; G10H 2220/221; G10H
2220/30; G10H 2220/485; G10H 3/186;
G10H 2210/231; G10D 13/023; G10D
13/027; G10D 13/006

See application file for complete search history.

(56) **References Cited**

U.S. PATENT DOCUMENTS

D242,766 S * 12/1976 Neece D8/354
4,332,482 A * 6/1982 Engler B01F 13/002
366/130
D344,644 S * 3/1994 Long D6/407
D358,524 S * 5/1995 Sedon D6/629

5,669,499 A * 9/1997 Chen G11B 23/023
206/387.1
D397,692 S * 9/1998 Mackie D14/217
D408,820 S * 4/1999 Ito D14/217

(Continued)

FOREIGN PATENT DOCUMENTS

FR 2698475 A1 * 5/1994 B65D 25/107
JP 2002028016 A * 1/2002 H05K 5/0086
JP 2013181381 A * 9/2013

OTHER PUBLICATIONS

Unbiased Gear Review—Rockboard by Warwick Tres 3.1 Pedalboard and accessories, posted Sep. 1, 2018 02:11 [online], retrieved Jan. 2, 2019, retrieved from internet, <<https://www.youtube.com/watch?v=p3jnm-c1Q48&feature=youtu.be>>.*

(Continued)

Primary Examiner — Barbara Fox
Assistant Examiner — Messina L Smith

(74) *Attorney, Agent, or Firm* — Scarinci Hollenbeck, LLC; Libby Babu Varghese

(57) **CLAIM**

The ornamental design for a rack for attaching sound effect devices, as shown.

DESCRIPTION

FIG. 1 is a perspective view of a rack for attaching sound effect devices, showing the new design.

FIG. 2 is a bottom view thereof;

FIG. 3 is a back view thereof;

FIG. 4 is a front view thereof;

FIG. 5 is a left-side view thereof;

FIG. 6 is a right-side view thereof; and,

FIG. 7 is a top view thereof.

The broken lines in the drawings depict portions of the rack for attaching sound effect devices that form no part of the claimed design.

1 Claim, 7 Drawing Sheets

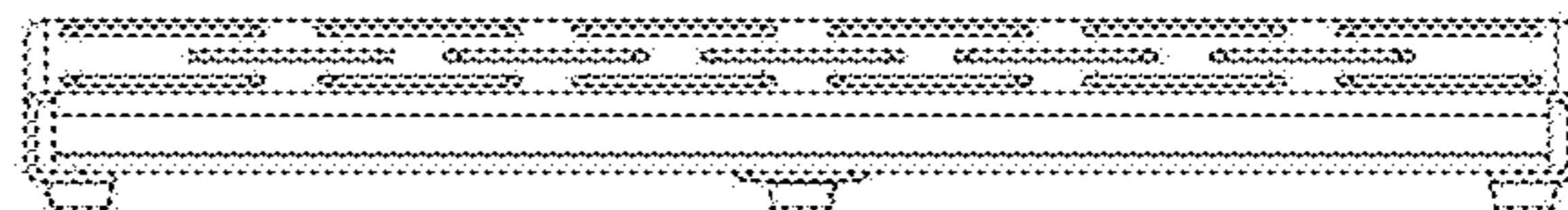
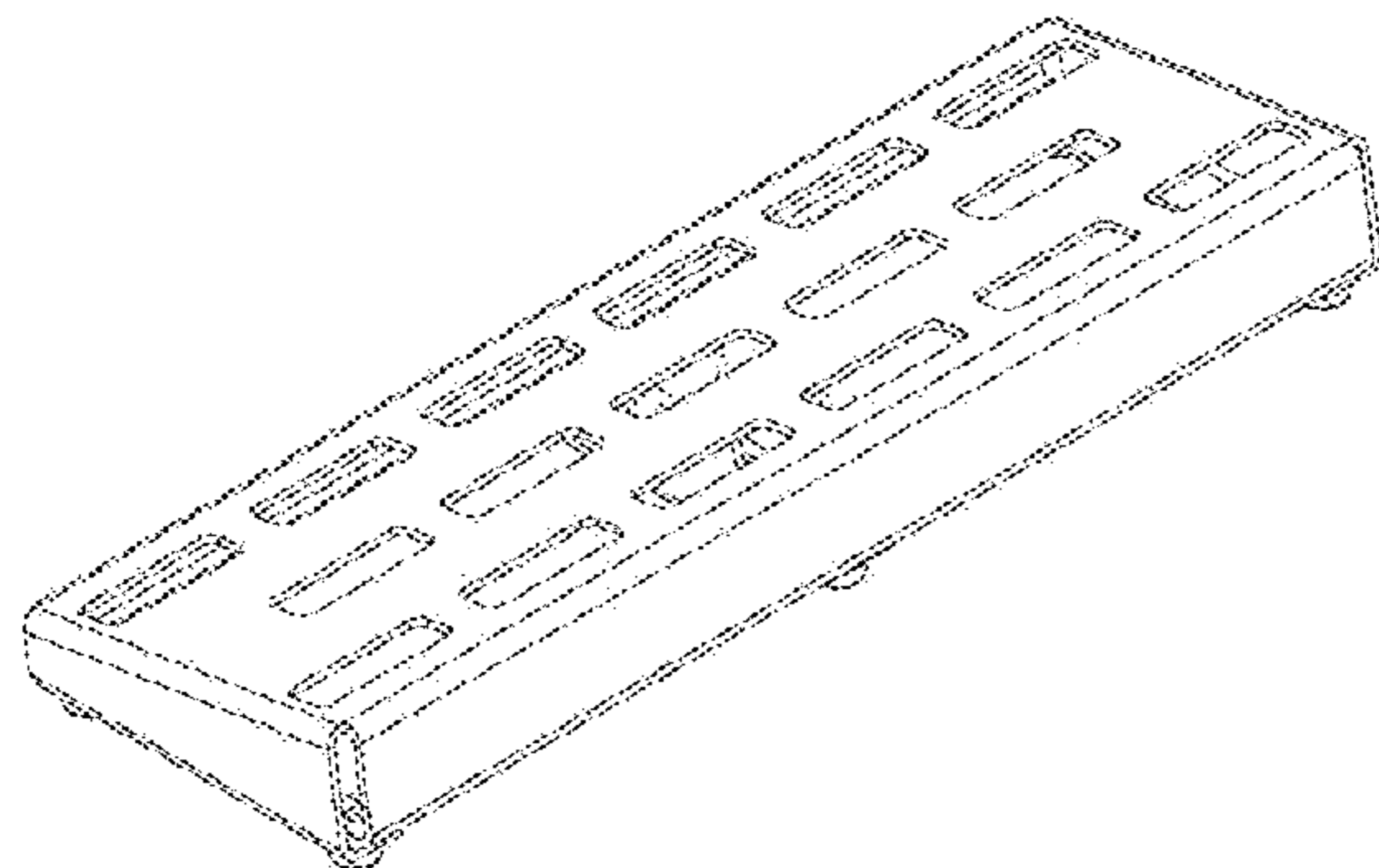

(56)

References Cited

U.S. PATENT DOCUMENTS

D423,479 S * 4/2000 Alo D14/260.1
 D426,231 S * 6/2000 Mackie D14/217
 D439,603 S * 3/2001 Laird D17/99
 D490,800 S * 6/2004 Kitazawa D14/217
 D491,554 S * 6/2004 Amiya D14/217
 D563,385 S * 3/2008 Skurdal D14/214
 D563,392 S * 3/2008 Corsini D14/217
 D630,617 S * 1/2011 Ayres D14/217
 D643,410 S * 8/2011 Blyth D14/217
 D652,693 S * 1/2012 De Buyer D7/412
 D662,914 S * 7/2012 Constin D14/217
 D721,353 S * 1/2015 Money D14/217
 D763,827 S * 8/2016 McMillen D14/217
 D780,161 S * 2/2017 Kimura D14/217
 D781,954 S * 3/2017 Wilfer D17/20
 D792,503 S * 7/2017 Helweg D17/20
 D807,329 S * 1/2018 Kim D14/217
 D809,484 S * 2/2018 Shi D14/217
 D819,120 S * 5/2018 Wilfer D17/20
 D819,726 S * 6/2018 Belitz D17/20
 D820,904 S * 6/2018 Fiden D17/99
 D823,377 S * 7/2018 Kitamura D17/99
 D824,367 S * 7/2018 Tschetter D14/217

D824,424 S * 7/2018 Petty D14/496
 D827,611 S * 9/2018 Kuramoto D14/217
 D832,333 S * 10/2018 Kushner D17/20
 D832,334 S * 10/2018 Kushner D17/20
 2006/0109760 A1 * 5/2006 Seelig G11B 25/10
 369/47.12
 2006/0243680 A1 * 11/2006 Levesque H05K 7/1425
 211/26
 2011/0303077 A1 * 12/2011 Vinciguerra G10H 1/0091
 84/746
 2013/0201398 A1 * 8/2013 Radin H03G 5/005
 348/552
 2017/0140744 A1 * 5/2017 Kreifeldt G10H 1/348
 2017/0243572 A1 * 8/2017 Trifilio G10D 1/085

OTHER PUBLICATIONS

Trying to build the ultimate PEDALBOARD!, posted Jul. 21, 2018
 01:08 [online], retrieved Jan. 2, 2019, retrieved from internet,
 <<https://www.youtube.com/watch?v=ctpP6zIX4Ow>>.*
 Pedalboard Sets, no posting date given [online], retrieved Jan. 2,
 2019, retrieved from internet, <<https://shop.warwick.de/en/RockBoard+by+Warwick/Pedalboard+Sets/RockBoard+DUO+2.1+with+Flight+Case>>.*

* cited by examiner

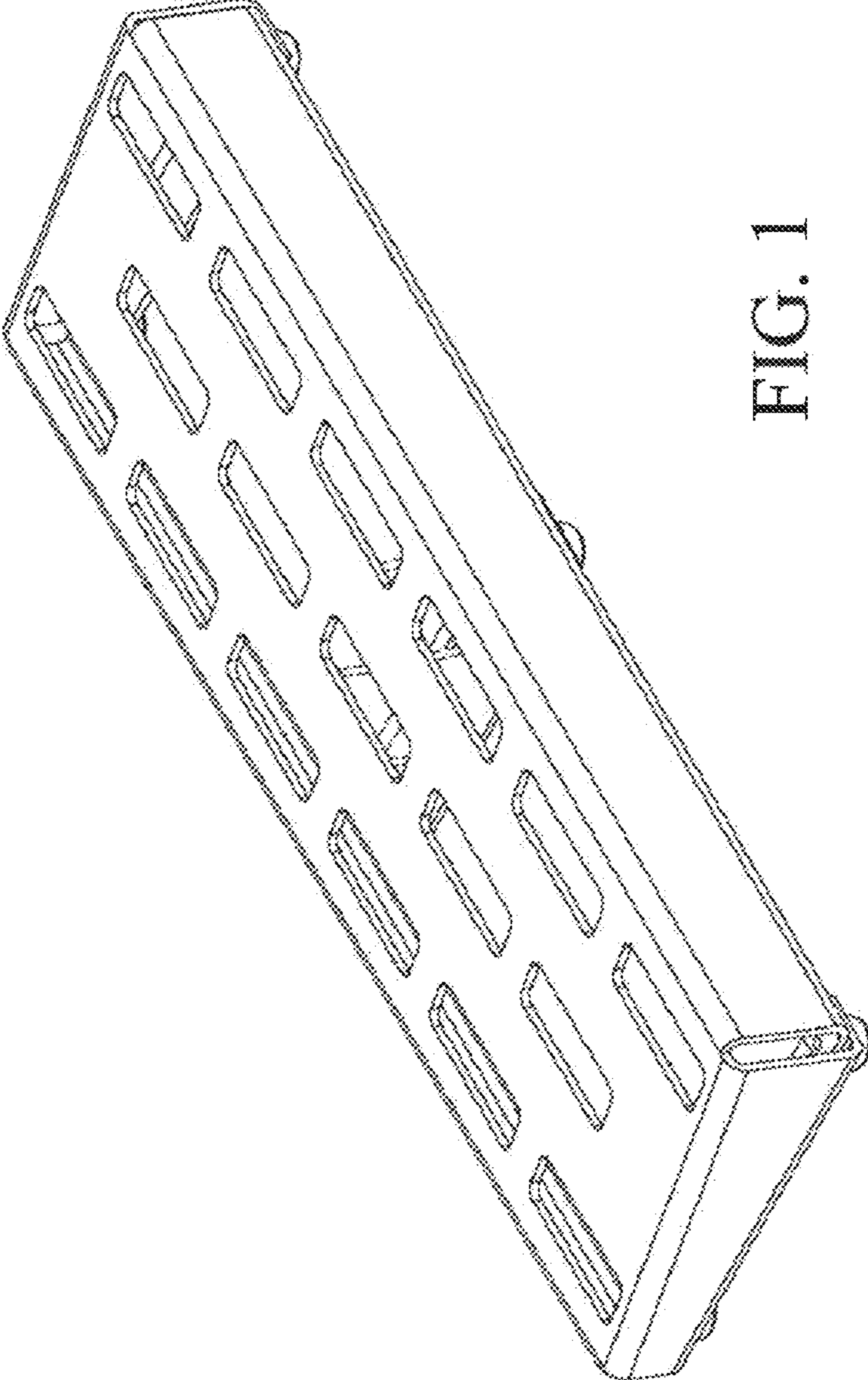

FIG. 1

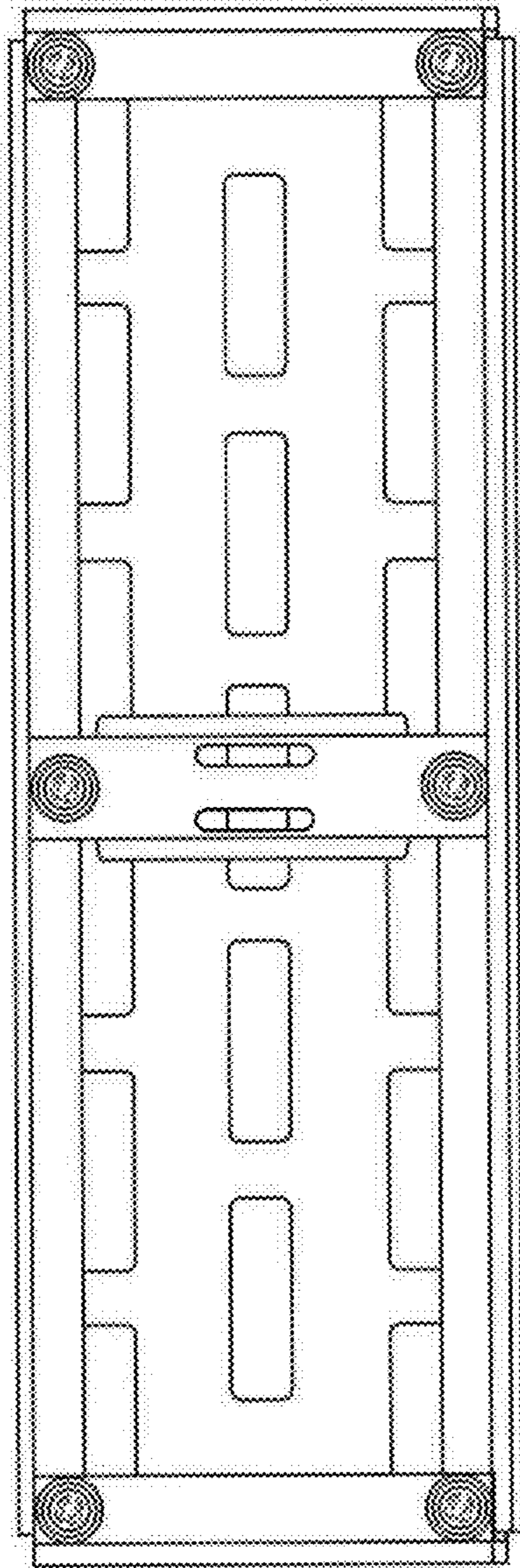

FIG. 2



FIG. 3

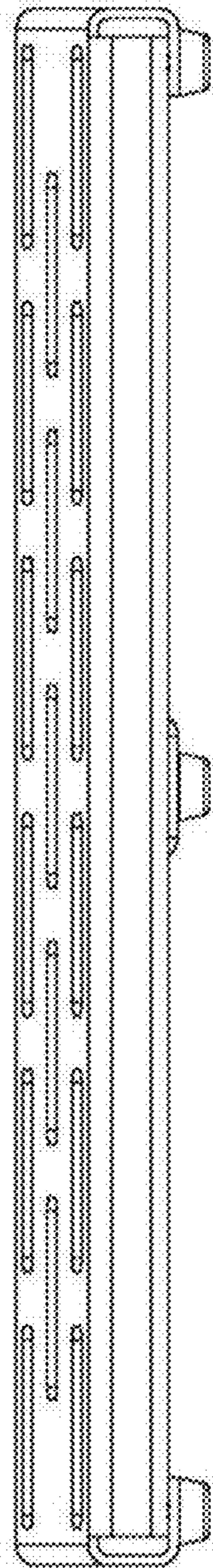

FIG. 4

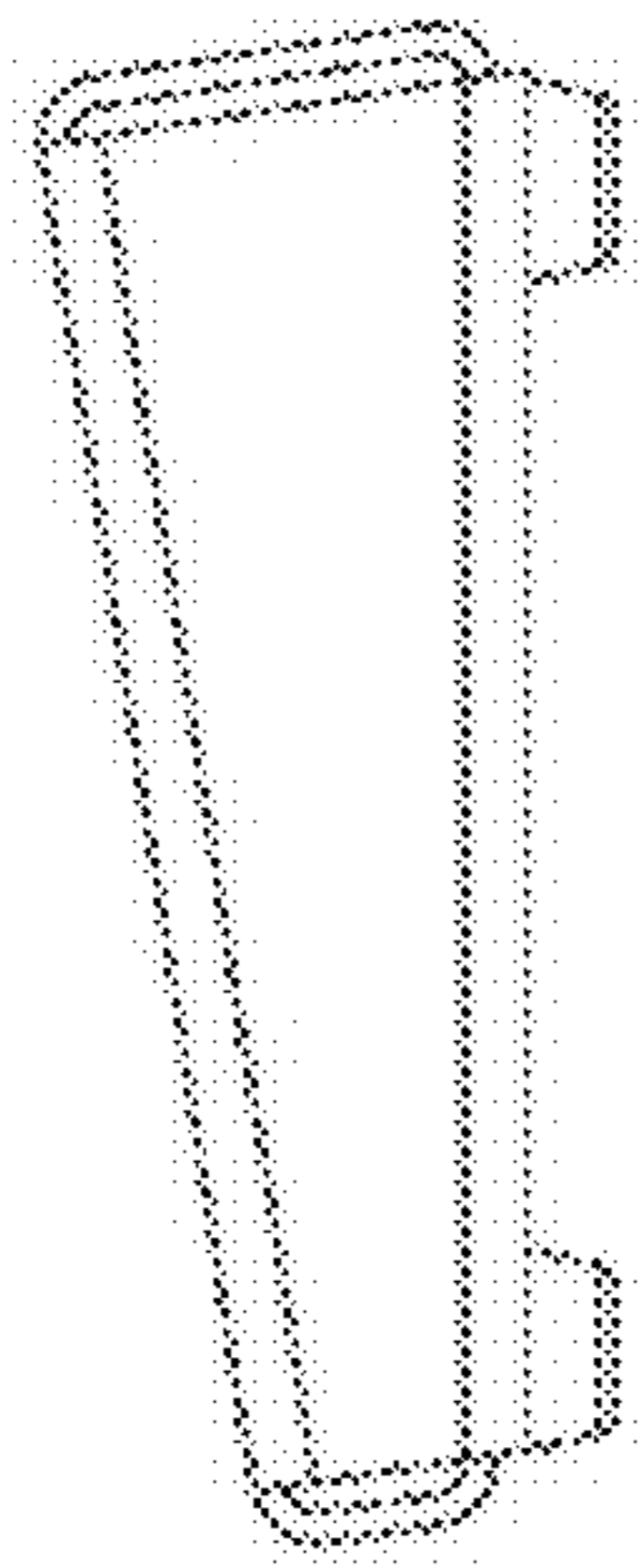

FIG. 5

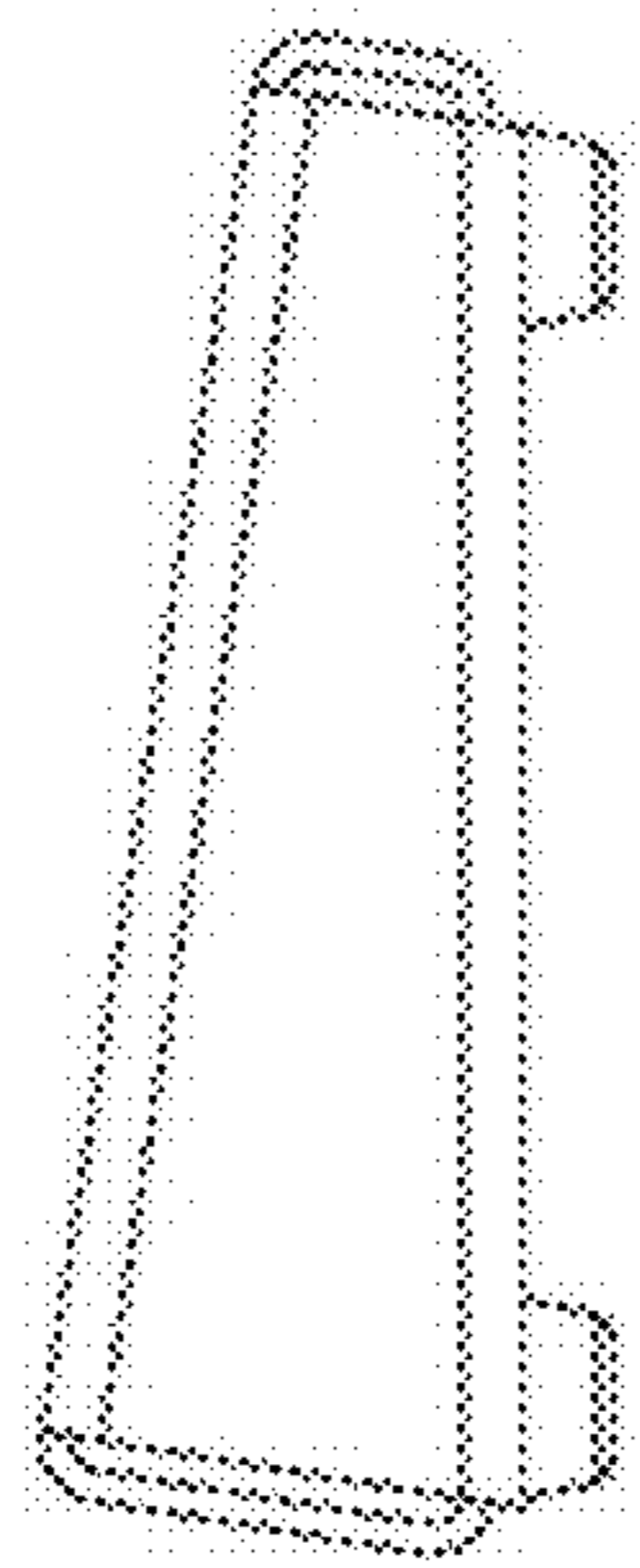

FIG. 6

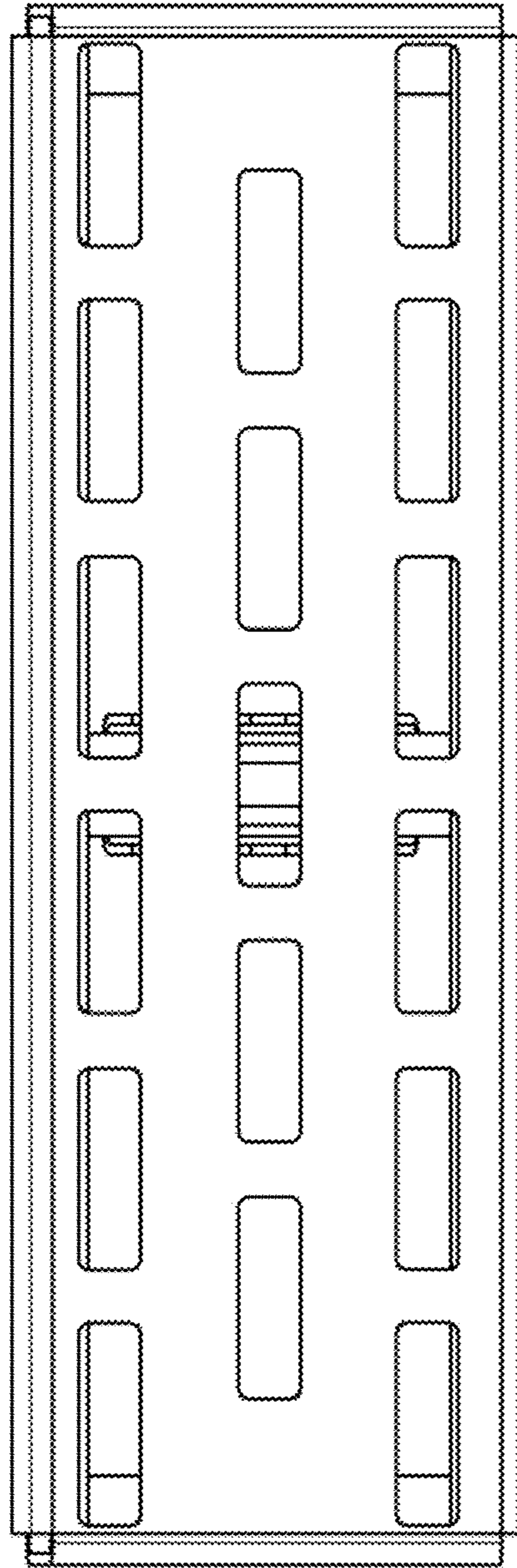

FIG. 7