



US00D862483S

(12) **United States Design Patent** (10) **Patent No.:** **US D862,483 S**
Shim (45) **Date of Patent:** **** Oct. 8, 2019**

(54) **USB DRIVE**
(71) Applicant: **SAMSUNG ELECTRONICS CO., LTD.**, Suwon-si (KR)
(72) Inventor: **Hyung Sup Shim**, Seoul (KR)
(73) Assignee: **SAMSUNG ELECTRONICS CO., LTD.**, Suwon-si (KR)

D773,476 S 12/2016 Shim
D783,629 S * 4/2017 Shim D14/480.1
D785,001 S 4/2017 Shim
D786,263 S 5/2017 Shim
D831,669 S * 10/2018 Shim D14/480.5
D831,670 S * 10/2018 Shim D14/480.5
D836,647 S * 12/2018 Wei D14/480.7
D841,010 S * 2/2019 Kong D14/435.1
D842,308 S * 3/2019 Shim D14/480.5

(**) Term: **15 Years**
(21) Appl. No.: **29/653,452**
(22) Filed: **Jun. 15, 2018**

FOREIGN PATENT DOCUMENTS

KR 30-0803272 S 6/2015
KR 30-0837846 S 2/2016
KR 30-0837849 S 2/2016

* cited by examiner

(30) **Foreign Application Priority Data**

Dec. 29, 2017 (KR) 30-2017-0062605

(51) **LOC (12) Cl.** **14-03**
(52) **U.S. Cl.**
USPC **D14/480.1**

(58) **Field of Classification Search**
USPC D14/480.1-480.7, 435.1, 411, 433, 436,
D14/484.1, 137, 155, 203.1-203.8, 240,
D14/242; D13/133, 154
CPC H05K 5/0278; G06K 19/07732
See application file for complete search history.

(56) **References Cited**

U.S. PATENT DOCUMENTS

D511,519 S * 11/2005 Bone D14/480.1
D631,053 S * 1/2011 Bailey D10/70
D759,028 S * 6/2016 Emami D14/480.1
D769,882 S * 10/2016 Hair D14/480.1
D771,636 S * 11/2016 Shim D14/480.1

Primary Examiner — Angela J Lee

(74) *Attorney, Agent, or Firm* — Sughrue Mion, PLLC

(57) **CLAIM**

The ornamental design for a USB drive, as shown and described.

DESCRIPTION

FIG. 1 is a perspective view showing the whole shape of this design.

FIG. 2 is a front view thereof.

FIG. 3 is a rear view thereof.

FIG. 4 is a left side view thereof.

FIG. 5 is a right side view thereof.

FIG. 6 is a top plan view thereof.

FIG. 7 is a bottom plan view thereof; and,

FIG. 8 is a perspective view showing the use thereof.

The features in broken lines show environment only and form no part of the claimed design.

1 Claim, 6 Drawing Sheets

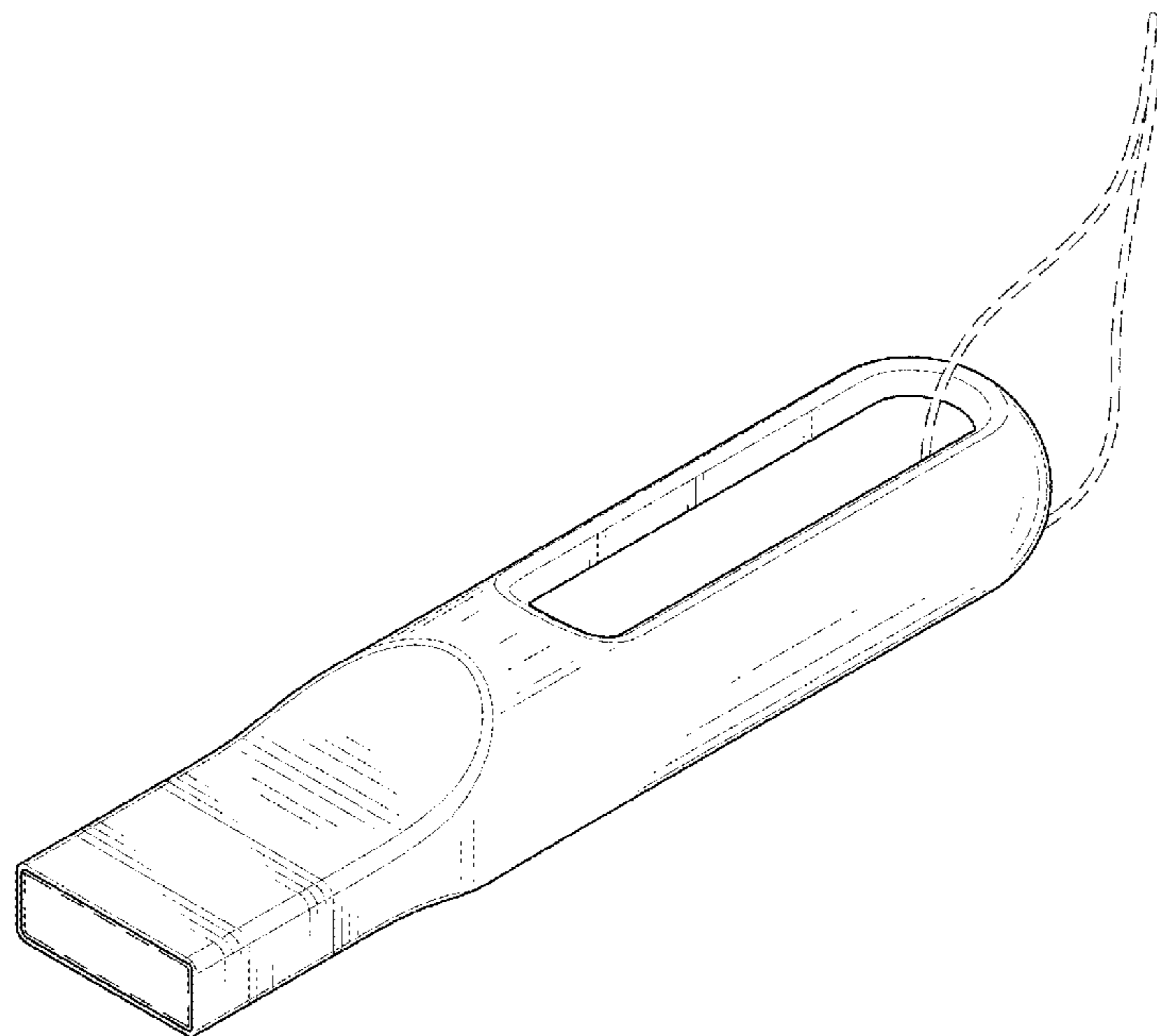

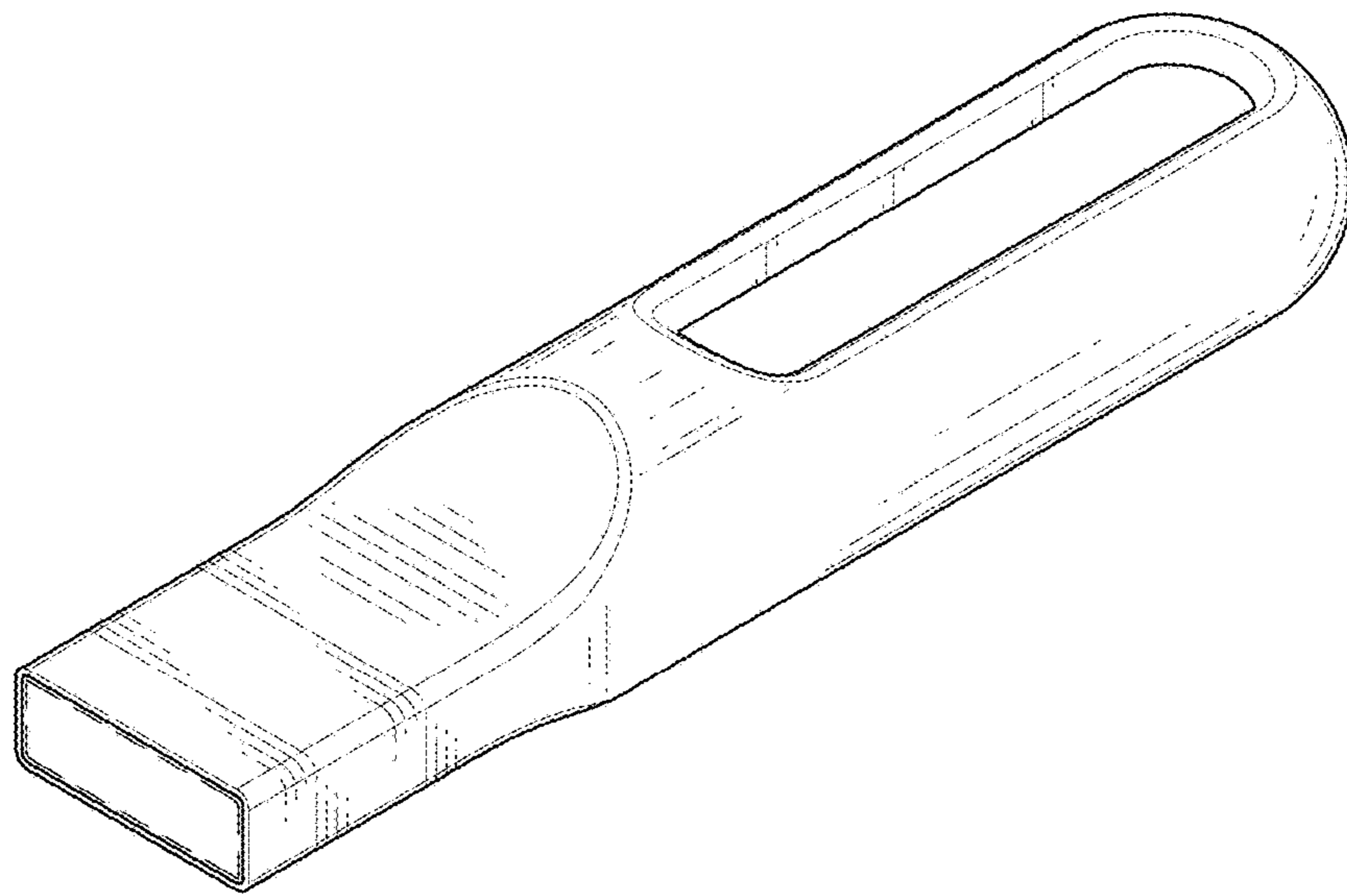

FIG. 1

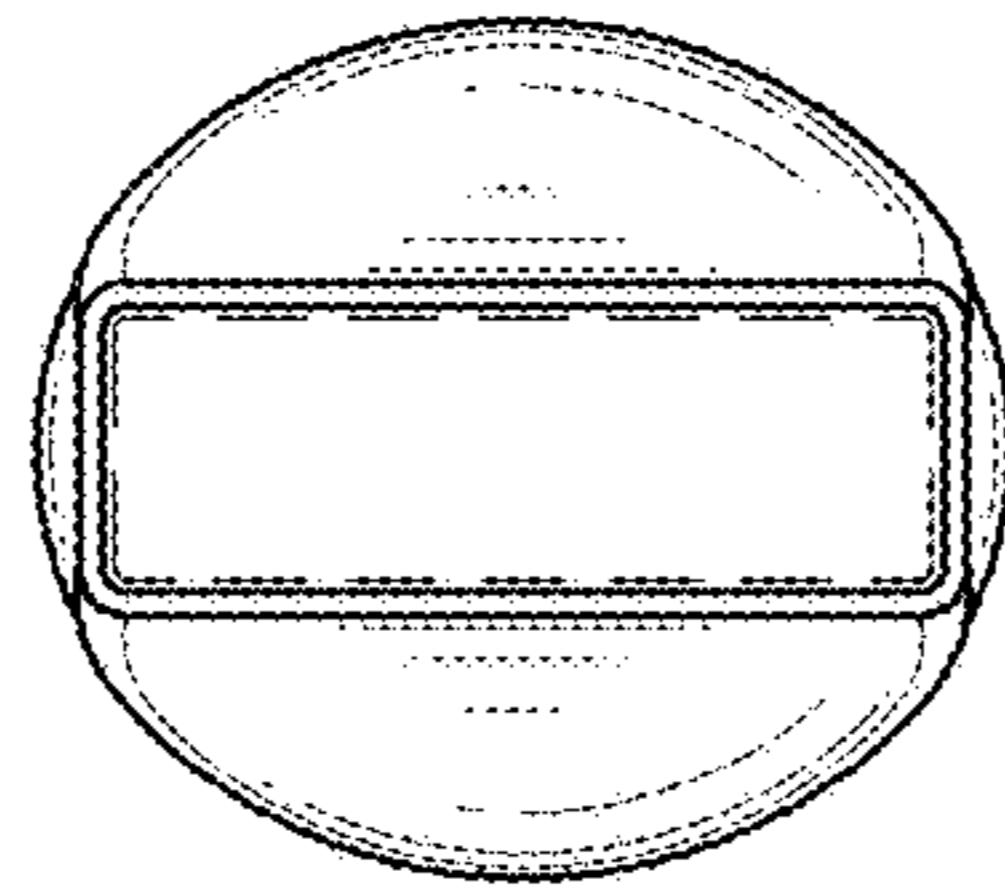

FIG. 2

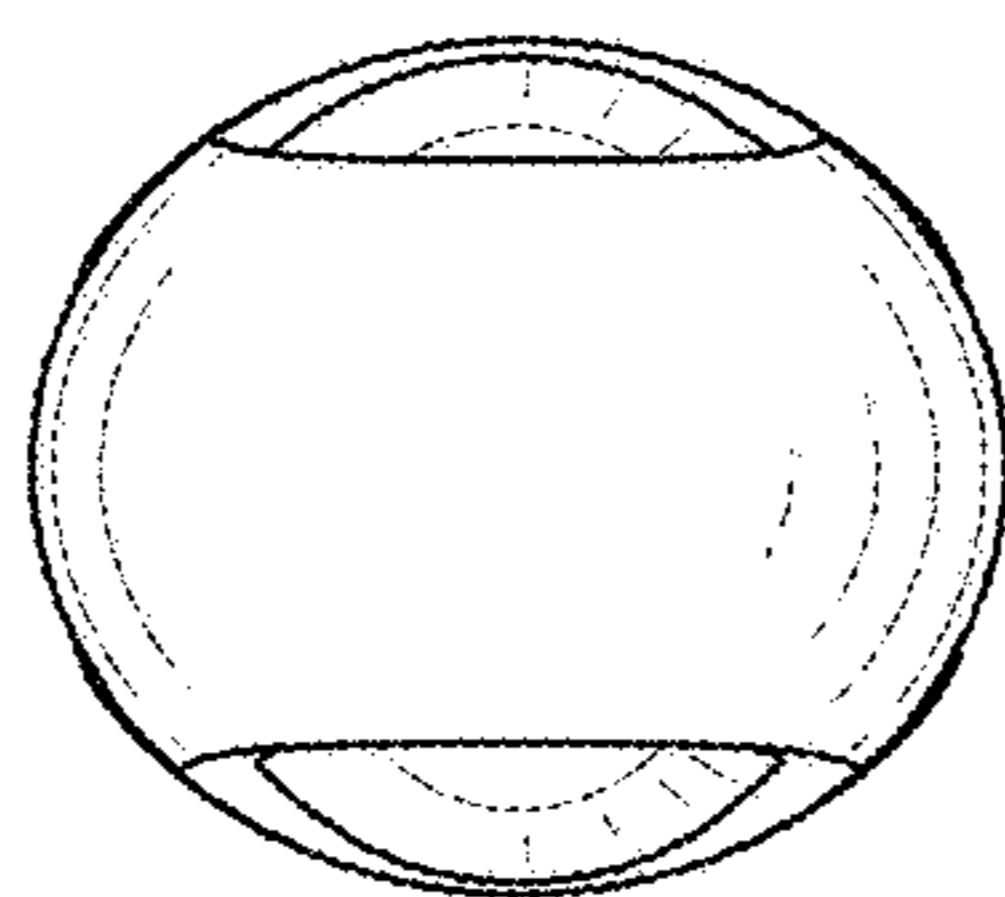

FIG. 3

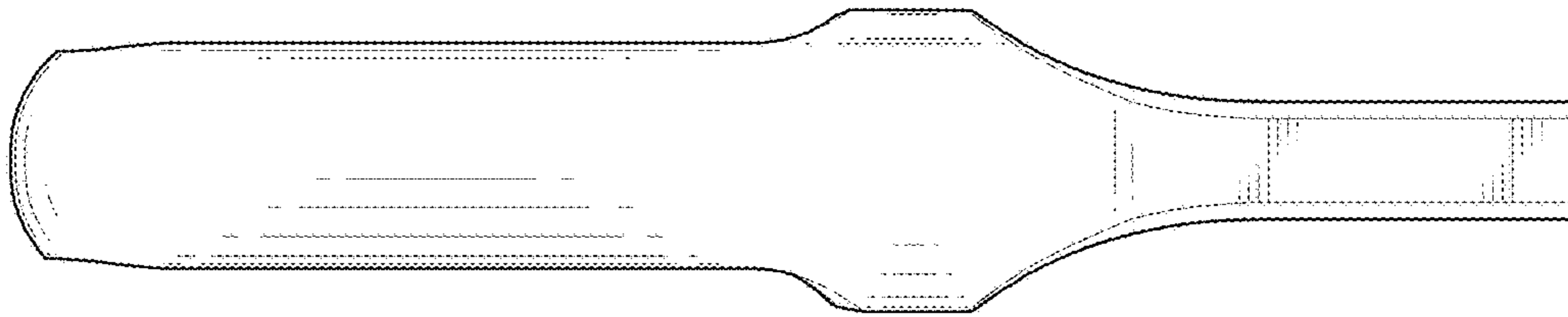

FIG. 4

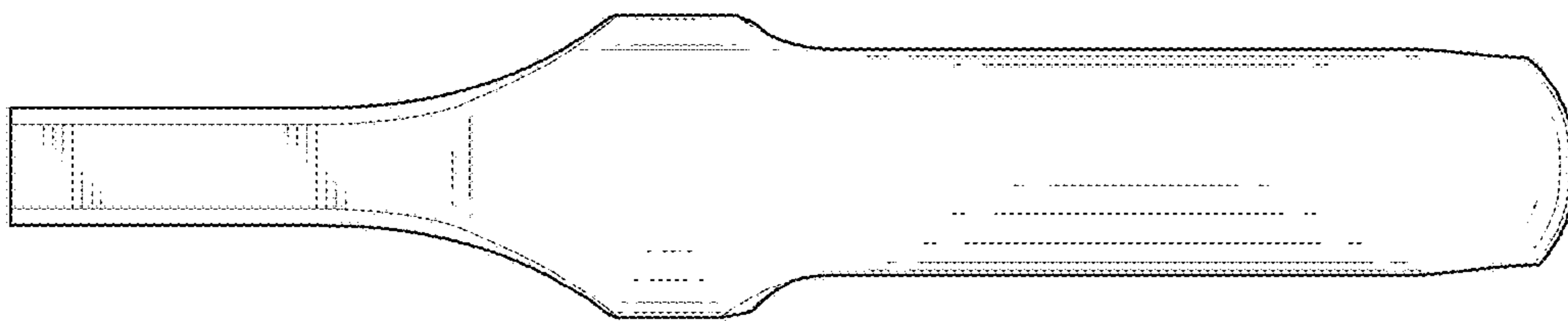

FIG. 5

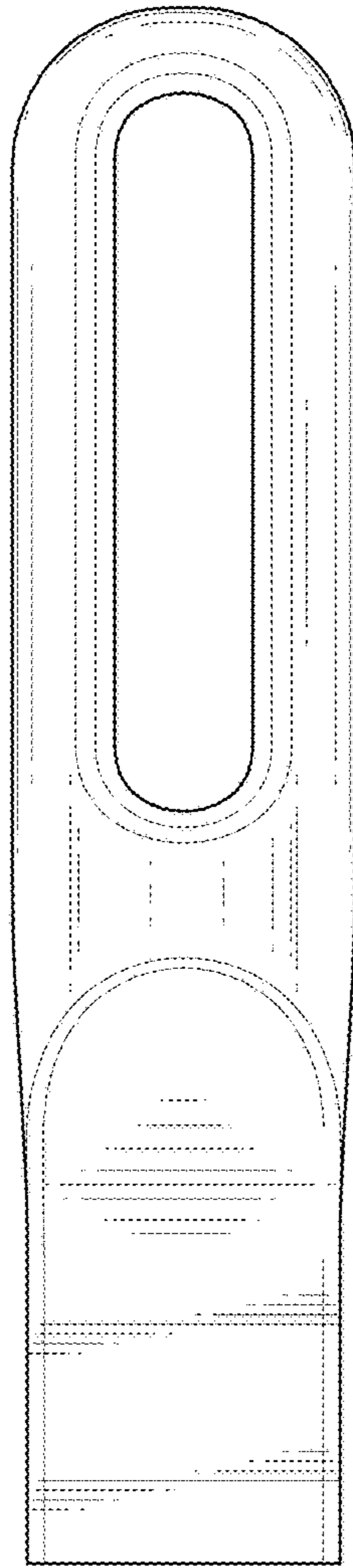

FIG. 6

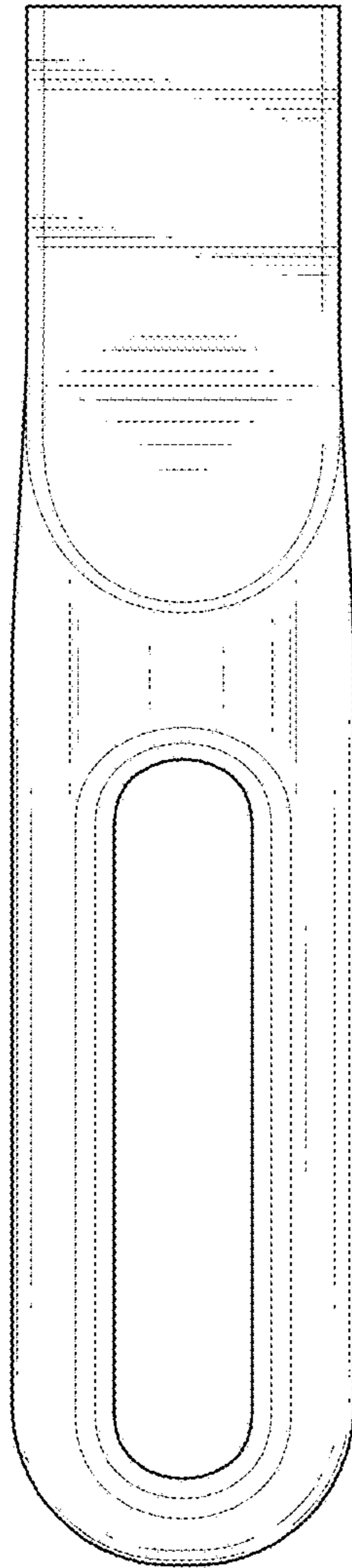

FIG. 7

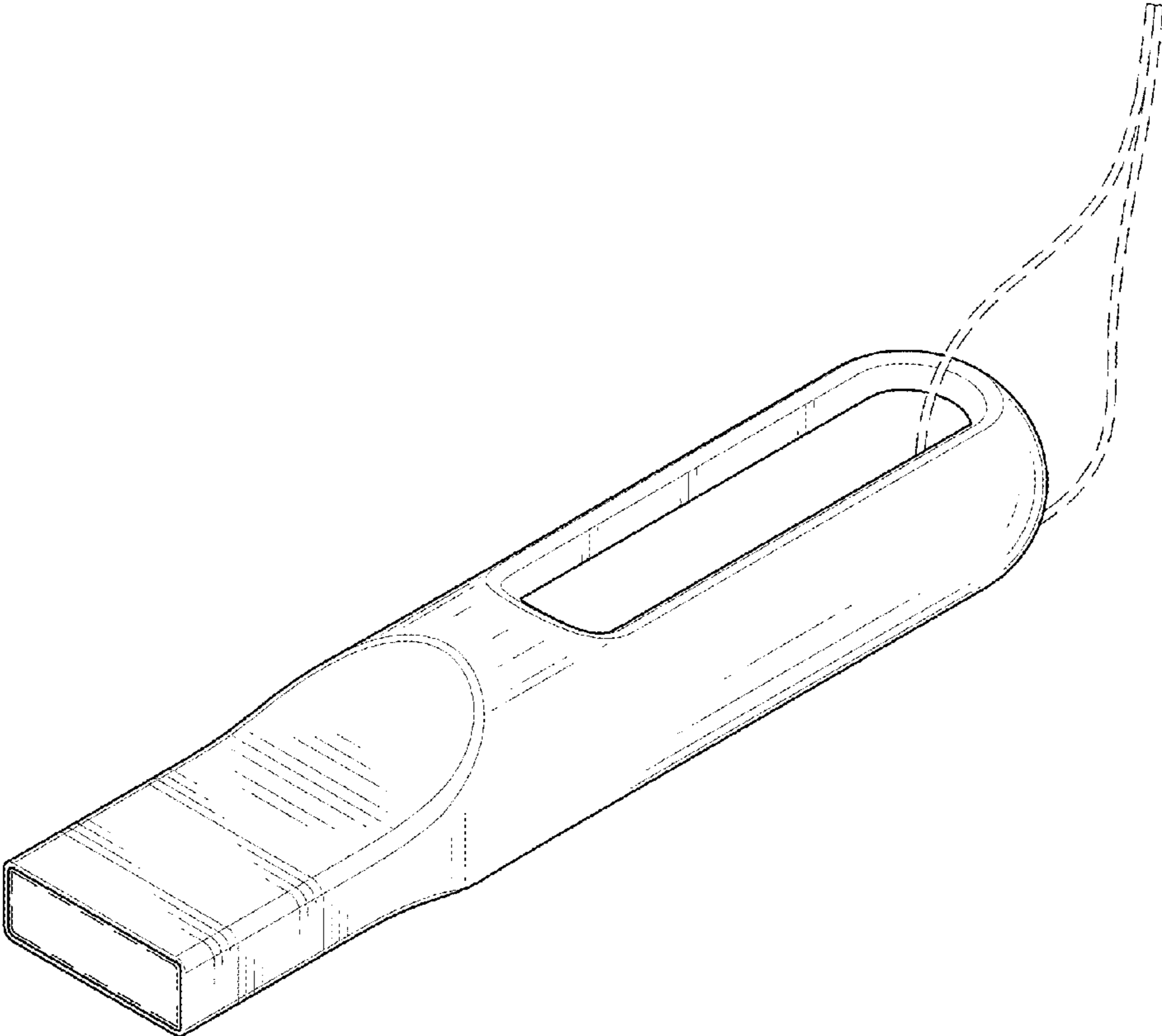

FIG. 8