

US00D862479S

(12) **United States Design Patent** (10) **Patent No.:** **US D862,479 S**
Ahn (45) **Date of Patent:** **** Oct. 8, 2019**

(54) **CASE FOR TABLET COMPUTER**
(71) Applicant: **SPIGEN KOREA CO., LTD.**, Seoul (KR)
(72) Inventor: **Deok Hyun Ahn**, Seoul (KR)
(73) Assignee: **SPIGEN KOREA CO., LTD.**, Seoul (KR)

D703,664 S 4/2014 Spiro et al.
D703,672 S 4/2014 Kim et al.
D709,510 S 7/2014 Soare
D712,412 S 9/2014 Bleau et al.
D727,917 S * 4/2015 Yeo D14/440
D727,918 S 4/2015 Soare
(Continued)

(**) Term: **15 Years**
(21) Appl. No.: **29/658,659**
(22) Filed: **Aug. 1, 2018**

Related U.S. Application Data

(63) Continuation of application No. 29/647,287, filed on May 11, 2018.
(51) **LOC (12) Cl.** **14-02**
(52) **U.S. Cl.**
USPC **D14/440**
(58) **Field of Classification Search**
USPC D14/440, 250, 447; 206/45.23, 320, 206/45.2; 361/679.55; 294/25; 224/218
CPC ... G06F 1/1628; G06F 1/1626; A47B 23/044; H04B 1/3888
See application file for complete search history.

References Cited

U.S. PATENT DOCUMENTS

D492,303 S 6/2004 Schlieffers et al.
D493,787 S 8/2004 Avery
D532,822 S 11/2006 White et al.
D537,883 S 3/2007 Gunter et al.
D591,801 S 5/2009 Mak
D689,056 S * 9/2013 Li D14/440
D690,704 S * 10/2013 Padilla D14/440
D691,144 S 10/2013 Peters et al.
D691,146 S 10/2013 Perez
D694,246 S 11/2013 Park et al.
D696,257 S 12/2013 Ward et al.

OTHER PUBLICATIONS

“HDE Case for iPad 9.7-inch 2018 / 2017 Kids Shockproof Bumper Hard Cover Handle Stand with Built in Screen Protector for New Apple Education iPad 9.7 Inch (6th Gen) / 5th Generation iPad 9.7—Blue”, <https://www.amazon.com/dp/B072Y1SS5L>, earliest review date of Jul. 19, 2017.

(Continued)

Primary Examiner — Cynthia R Underwood
(74) *Attorney, Agent, or Firm* — Heedong Chae; Lucem, PC

(57) **CLAIM**

The ornamental design for a case for tablet computer, as shown and described.

DESCRIPTION

FIG. 1 is a front perspective view of a case for tablet computer showing my new design; FIG. 2 is a rear perspective view thereof; FIG. 3 is a front elevational view thereof; FIG. 4 is a rear elevational view thereof; FIG. 5 is a left side elevational view thereof; FIG. 6 is a right side elevational view thereof; FIG. 7 is a top plan view thereof; and, FIG. 8 is a bottom plan view thereof. The broken lines throughout the drawing figures depict portions of the case that form no part of the claimed design. The broken lines and regions bounded by broken lines form no part of the claimed design.

1 Claim, 8 Drawing Sheets

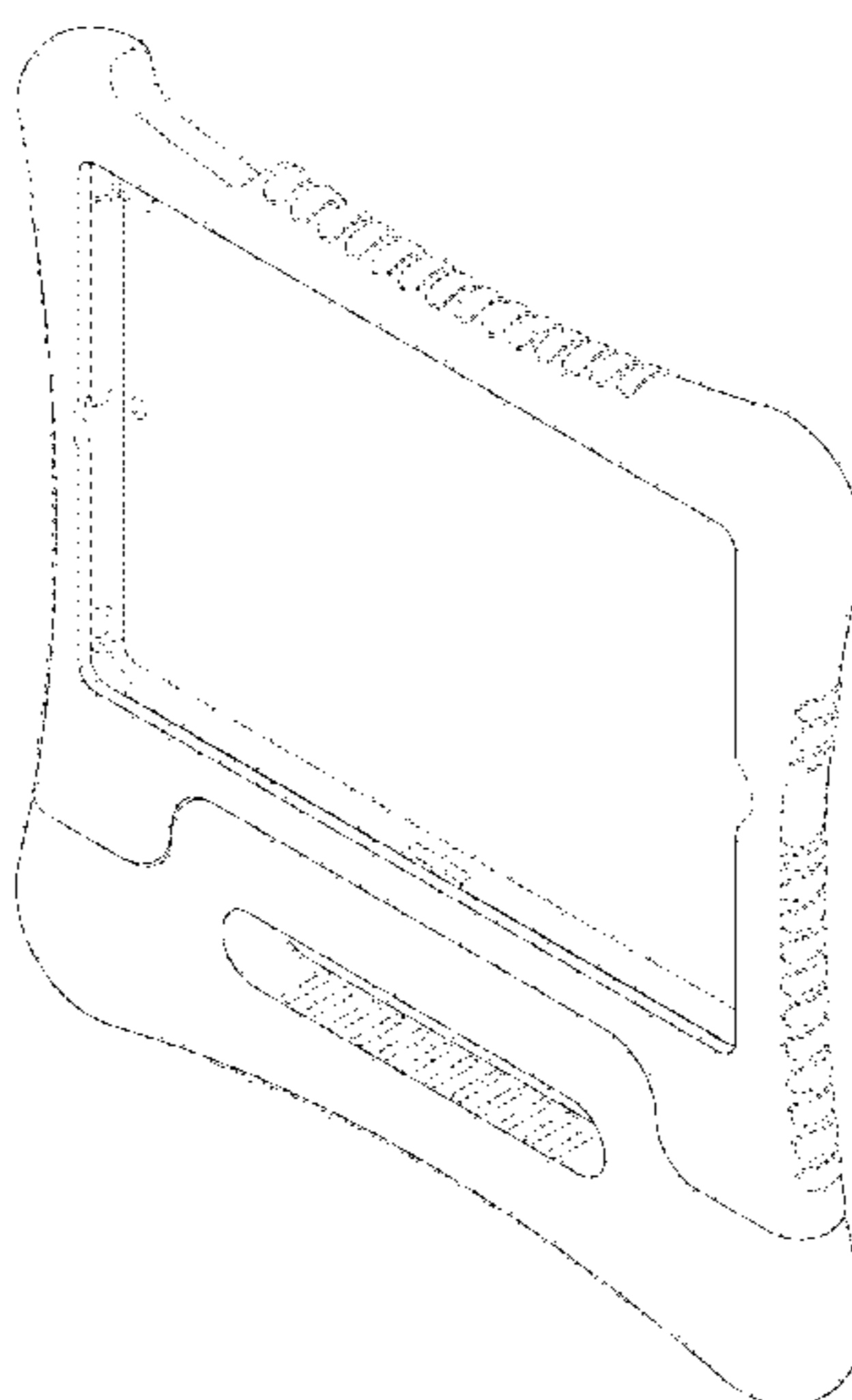

(56)

References Cited

U.S. PATENT DOCUMENTS

D749,592 S	2/2016	Huang	
D778,903 S	2/2017	Tsai	
D784,350 S	4/2017	Li	
D791,773 S	7/2017	Moore et al.	
D807,366 S *	1/2018	Chen	D14/440
D829,720 S	10/2018	Zhang	
D834,581 S *	11/2018	Li	D14/440
D835,625 S *	12/2018	Li	D14/440

OTHER PUBLICATIONS

“Fintie Case for Apple iPad 9.7 Inch 2018 (6th Gen)/iPad 9.7" 2017 (5th Gen)/iPad Air 2/iPad Air—Kiddie Series Light Weight Shock Proof Convertible Handle Stand Cover Kids Friendly—Blue”, <https://www.amazon.com/Fintie-Case-Apple-iPad-Inch/dp/B00FB345SO>, Earliest review date of Dec. 1, 2013, Downloaded on Apr. 29, 2019.

“BMOUO Kids Case for New iPad Mini 5 2019/iPad Mini 4 2015—Light Weight Shockproof Protective Convertible Handle Stand Case Cover for Apple Mini 5th Generation 7.9" 2019—Blue”, <https://www.amazon.com/BMOUO-Kids-Case-iPad-Mini/dp/B07Q2GJL14>, Earliest review date of Apr. 12, 2015, Downloaded on Apr. 29, 2019.

“HDE Case for iPad Air 2—Kids Shockproof Bumper Hard Cover Handle Stand with Built in Screen Protector for Apple iPad Air 2—2014 Release 2nd Generation (Green)”, <https://www.amazon.com/dp/B01F48CWO0>, Earliest review date of May 10, 2016, Downloaded on Apr. 29, 2019.

“HDE Case for iPad Air—Kids Shockproof Bumper Hard Cover Handle Stand with Built in Screen Protector for Apple Pad Air 1—2013 Release 1st Generation (Red)”, <https://www.amazon.com/dp/B01F7QMJOA>, Earliest review date of Jun. 5, 2016, Downloaded on Apr. 29, 2019.

“AVAWO Kids Case for New iPad 9.7 2017 & 2018 Release—Light Weight Shock Proof Convertible Handle Stand Friendly Kids Case

for iPad 9.7-inch 2017 & 2018 Latest Gen (iPad 5th & 6th Gen)—Blue”, <https://www.amazon.com/AVAWO-Kids-Case-iPad-Release/dp/B06ZYBSGSF>, Earliest review date of May 5, 2017, Downloaded on Apr. 29, 2019.

“Bear Motion Case for All-New Fire 7 Tablet with Alexa—Anti Slip Shockproof Light Weight Kids Friendly Protective Base for Amazon Kindle Fire 7 2017 (ONLY for 7th Generation 2017 Model) (Red)”, <https://www.amazon.com/Bear-Motion-All-New-Tablet-Alexa/dp/B071L7WS87>, Earliest review date of Jun. 9, 2017, Downloaded on Apr. 26, 2019.

“Amazon Kid-Proof Case for Amazon 190+ Shares Fire HD 8 Tablet (Compatible with 7th and 8th Generation Tablets, 2017-2018 Releases), Yellow”, <https://www.amazon.com/Amazon-Kid-Proof-Compatible-Generation-2017-2018/dp/B07CG7HJ5F>, Earliest review date of Jun. 12, 2017, Downloaded on Apr. 25, 2019.

“Fintie Silicone Case for all-new Amazon Fire 7 Tablet (7th Generation, 2017 Release)—[Honey Comb Upgraded Version] [Kids Friendly] Light Weight [Anti Slip] Shock Proof Protective Cover, Blue”, <https://www.amazon.com/Fintie-Silicone-all-new-Generation-Release/dp/B0725SDWHR>, Earliest review date of Jun. 15, 2017, Downloaded on Apr. 25, 2019.

“MoKo Case for All-New Amazon Fire HD 10 Tablet (7th Generation, 2017 Release)—[Honey Comb Series] Light Weight Shockproof Soft Silicone Back Cover [Kids Friendly] for Fire HD 10.1" Tablet, Black”, <https://www.amazon.com/dp/B075Q51FRC>, Earliest review date of Oct. 22, 2017, Downloaded on Apr. 29, 2019.

“LTROP Shock Proof Case for Fire HD 8 2018/2017 Tablet—Kids Shockproof Convertible Handle Light Weight Protective Stand Case for Fire HD 8-inch (8th Gen & 7th Generation, 2018/2017 Release), Rose”, <https://www.amazon.com/LTROP-Shock-Proof-Case-Tablet/dp/B075FLR81D>, Earliest review date of Nov. 9, 2017, Downloaded on Apr. 26, 2019.

“Hikig Car Headrest Mount Holder for Kids All Kindle Fire—Kindle Fire HD 6/HD 7/HD X7/HD X9/HD 6 (2014)/HD 7 (2014)/HD 6 (Kid Edition)/HD 7 (Kid Edition)/New Fire 7/HD 8/HD 10”, <https://www.amazon.com/Hikig-Headrest-Mount-Holder-Kindle/dp/B076SZ62X2>, Earliest review date of Feb. 14, 2018, Downloaded on Apr. 26, 2019.

* cited by examiner

FIG. 1

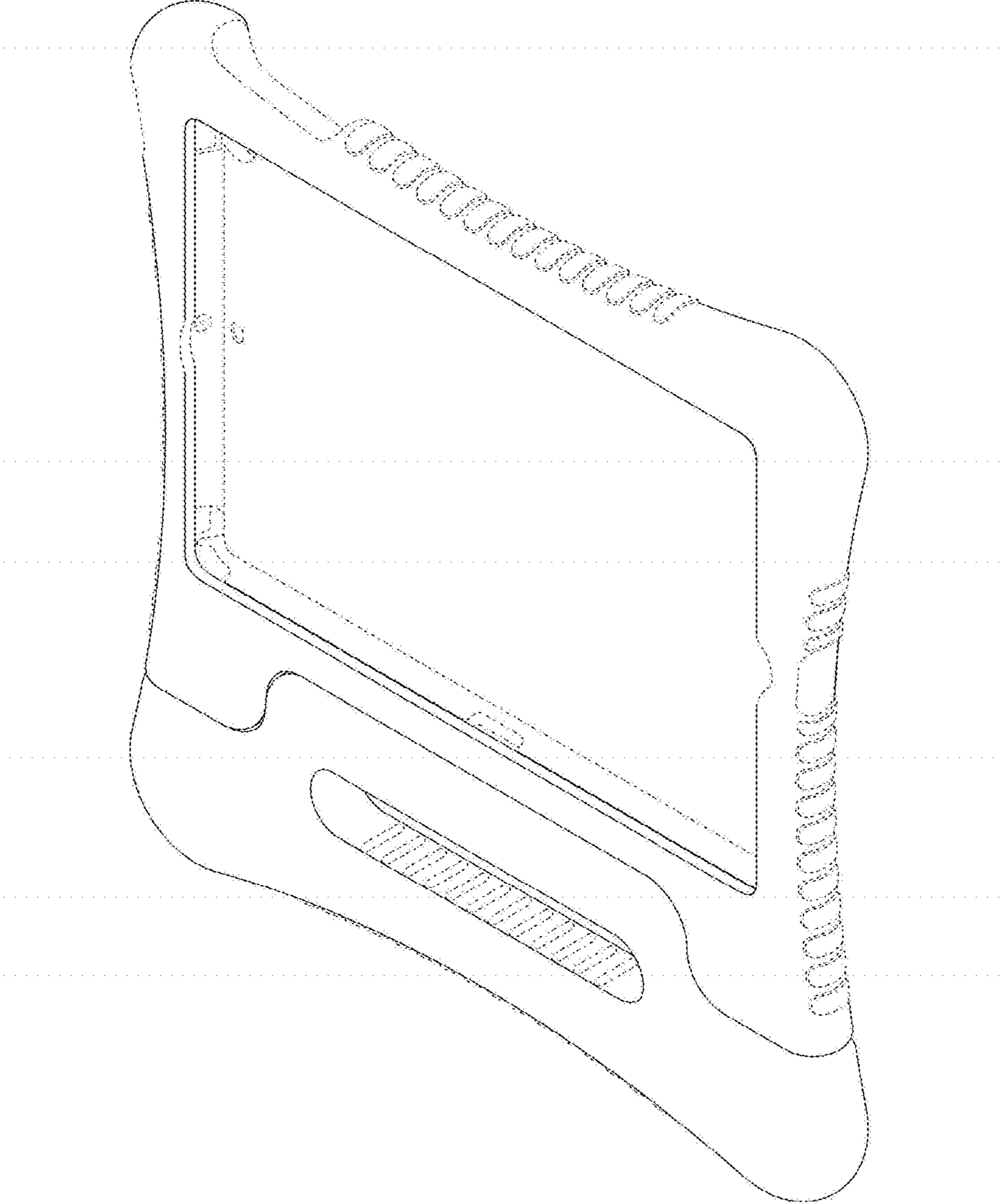

FIG. 2

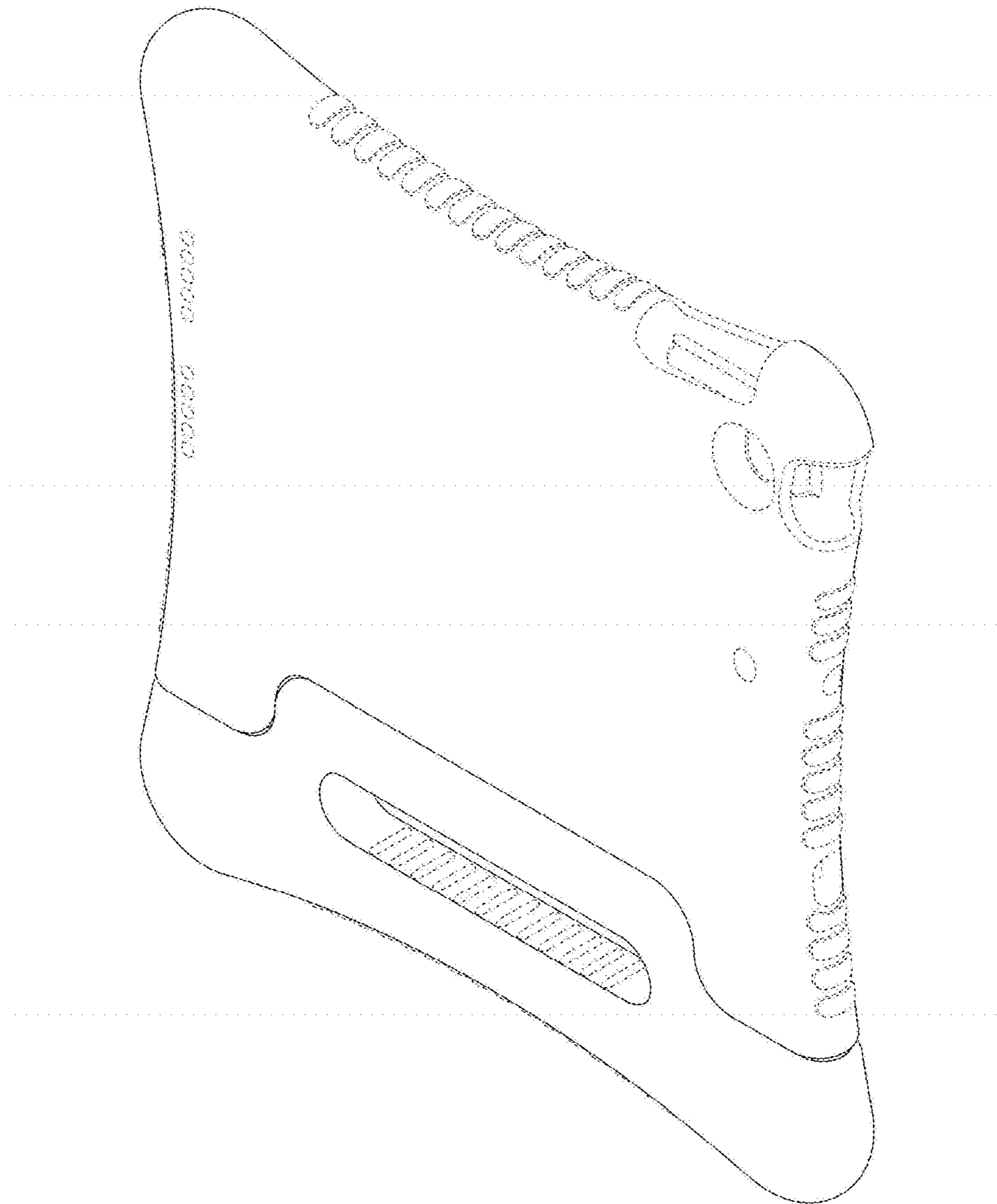

FIG. 3

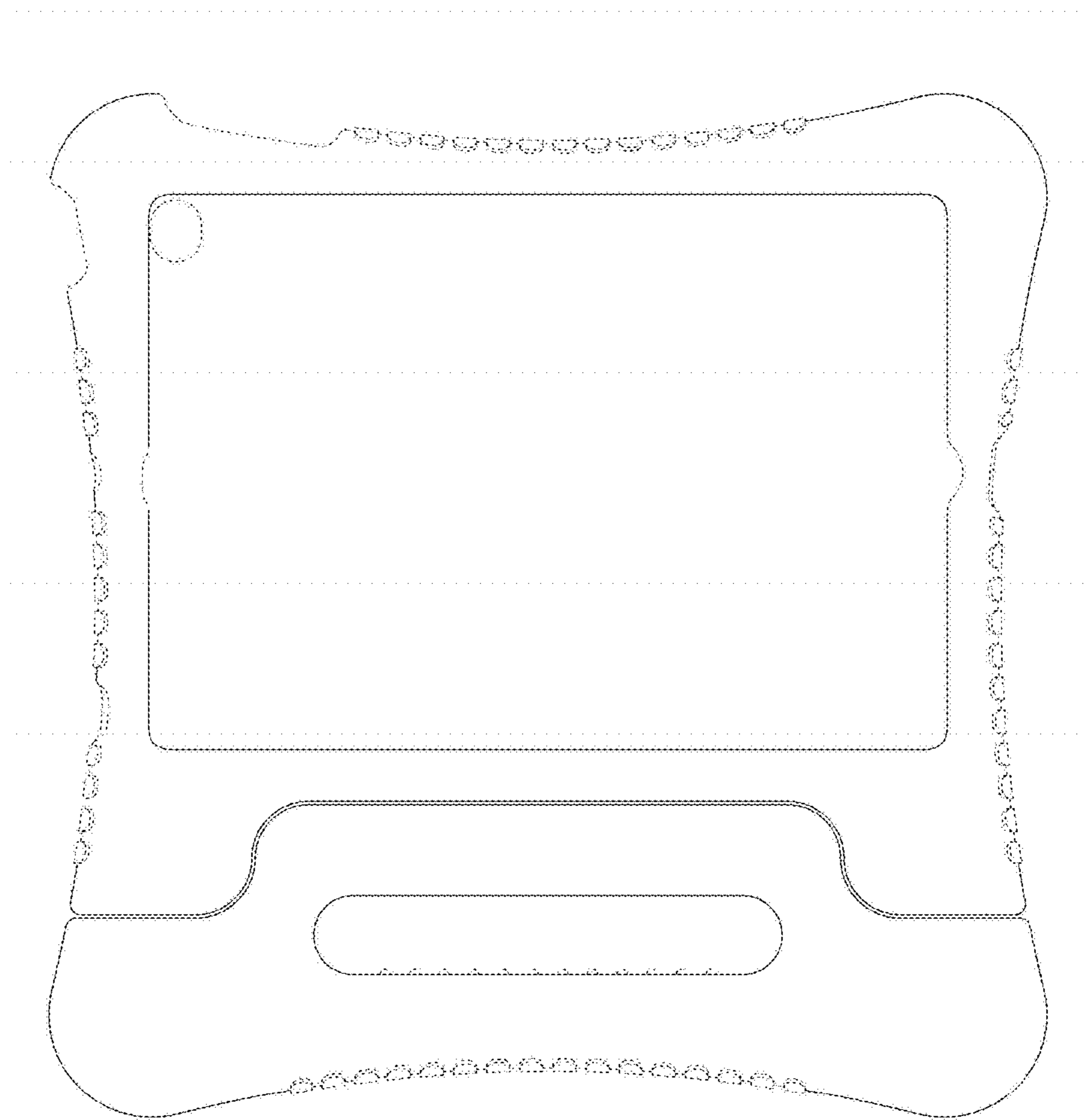

FIG. 4

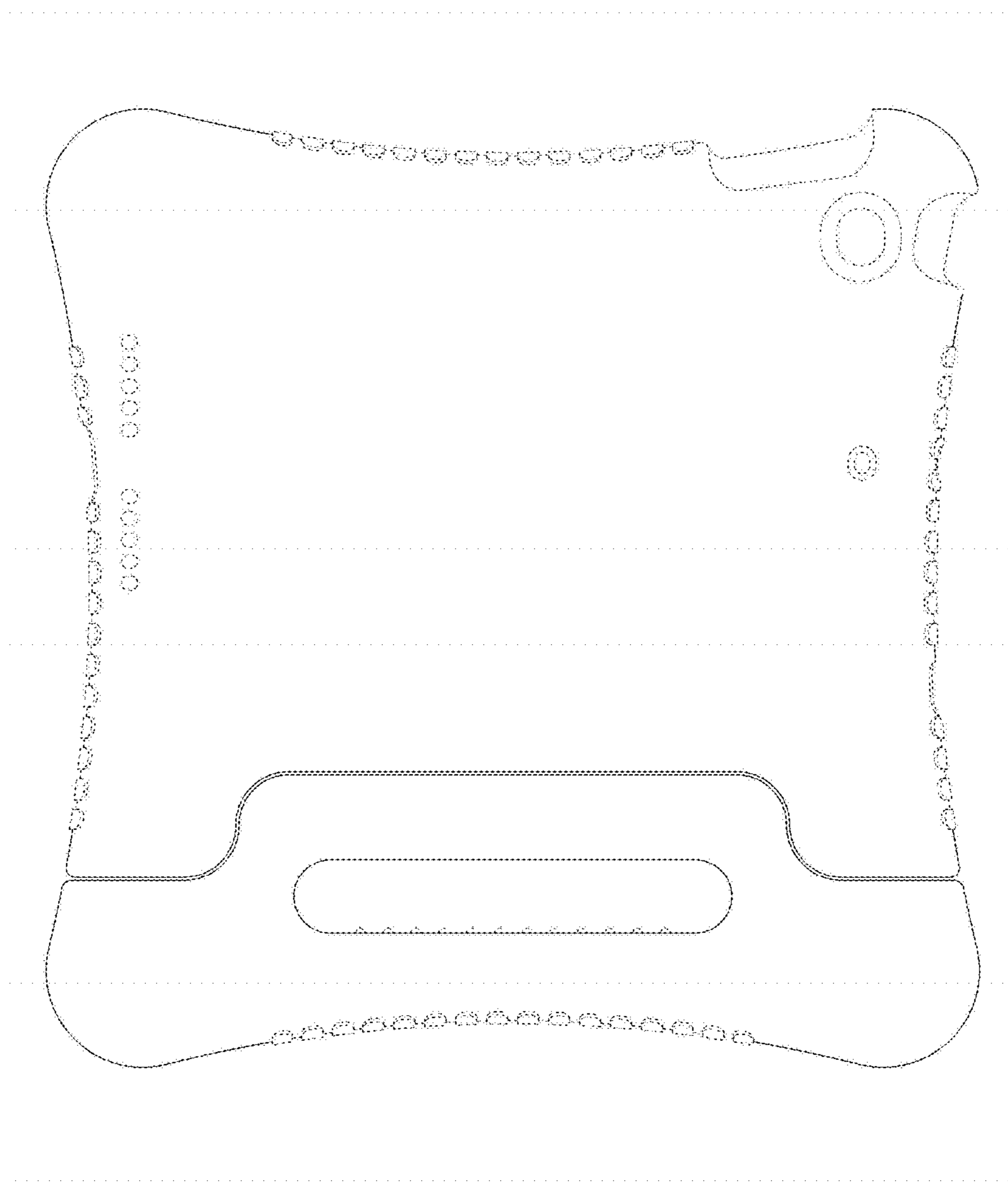

FIG. 5

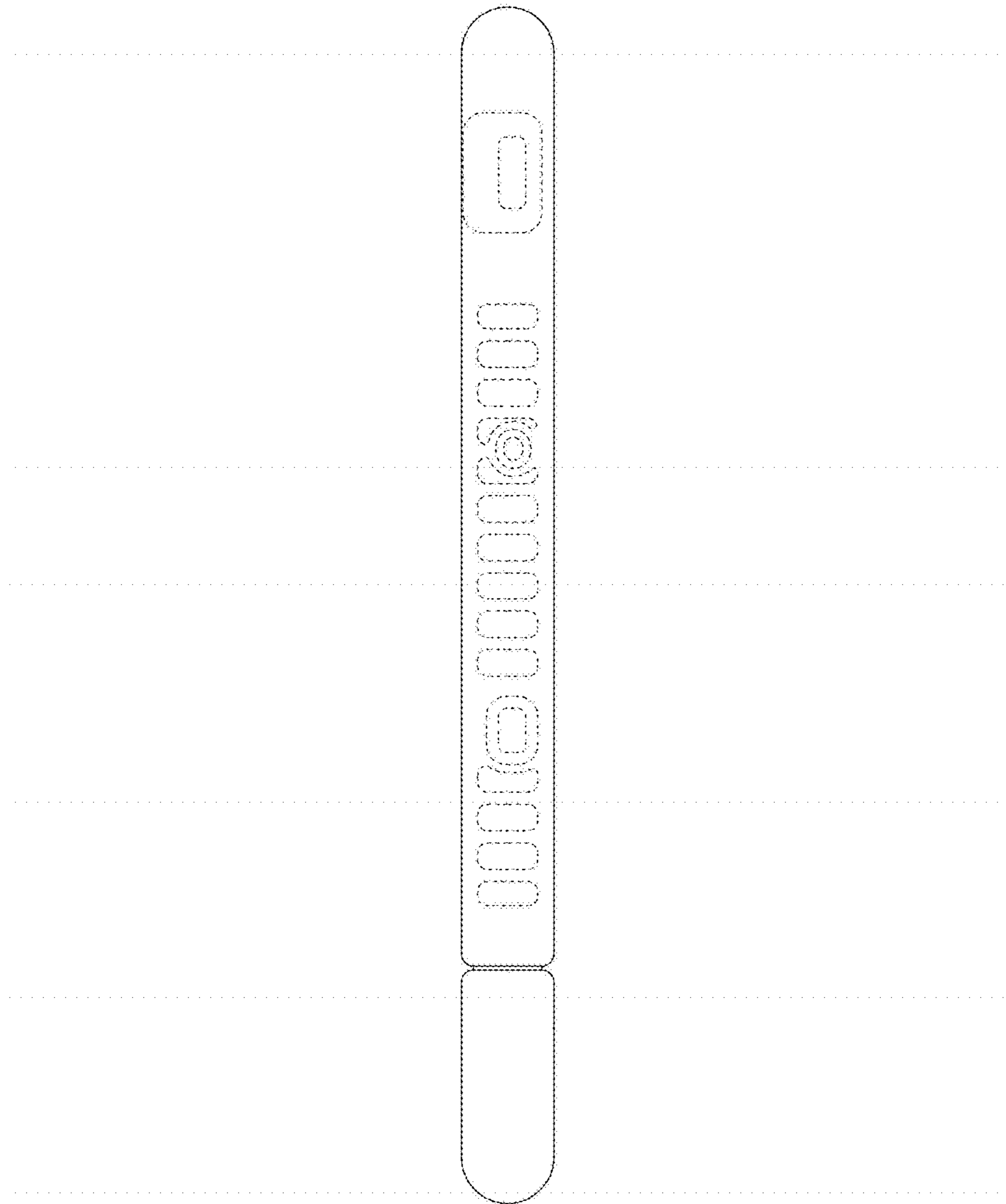

FIG. 6

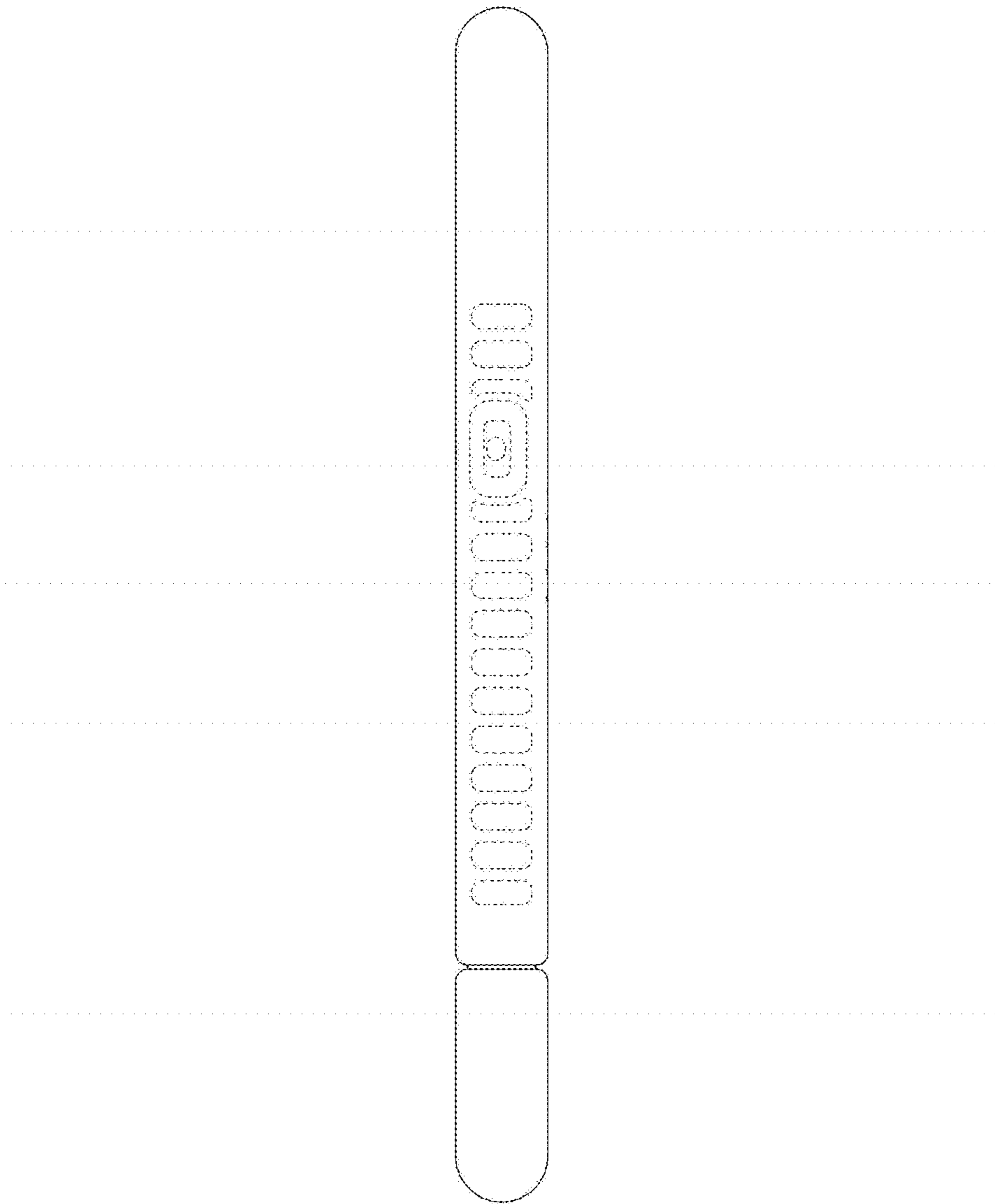

FIG. 7



FIG. 8

