



US00D862340S

(12) **United States Design Patent** (10) **Patent No.:** **US D862,340 S**
Le (45) **Date of Patent:** **** Oct. 8, 2019**

(54) **FOLDING STEP**
(71) Applicant: **S.P.E.P. ACQUISITION CORP.**, Long Beach, CA (US)
(72) Inventor: **Tam Le**, Garden Grove, CA (US)
(73) Assignee: **S.P.E.P. ACQUISITION CORP.**, Long Beach, CA (US)
(**) Term: **15 Years**
(21) Appl. No.: **29/655,976**
(22) Filed: **Jul. 9, 2018**
(51) **LOC (12) Cl.** **12-16**
(52) **U.S. Cl.**
USPC **D12/203**
(58) **Field of Classification Search**
USPC D12/203, 162, 125, 400; D25/62, 63, 65, D25/69
CPC B60R 3/02; B60R 3/007
See application file for complete search history.

D513,217 S * 12/2005 Daws D12/203
D594,799 S * 6/2009 Schnebele D12/203
D796,405 S * 9/2017 Atkins D12/203
D806,625 S * 1/2018 Hoffman D12/203

* cited by examiner

Primary Examiner — Michelle E. Wilson
Assistant Examiner — Clese Moore, Jr.
(74) *Attorney, Agent, or Firm* — Karish & Bjorgum, PC

(57) **CLAIM**

The ornamental design for folding step, as shown and described.

DESCRIPTION

FIG. 1 is top right perspective view of the folding step of my new design with a step portion folded down.
FIG. 2 is a back right perspective view of the folding step of FIG. 1.
FIG. 3 is right side view of the folding step of FIG. 1, with the left side view being a mirror image of FIG. 3.
FIG. 4 is front view of the folding step of FIG. 1.
FIG. 5 is a rear view of the folding step of FIG. 1.
FIG. 6 is a top view of the folding step of FIG. 1.
FIG. 7 is a bottom view of the folding step of FIG. 1.
FIG. 8 is top right perspective view of the folding step of my new design of FIG. 1, but with the step portion folded.
FIG. 9 is a right side view of the folding step of FIG. 5, with the left side view being a mirror image of FIG. 3.
FIG. 10 is front side view of the folding step of FIG. 5
FIG. 11 is rear view of the folding step of FIG. 5.
FIG. 12 is a top view of the folding step of FIG. 5; and,
FIG. 13 is a bottom view of the folding step of FIG. 5.
The features shown in dashed lines form no part of the design and are not claimed.

(56) **References Cited**

U.S. PATENT DOCUMENTS

4,462,486 A * 7/1984 Dignan B60R 3/02
182/91
D276,716 S * 12/1984 Dignan D12/203
D296,431 S * 6/1988 Yont D12/203
D315,134 S * 3/1991 Springer D12/203
D316,394 S * 4/1991 Carr D12/203
D445,076 S * 7/2001 Weinerman D12/203
D448,335 S * 9/2001 Ehnes D12/203
D449,264 S * 10/2001 Weinerman D12/203
D463,345 S * 9/2002 Cipolla D12/162
6,471,002 B1 * 10/2002 Weinerman B60R 3/02
182/90
6,511,086 B2 * 1/2003 Schlicht B60R 3/02
280/163
D505,900 S * 6/2005 Oravec, III D12/203
D506,171 S * 6/2005 Oravec, III D12/203

1 Claim, 4 Drawing Sheets

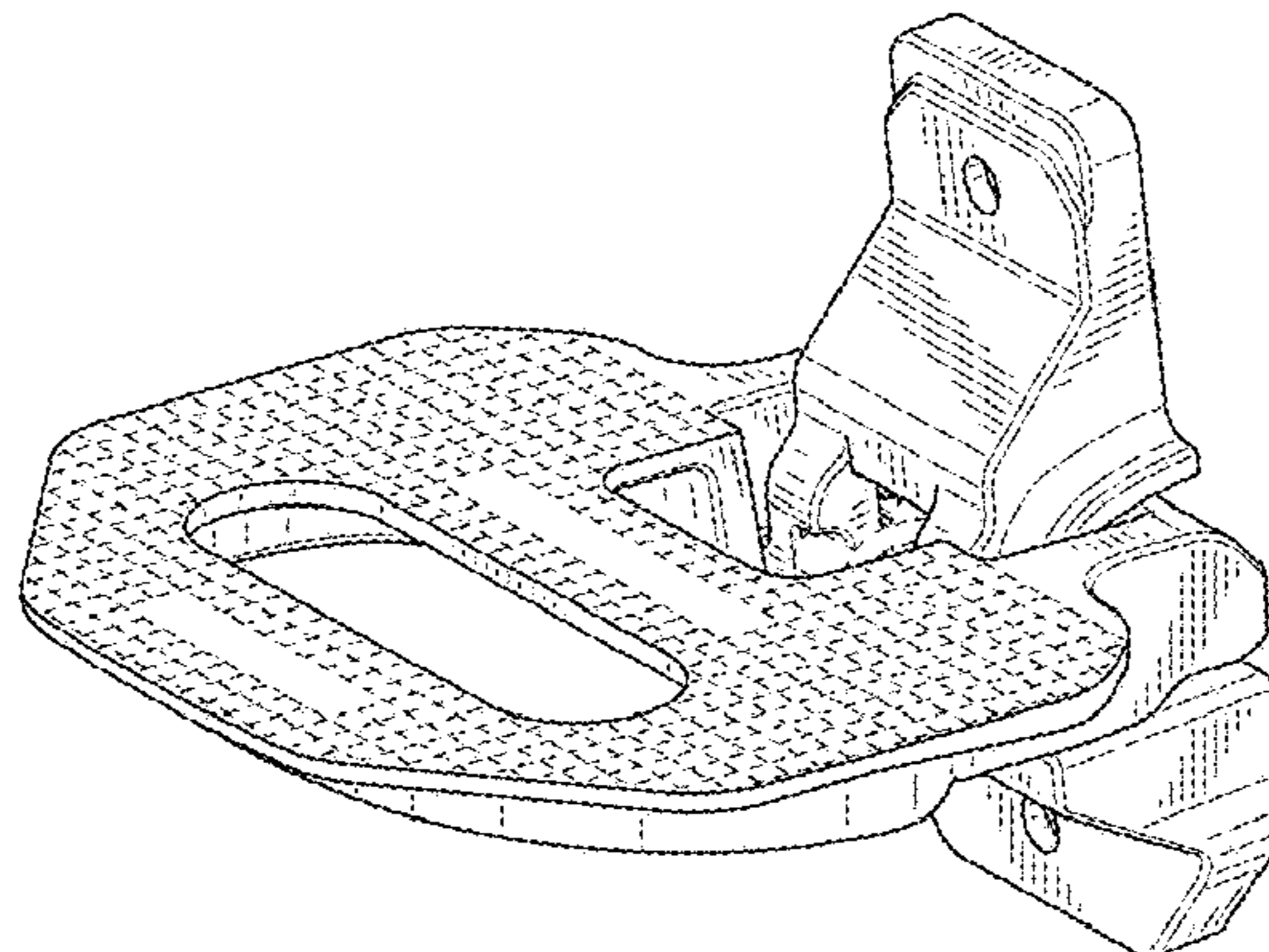

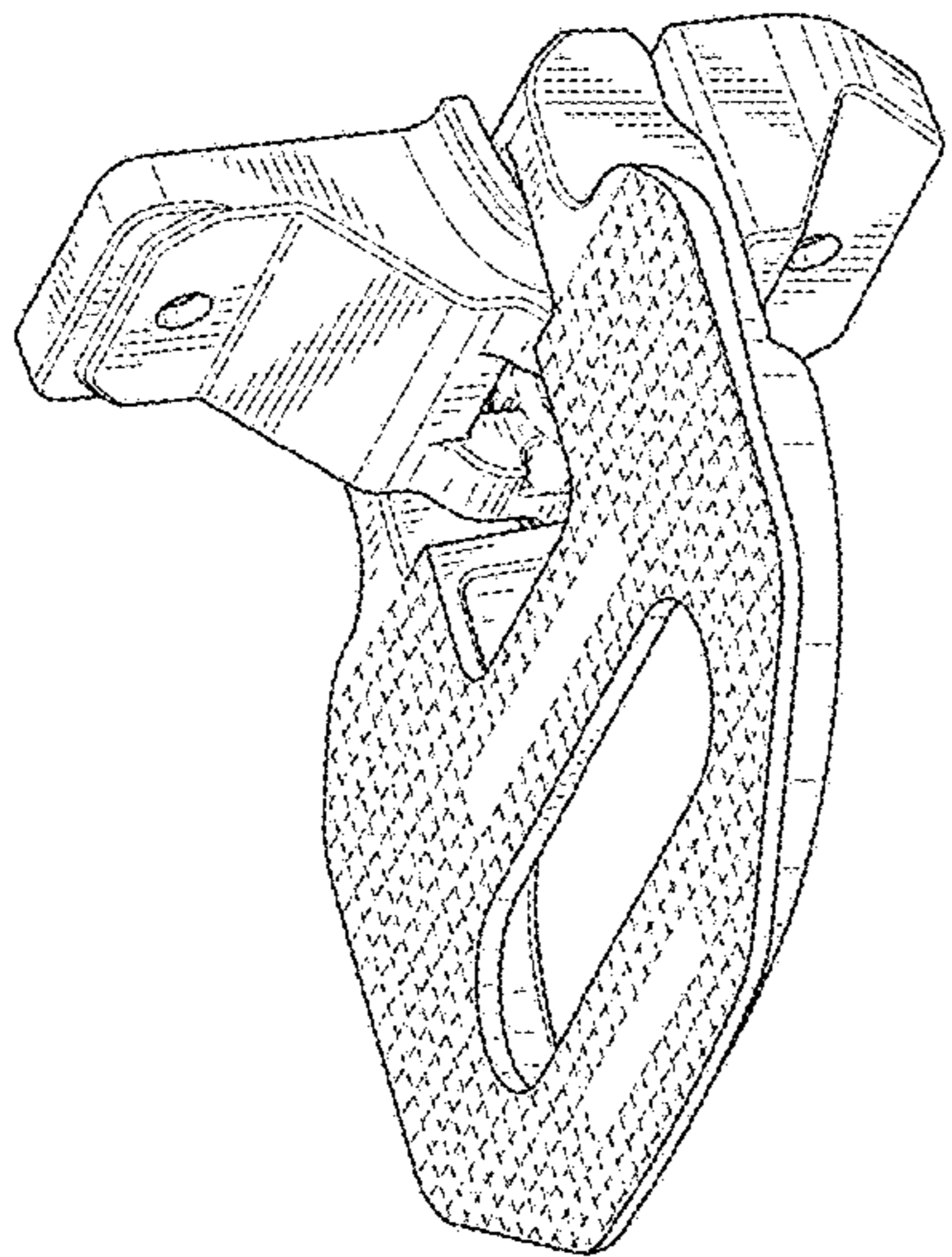

FIG. 1

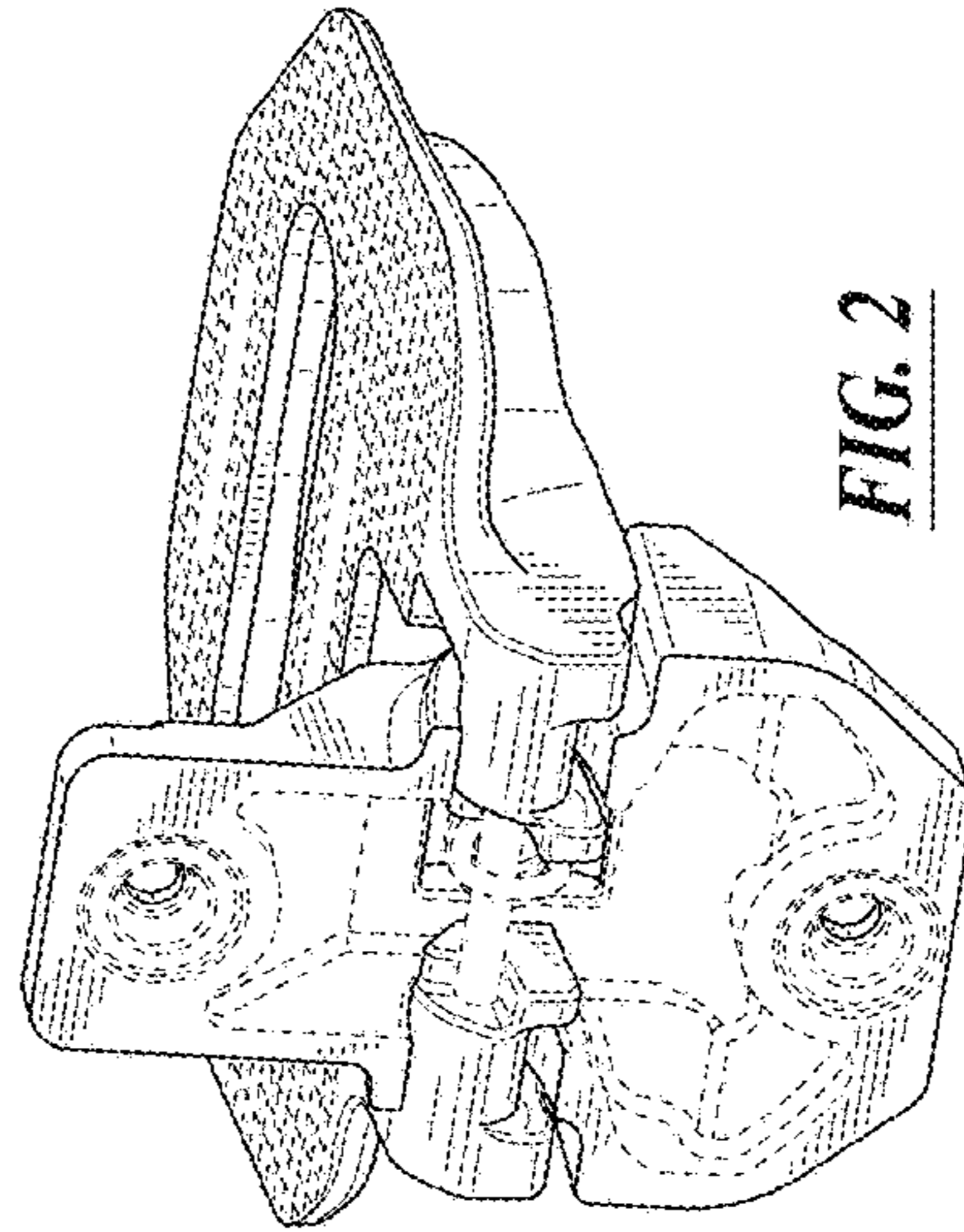

FIG. 2

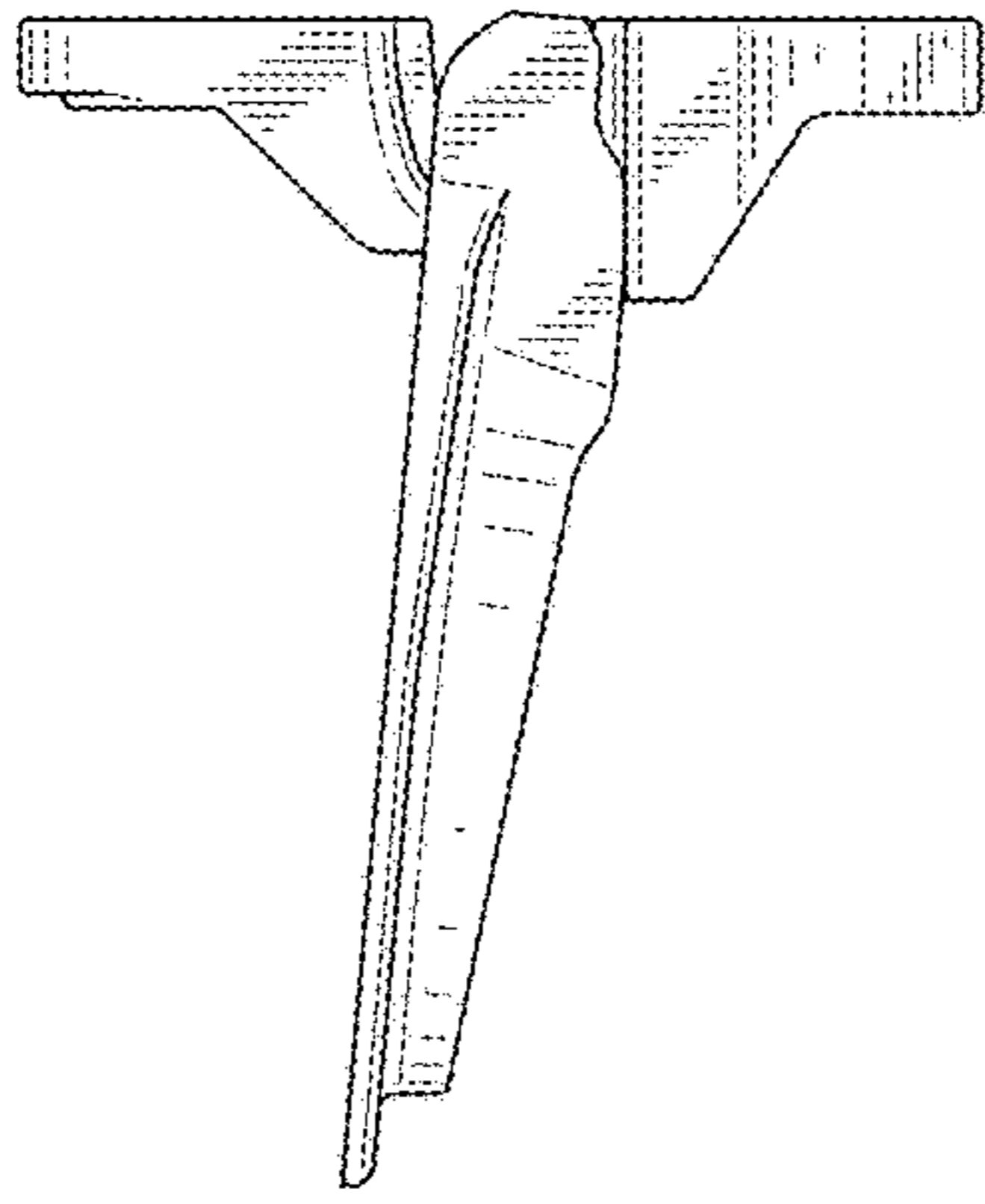

FIG. 3

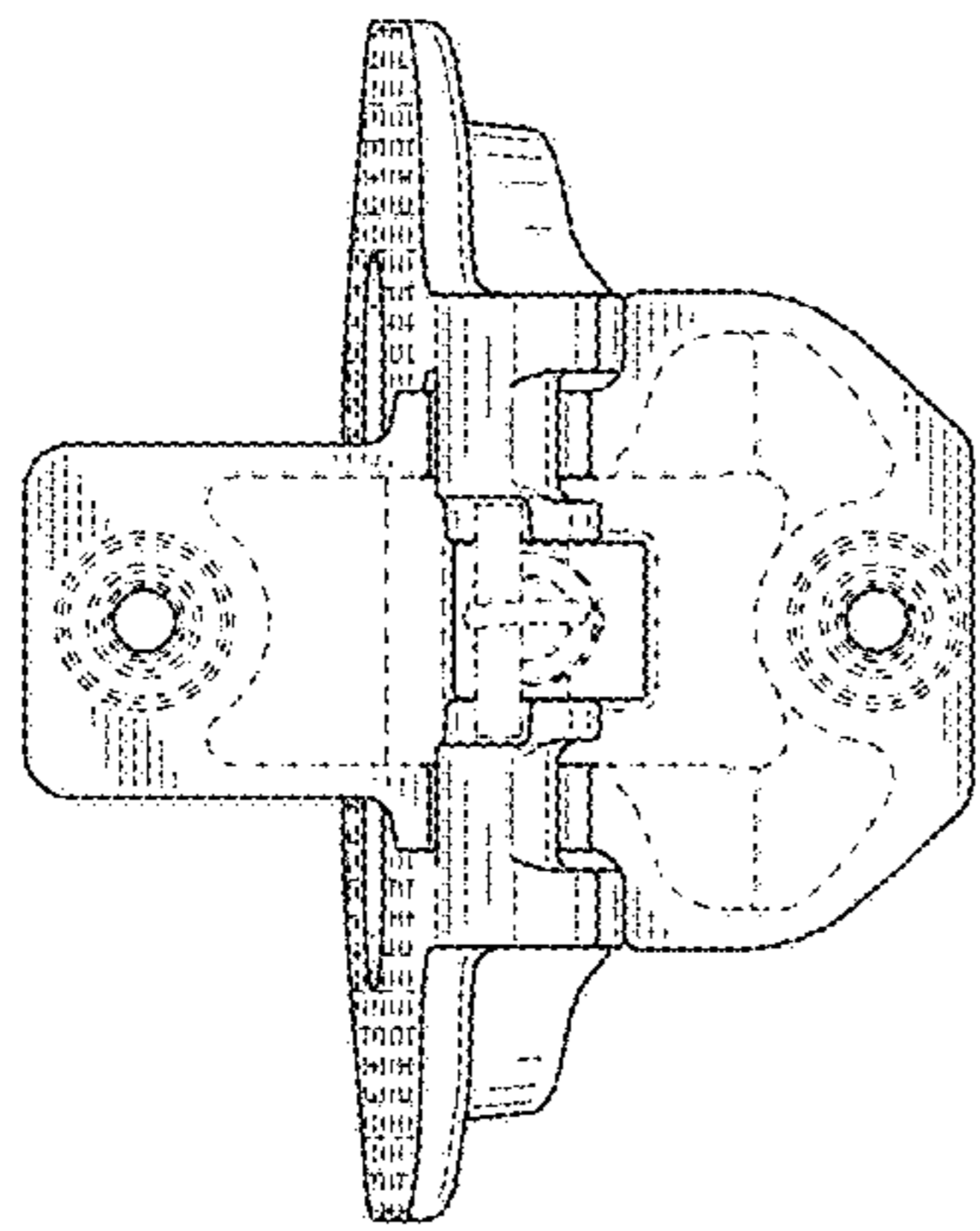

FIG. 5

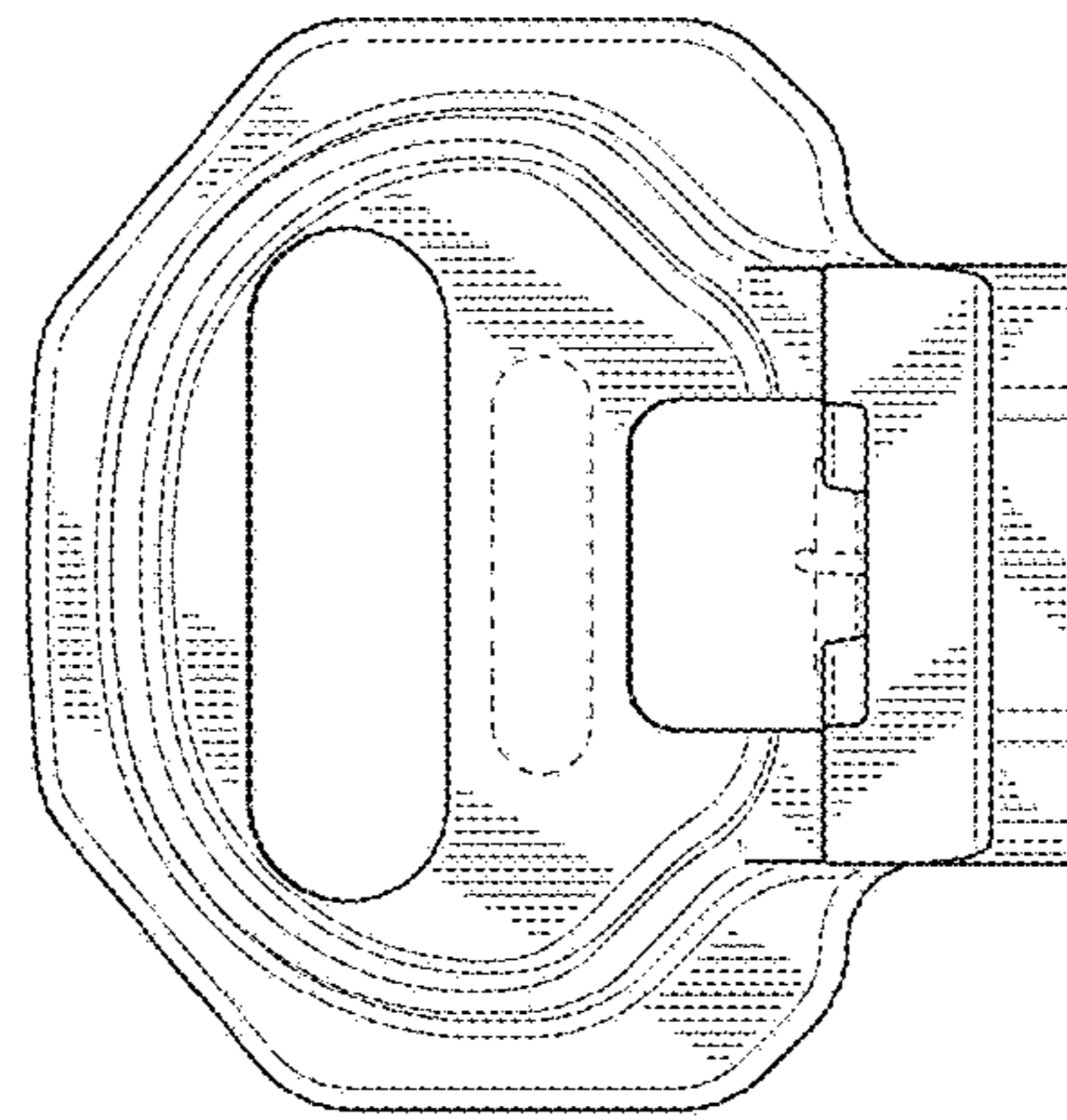

FIG. 7

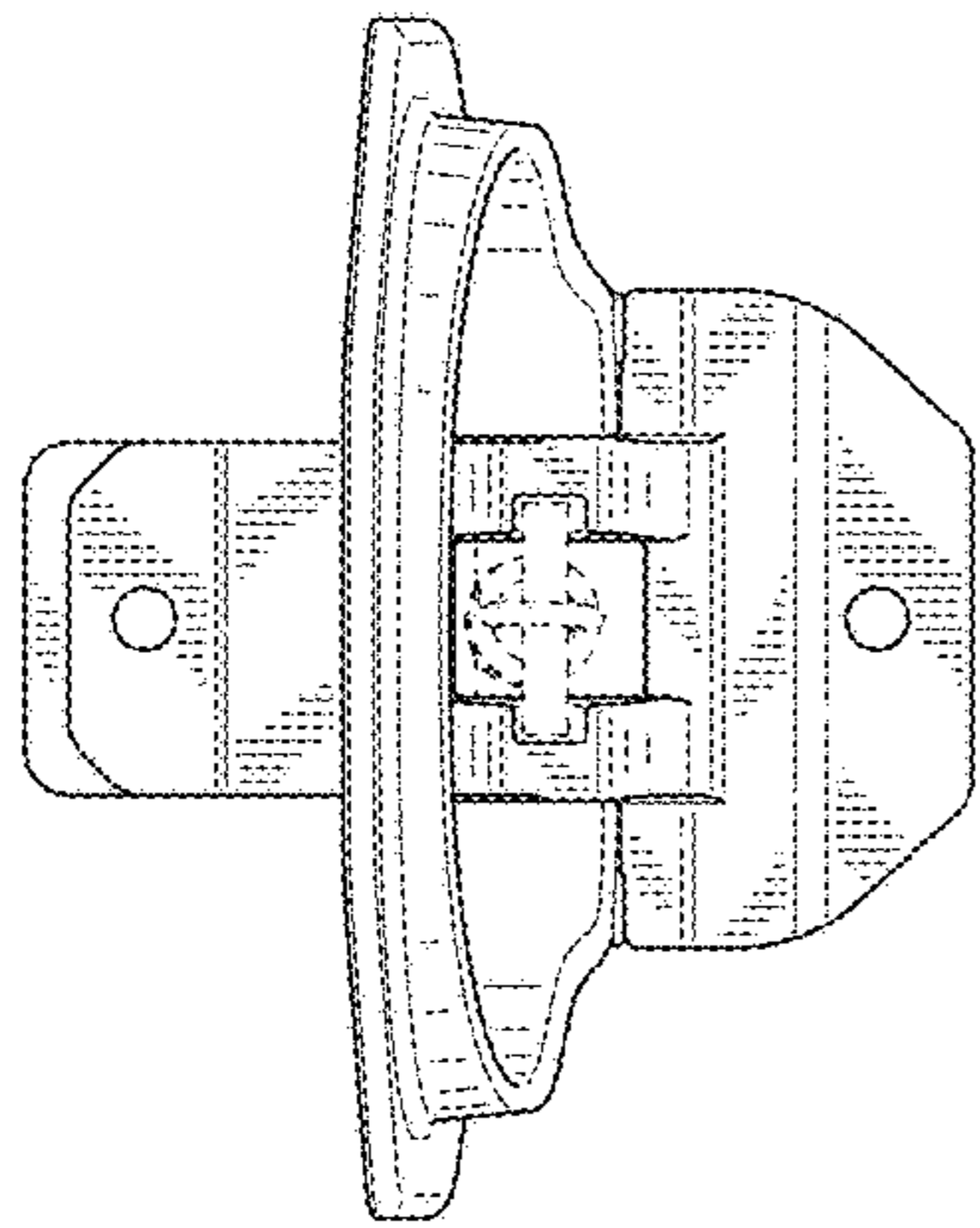

FIG. 4

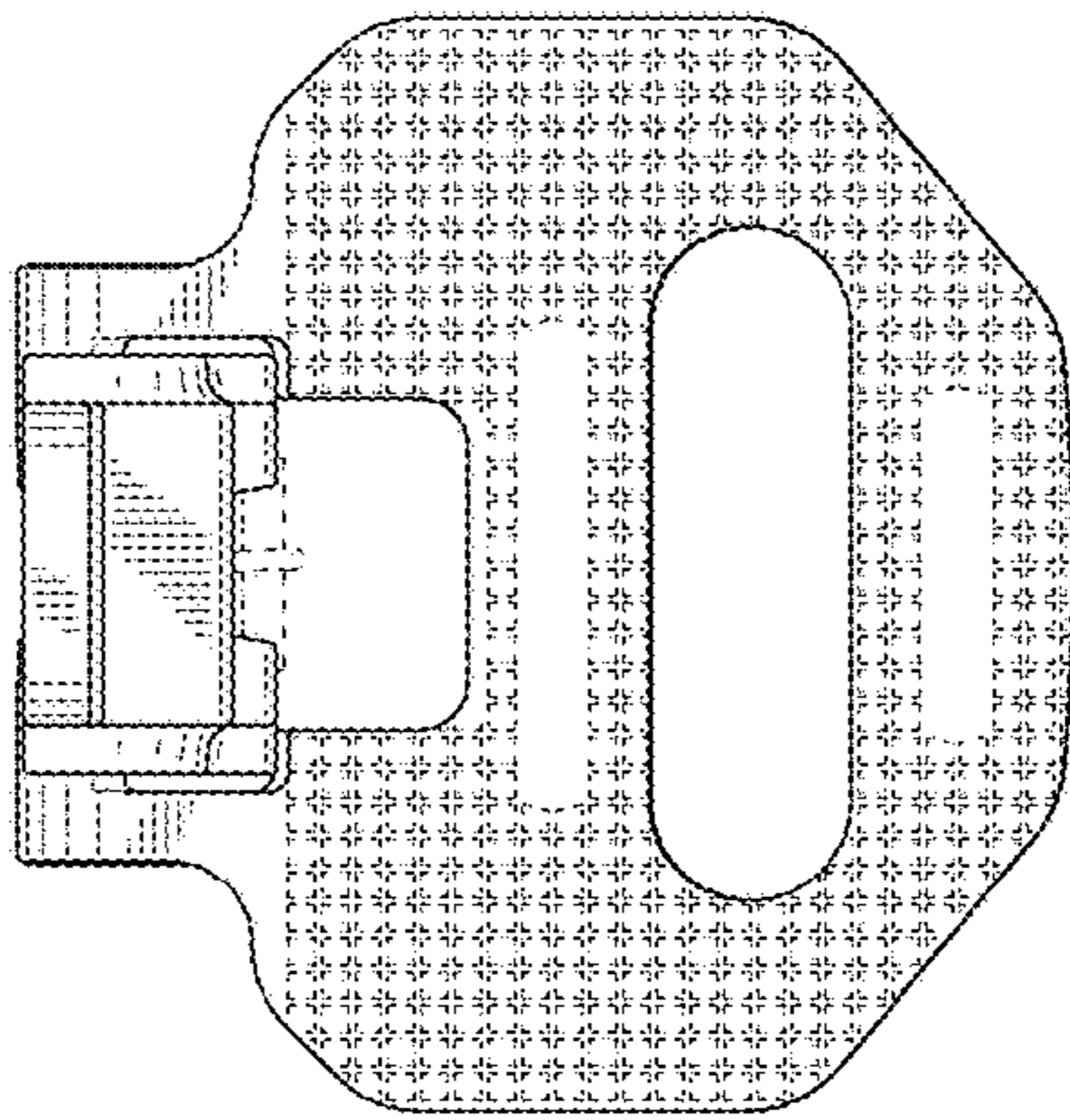

FIG. 6

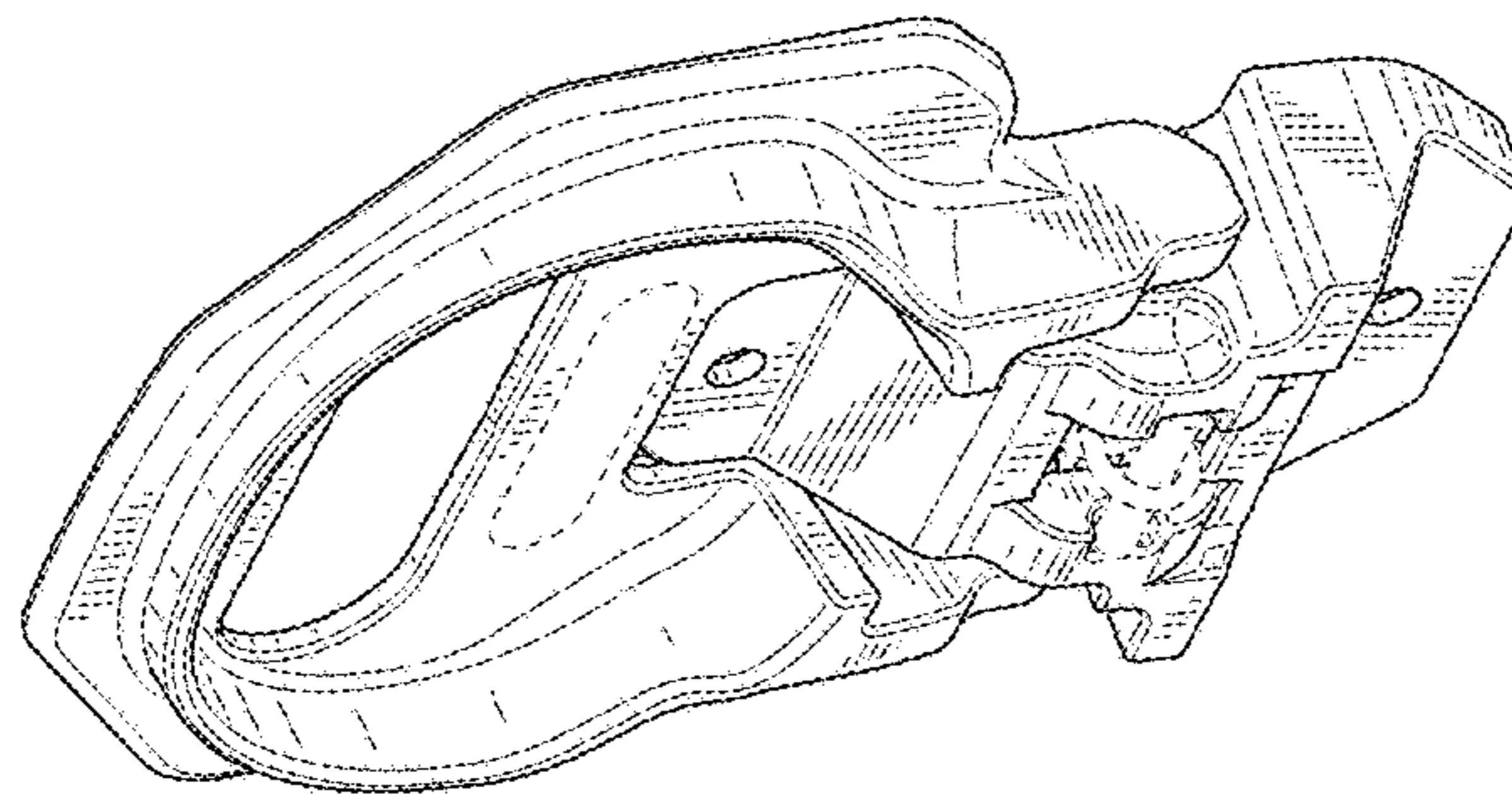

FIG. 8

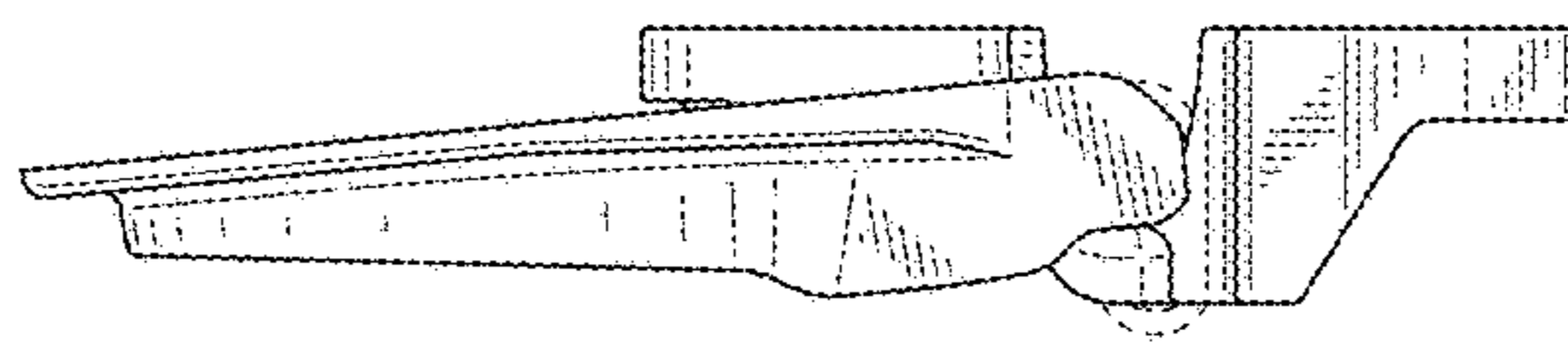

FIG. 9

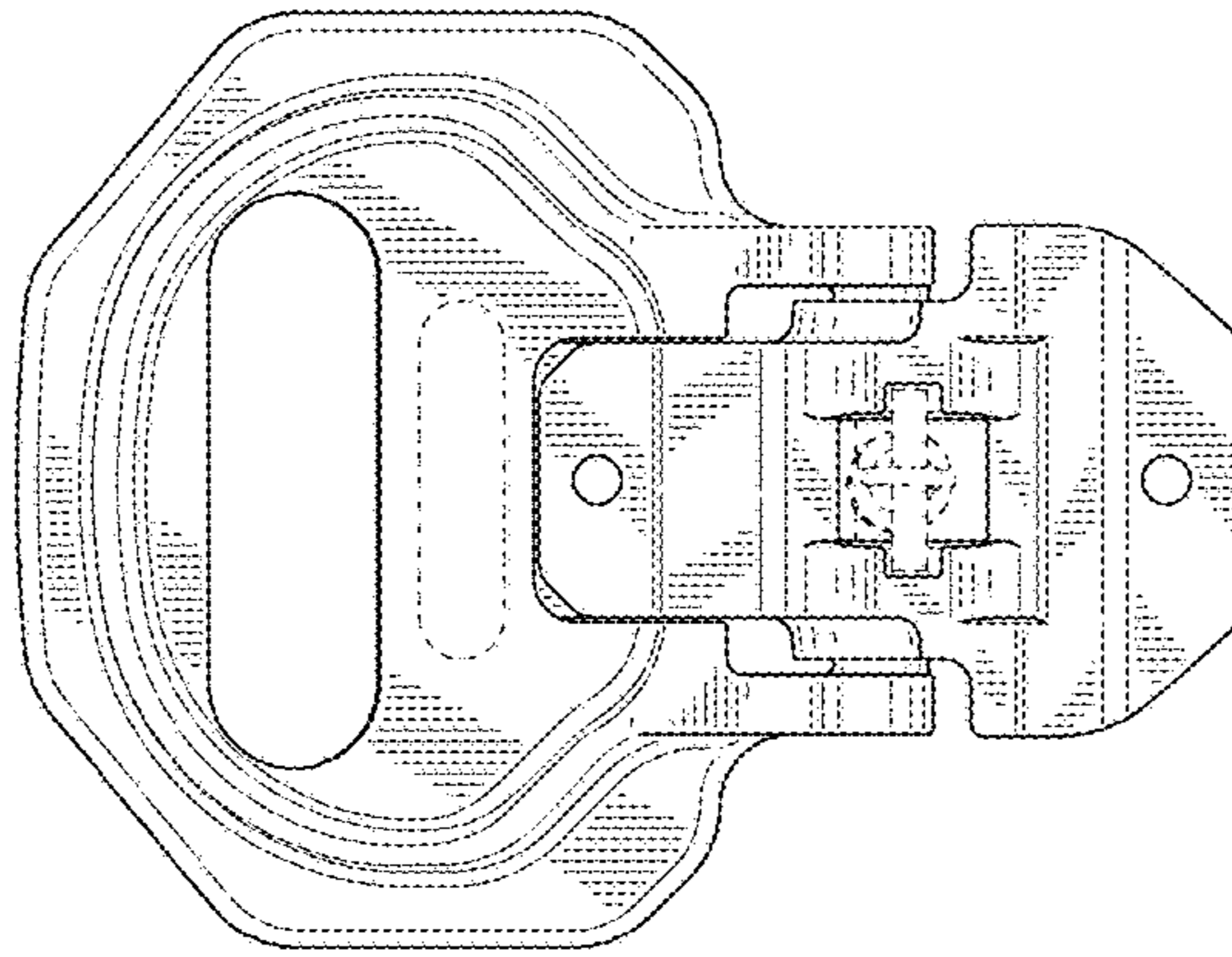

FIG. 10

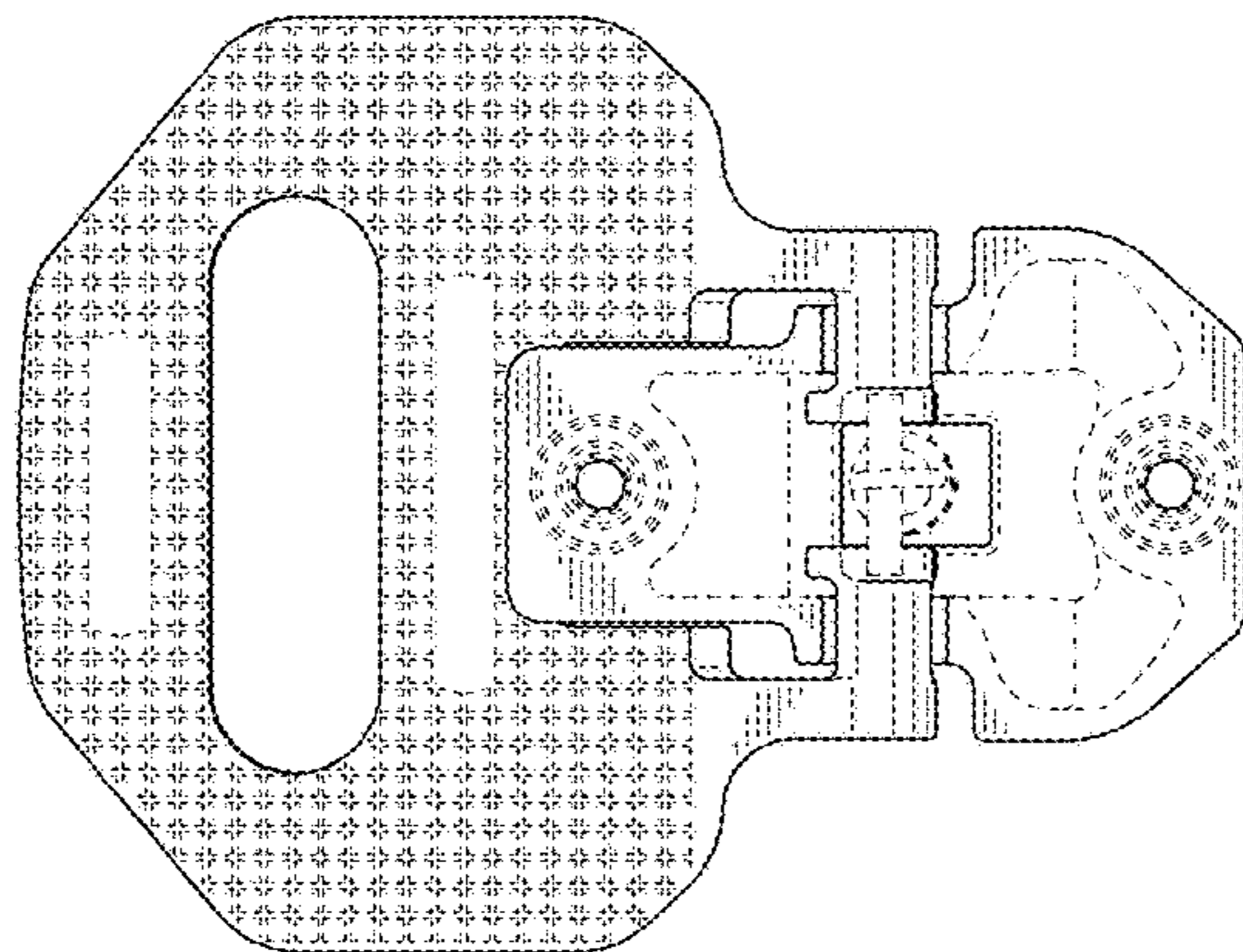

FIG. 11

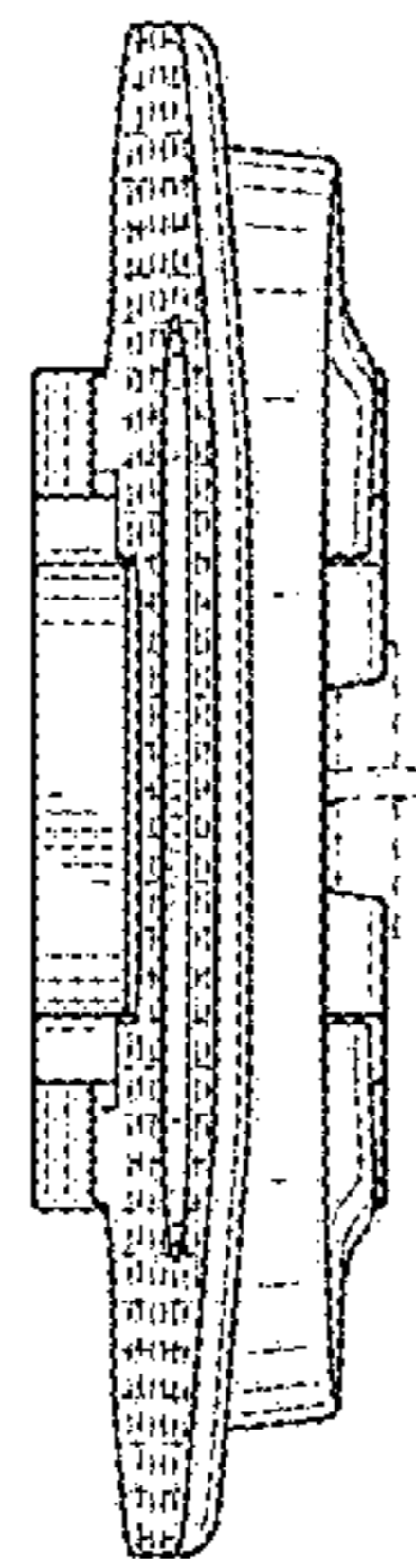

FIG. 12

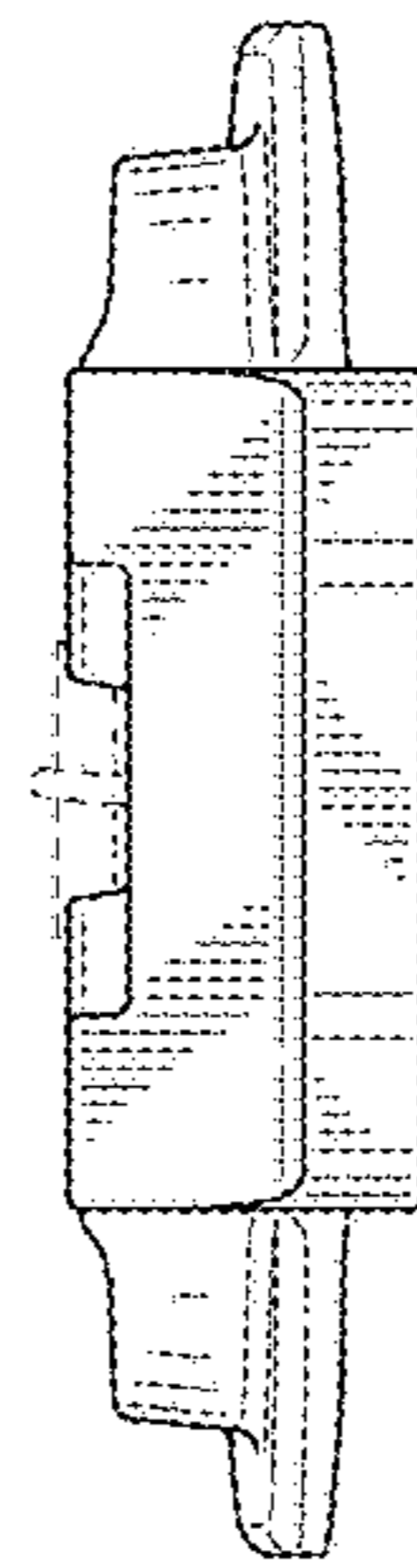

FIG. 13