

US00D862255S

(12) **United States Design Patent** (10) **Patent No.:** **US D862,255 S**
Erbacher et al. (45) **Date of Patent:** **** Oct. 8, 2019**

(54) **HYDRONIC ZONE CONTROLLER**

(71) Applicant: **Ademco Inc.**, Golden Valley, MN (US)

(72) Inventors: **Jonathan Erbacher**, Minneapolis, MN (US); **Travis Read**, Little Canada, MN (US); **Rajat Shail**, Stevensville, MI (US); **Cameron Vreeland**, Mound, MN (US); **Nathan Carlson**, Maple Grove, MN (US)

(73) Assignee: **Ademco Inc.**, Golden Valley, MN (US)

(**) Term: **15 Years**

(21) Appl. No.: **29/631,592**

(22) Filed: **Dec. 29, 2017**

(51) **LOC (12) Cl.** **10-04**

(52) **U.S. Cl.**
USPC **D10/49; D13/162**

(58) **Field of Classification Search**
USPC **D10/49, 50; D13/162, 162.1, 177**
CPC . **F23N 5/20; F23N 5/203; F23N 5/206; F23N 5/18; F23N 5/184; F23N 5/187; F23N 5/22; F23N 2025/12; F23N 2041/02; F24F 11/00; F24F 11/0012; F24F 11/0009; F24F 11/001; F24F 2011/0057; F24F 2011/0073; F24F 2011/0091; F24F 2011/0094; F24F 2011/0068; F24F 2011/0012; F24F 2011/0015; F24F 2011/0017; F21V 11/16; F21V 33/10; G05B 19/042; G05D 23/01; G05D 23/12; G05D 23/275; G05D 23/1902;**

(Continued)

(56) **References Cited**

U.S. PATENT DOCUMENTS

D290,694 S 7/1987 Shimizu et al.
D304,929 S 12/1989 Bench et al.

(Continued)

Primary Examiner — Antoine Duval Davis

(74) *Attorney, Agent, or Firm* — Shumaker & Sieffert, P.A.

(57) **CLAIM**

The ornamental design for a hydronic zone controller, as shown and described.

DESCRIPTION

FIG. 1 is a perspective view of a first embodiment of the hydronic zone controller;
 FIG. 2 is a front elevation view of the first embodiment of the hydronic zone controller of FIG. 1;
 FIG. 3 is a front elevation view of the first embodiment of the hydronic zone controller of FIG. 1 with user interface elements added;
 FIGS. 4-7 are left, right, top and bottom views, respectively, of the first embodiment of the hydronic zone controller of FIG. 1;
 FIG. 8 is a perspective view of a second embodiment of the hydronic zone controller;
 FIG. 9 is a front elevation view of the second embodiment of the hydronic zone controller of FIG. 8;
 FIG. 10 is a front elevation view of the second embodiment of the hydronic zone controller of FIG. 8 with user interface elements added;
 FIGS. 11-14 are left, right, top and bottom views, respectively, of the second embodiment of the hydronic zone controller of FIG. 8;
 FIG. 15 is a perspective view of a third embodiment of the hydronic zone controller;
 FIG. 16 is a front elevation view of the third embodiment of the hydronic zone controller of FIG. 15;
 FIG. 17 is a front elevation view of the third embodiment of the hydronic zone controller of FIG. 15 with user interface elements added; and,
 FIGS. 18-21 are left, right, top and bottom views, respectively, of the third embodiment of the hydronic zone controller of FIG. 15.

The portions illustrated in broken lines on the figures are for illustrative purposes only and form no part of the claimed design.

1 Claim, 21 Drawing Sheets

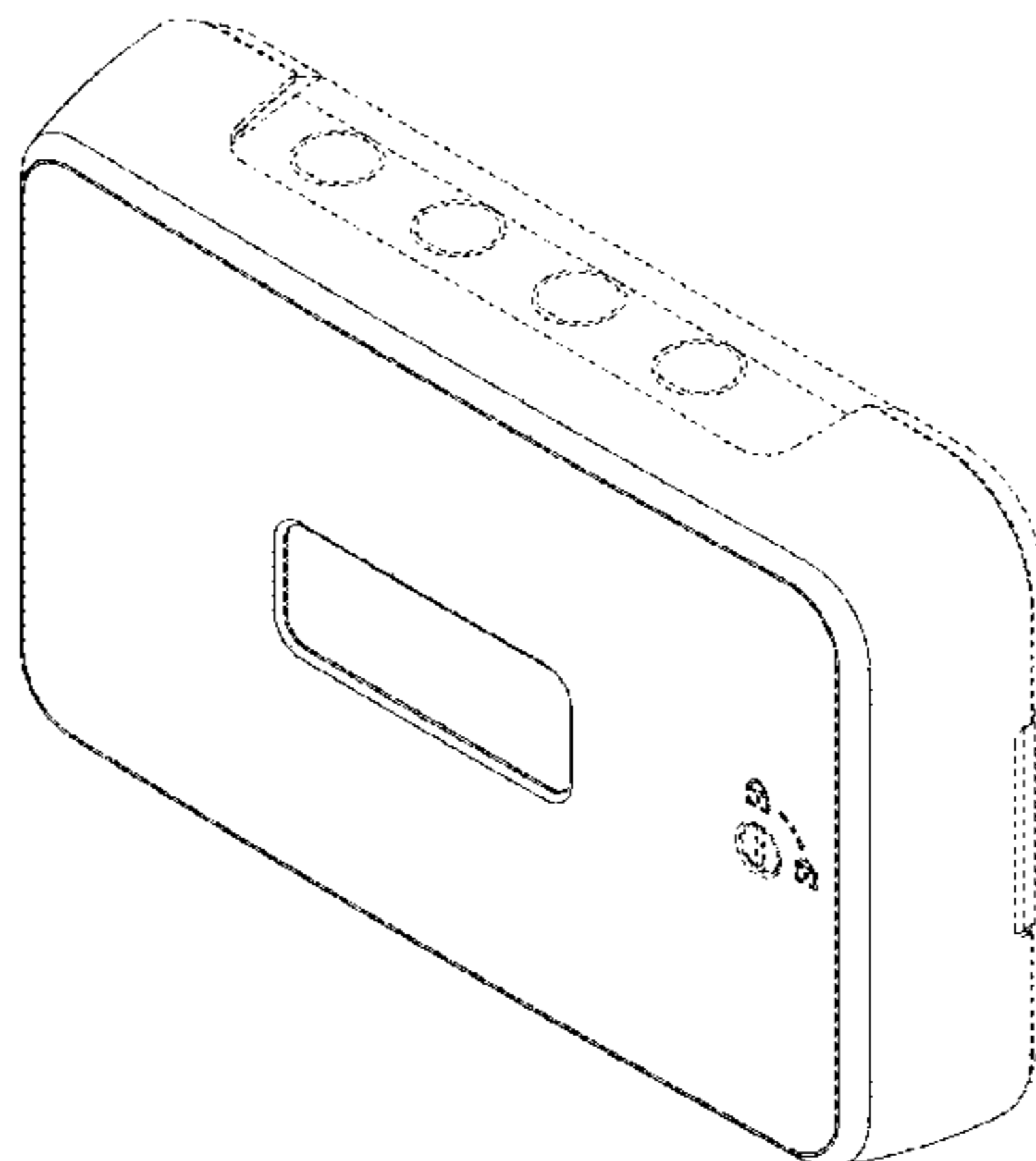

(58) **Field of Classification Search**

CPC G05D 23/1904; G05D 23/27502; G05D
23/27503; G05D 23/1919; G05D 23/19;
G05D 23/2723; G05D 23/00; G09F
13/22; G09F 9/53; G06F 1/1684; G06F
1/30; G06F 3/0362; G06F 3/038; H05B
33/0854; H05B 37/0218; H05K 5/0017;
H05K 5/0243; H05K 5/00; H05K 5/03;
H04M 2250/12; H04M 2250/22

See application file for complete search history.

(56) **References Cited**

U.S. PATENT DOCUMENTS

D312,612 S 12/1990 Seymour
D401,909 S 12/1998 Richman et al.
D558,684 S 1/2008 Dornauer et al.
D562,261 S 2/2008 Takach et al.
D562,262 S 2/2008 Takach et al.
D563,325 S 3/2008 Takach et al.
D570,791 S 6/2008 Takach et al.
D571,734 S 6/2008 Takach et al.
D602,445 S 10/2009 Liu
D678,218 S * 3/2013 Sheen D13/168
D680,501 S 4/2013 Elliott et al.
D693,311 S 11/2013 Biller et al.
D727,857 S 4/2015 Acera et al.
D733,591 S * 7/2015 Golden D10/50
D769,743 S 10/2016 Li
D772,085 S 11/2016 Howe et al.
D792,353 S 7/2017 Yoshida et al.
D792,789 S * 7/2017 Read D10/50
D804,432 S 12/2017 Burkell et al.
10,096,996 B1 * 10/2018 Lin H02J 1/00

* cited by examiner

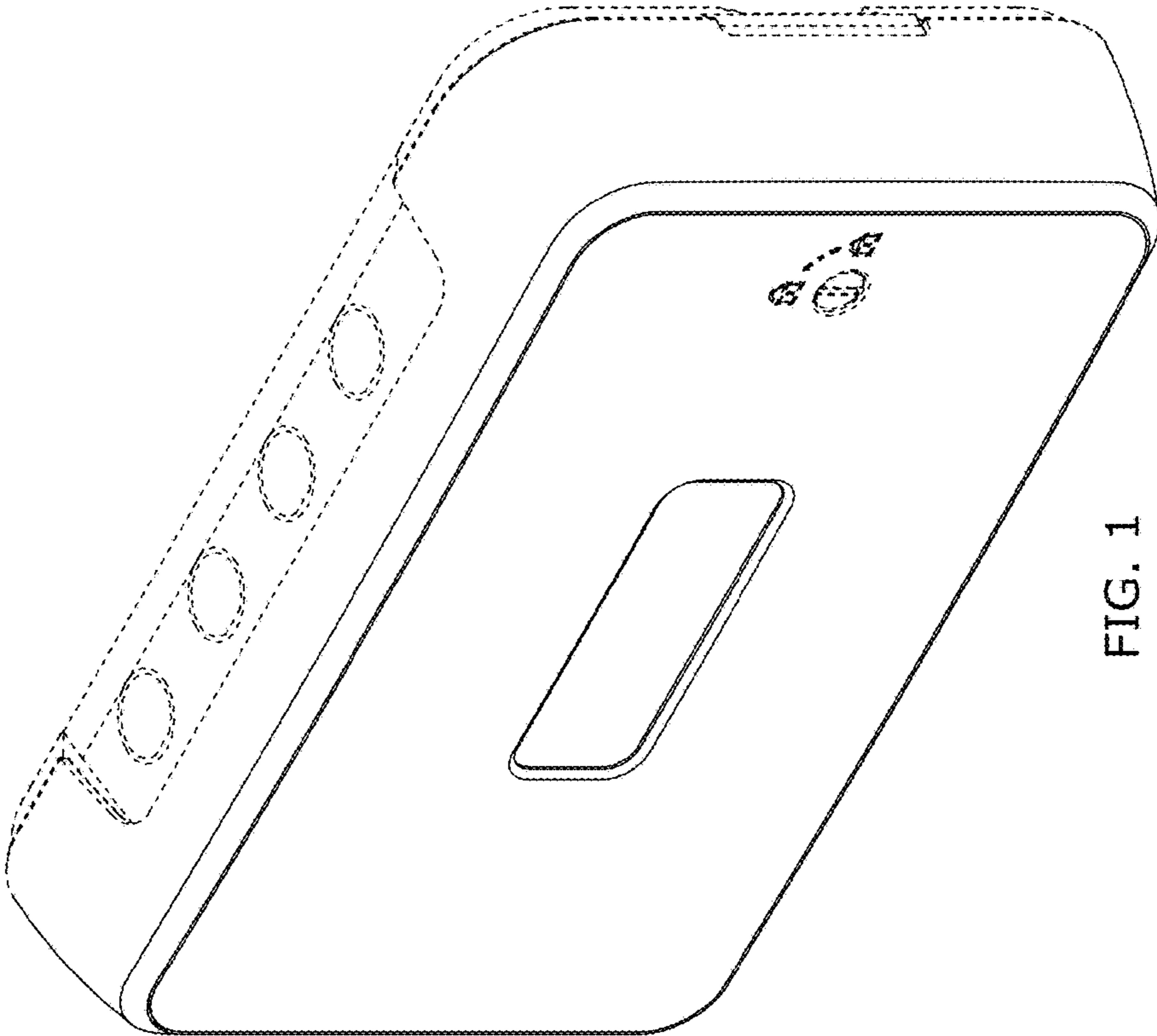

FIG. 1

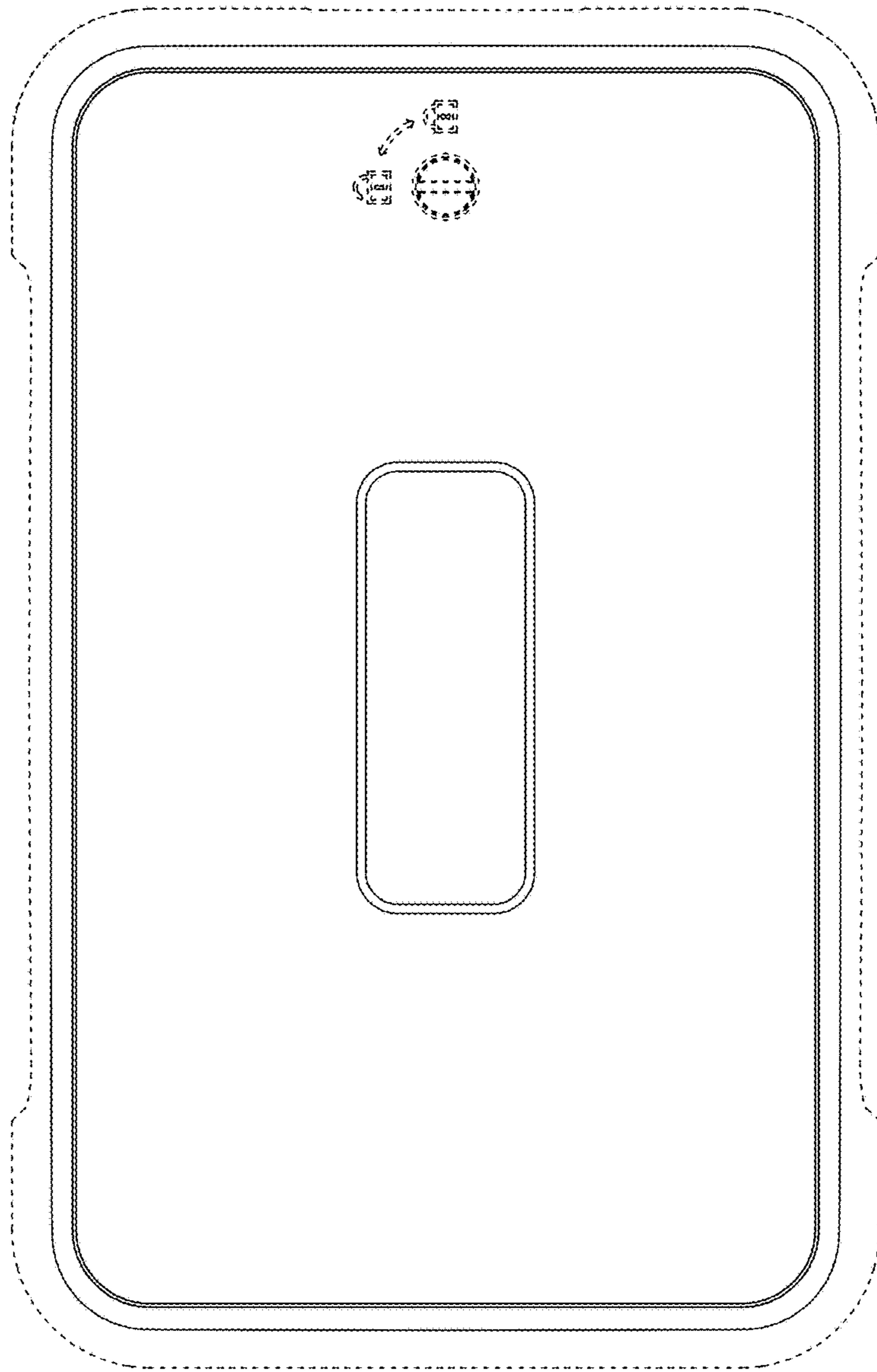

FIG. 2

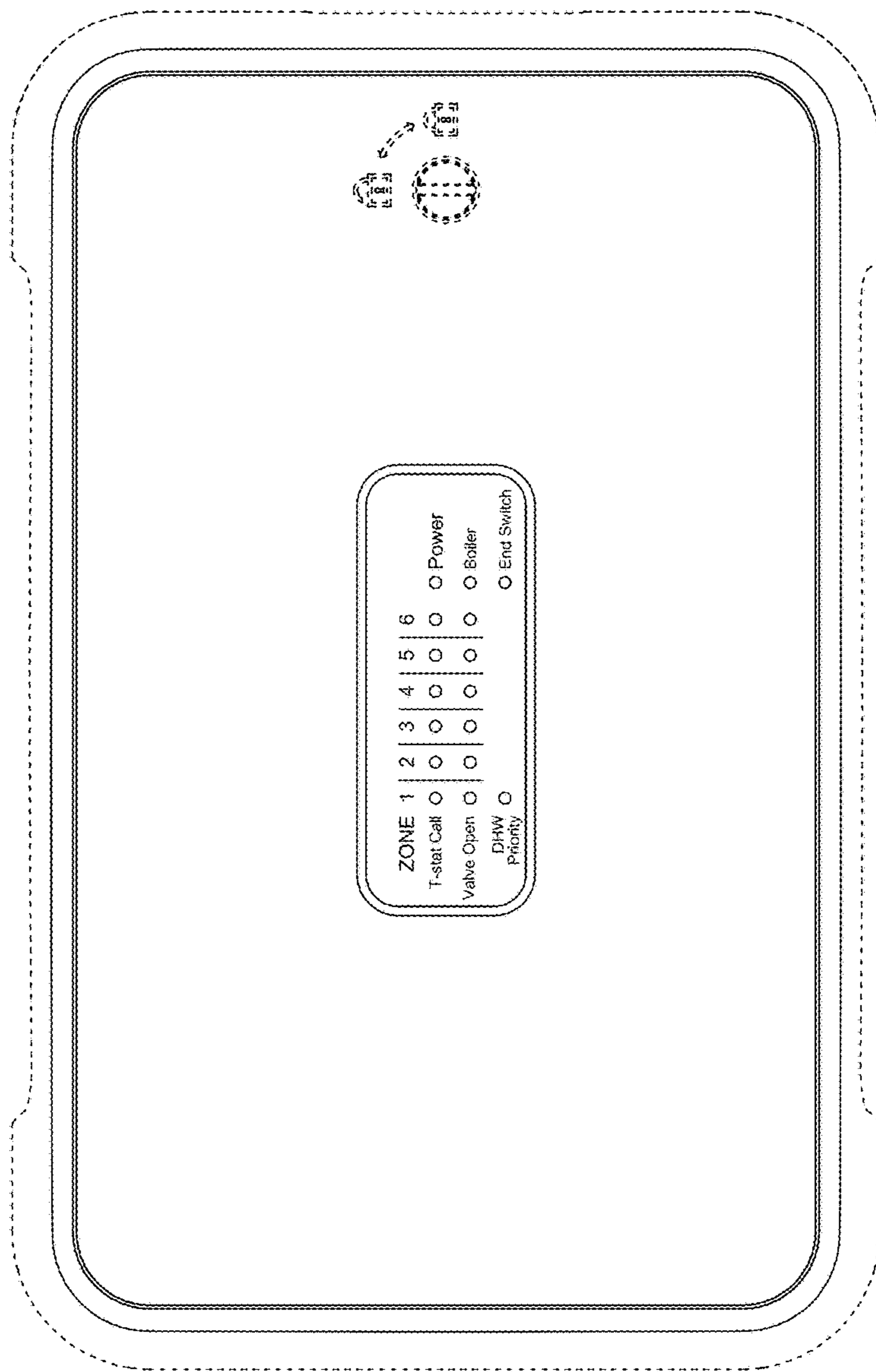

FIG. 3

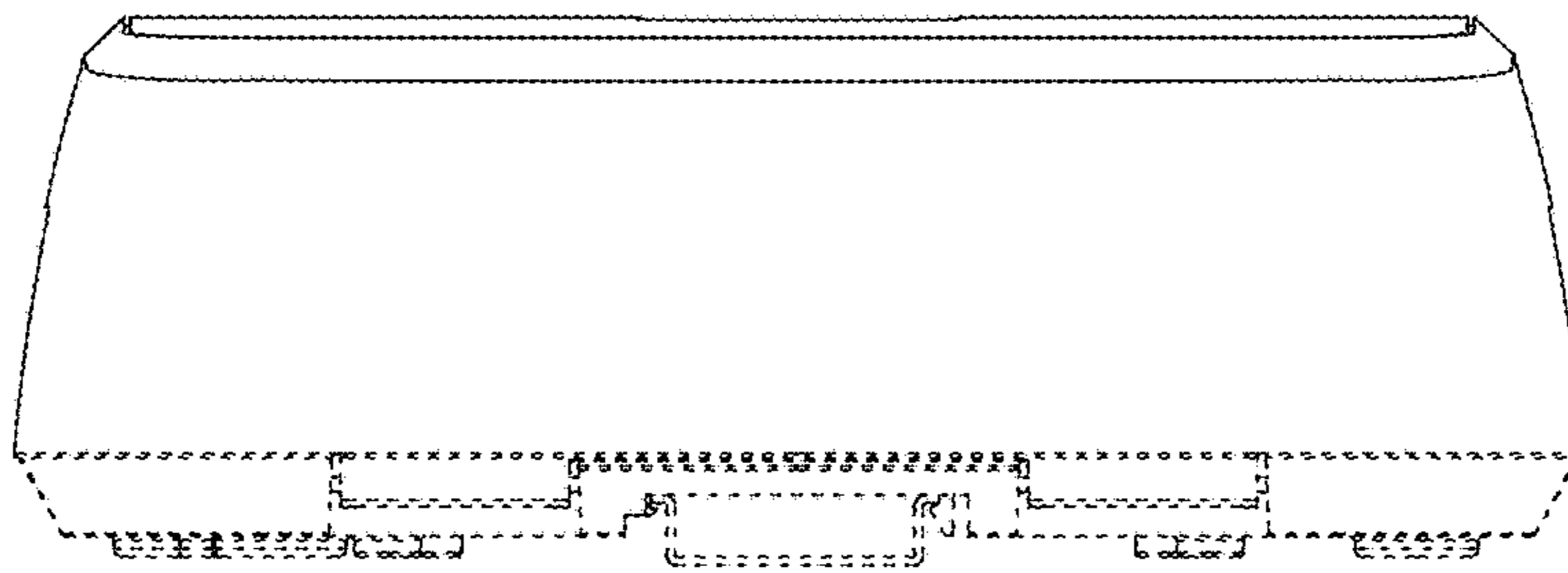

FIG. 4

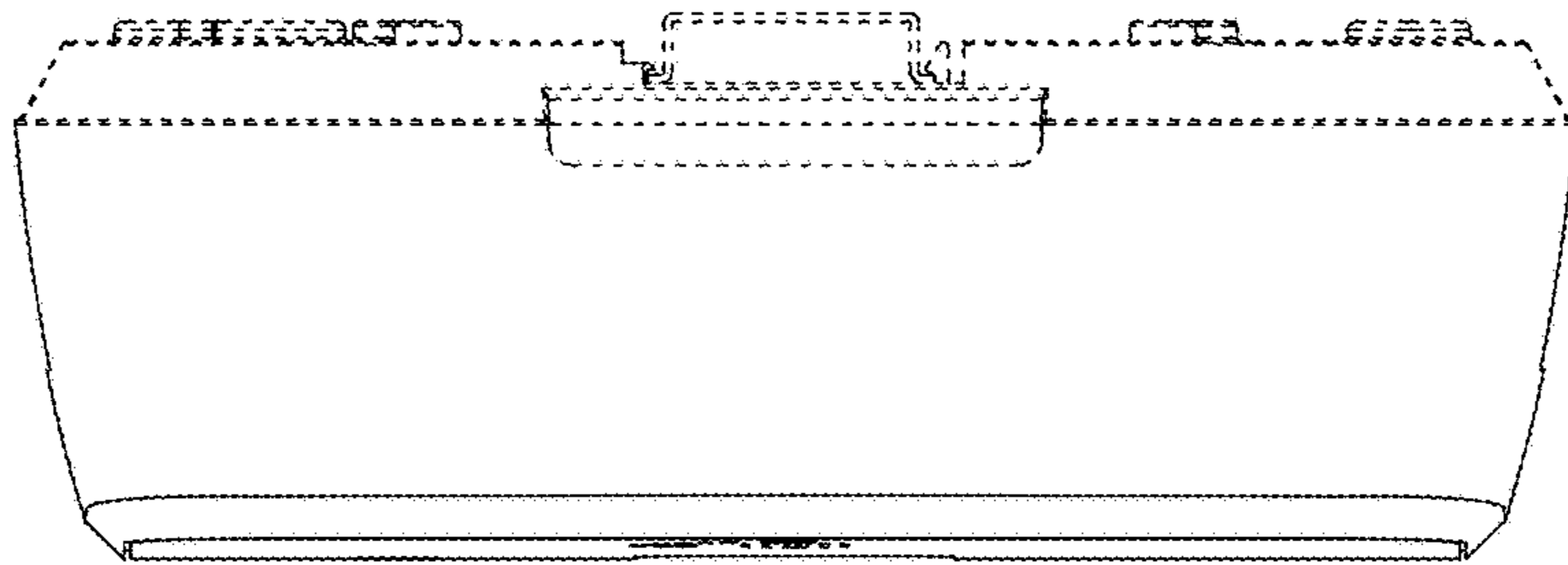

FIG. 5

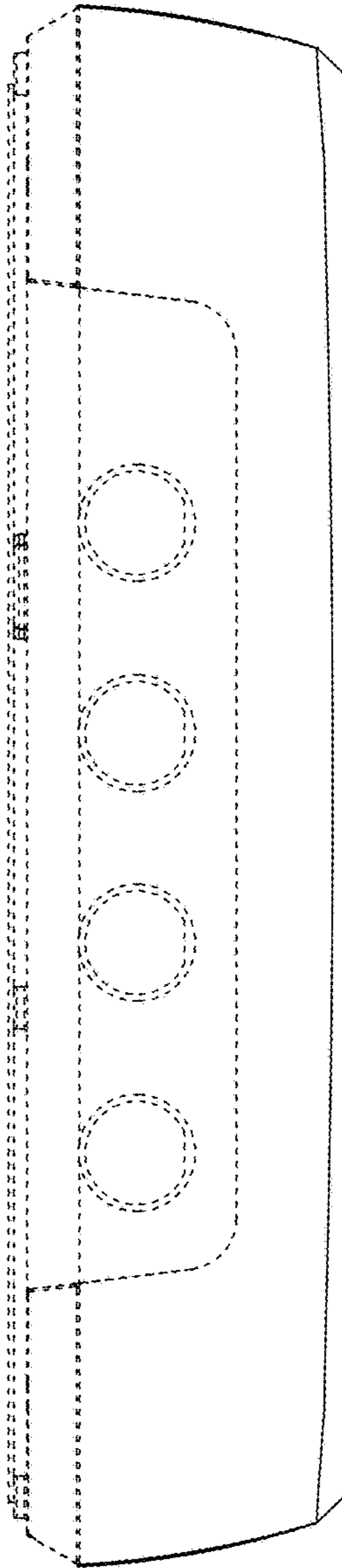

FIG. 6

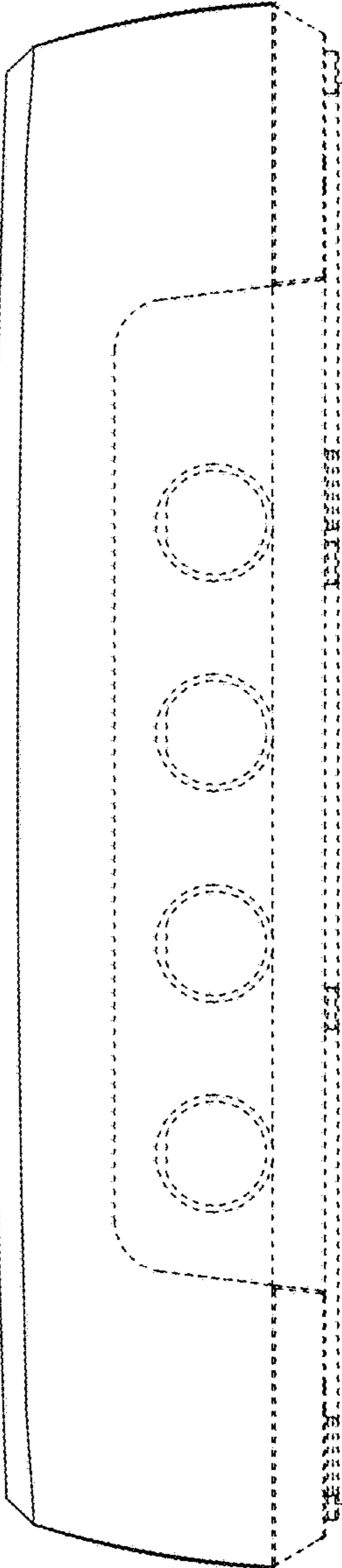

FIG. 7

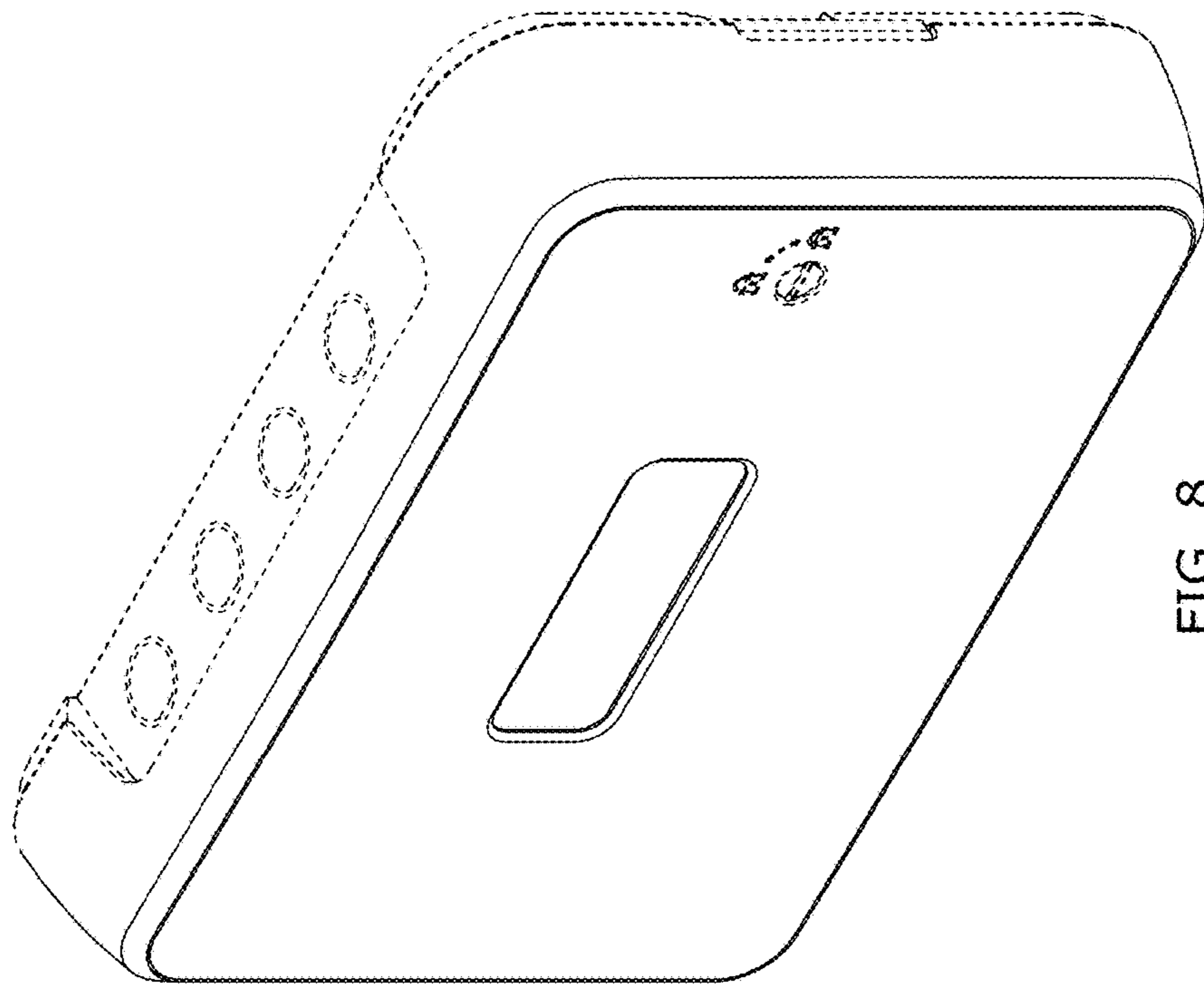

FIG. 8

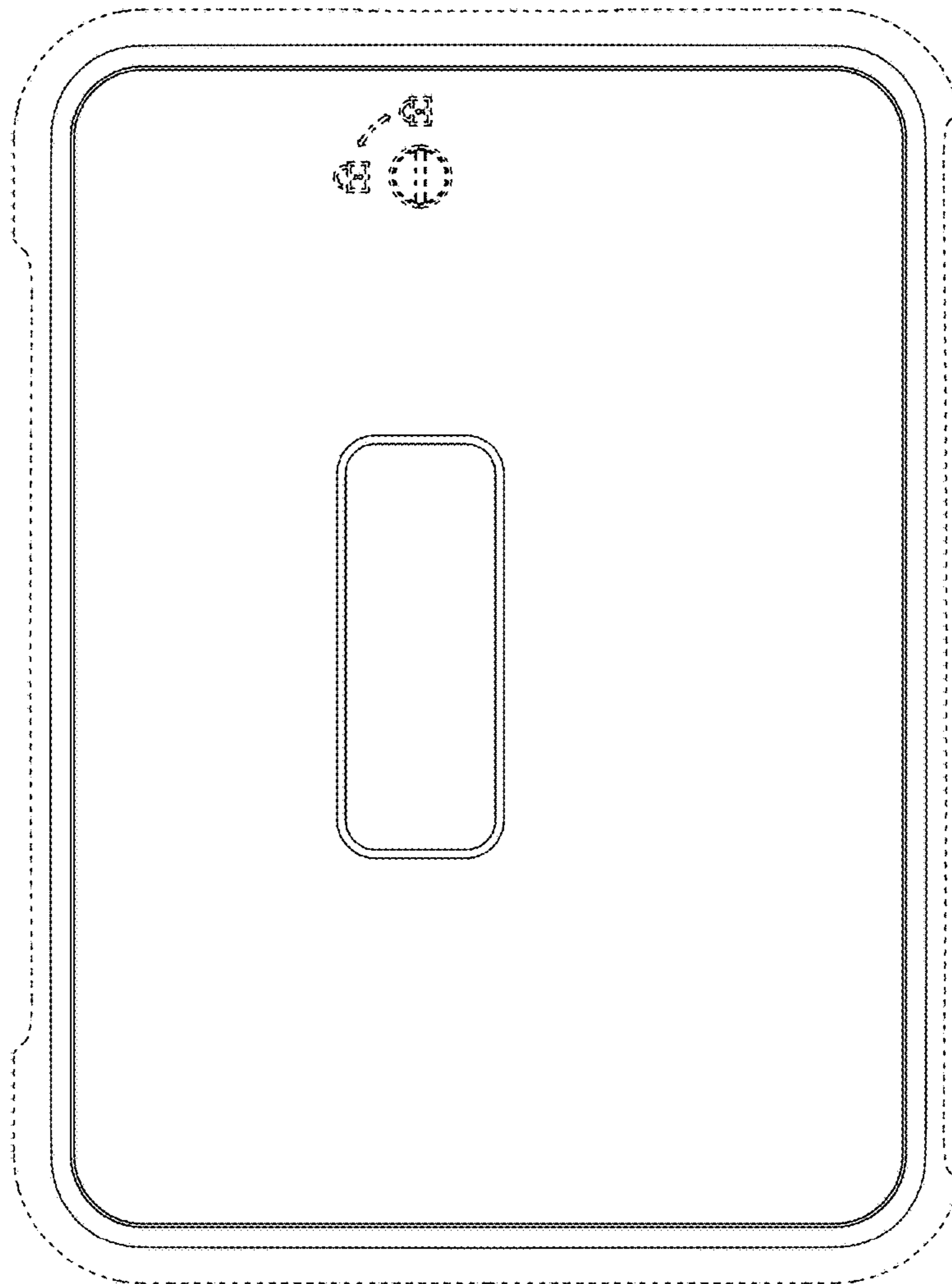

FIG. 9

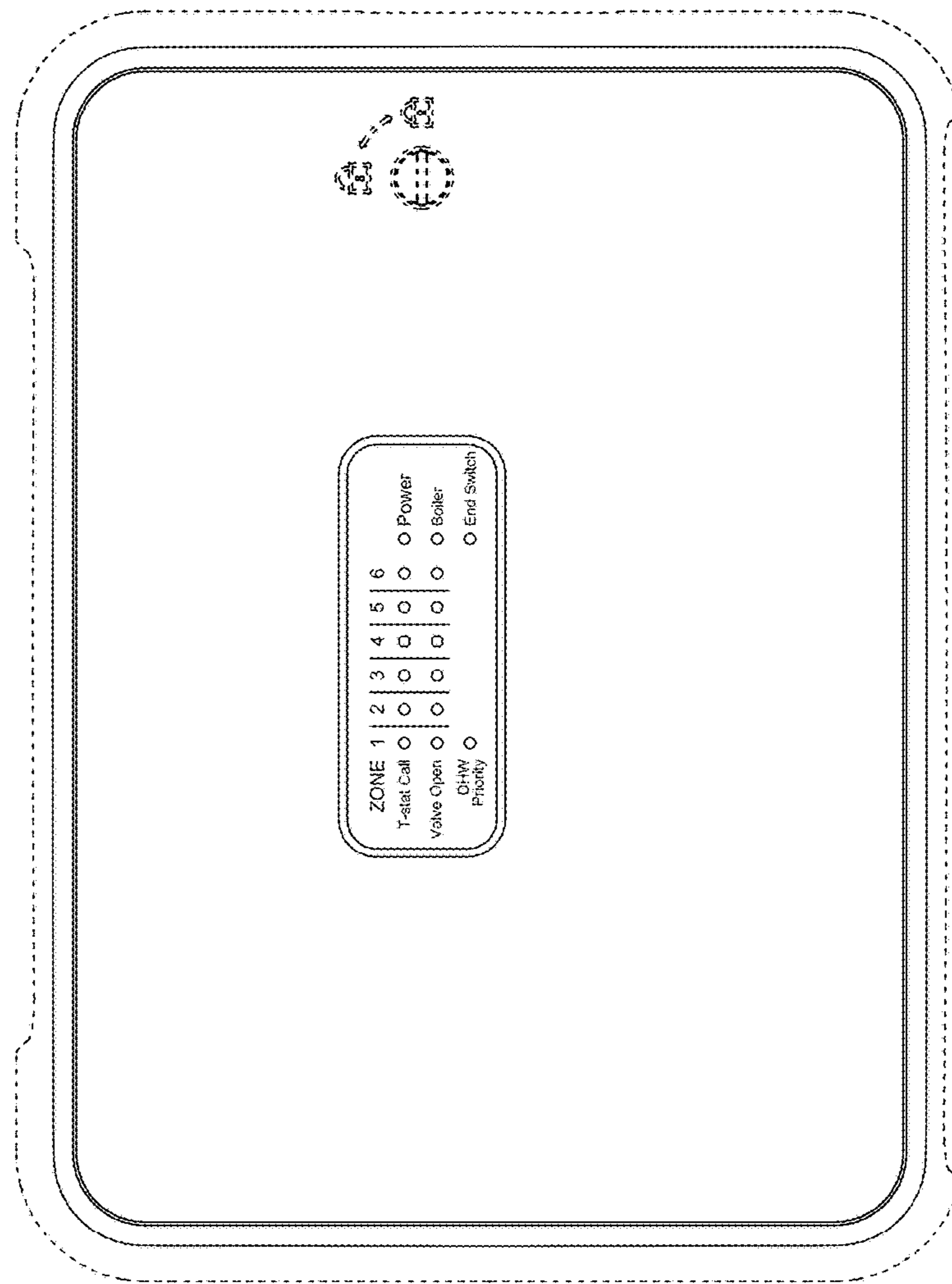

FIG. 10

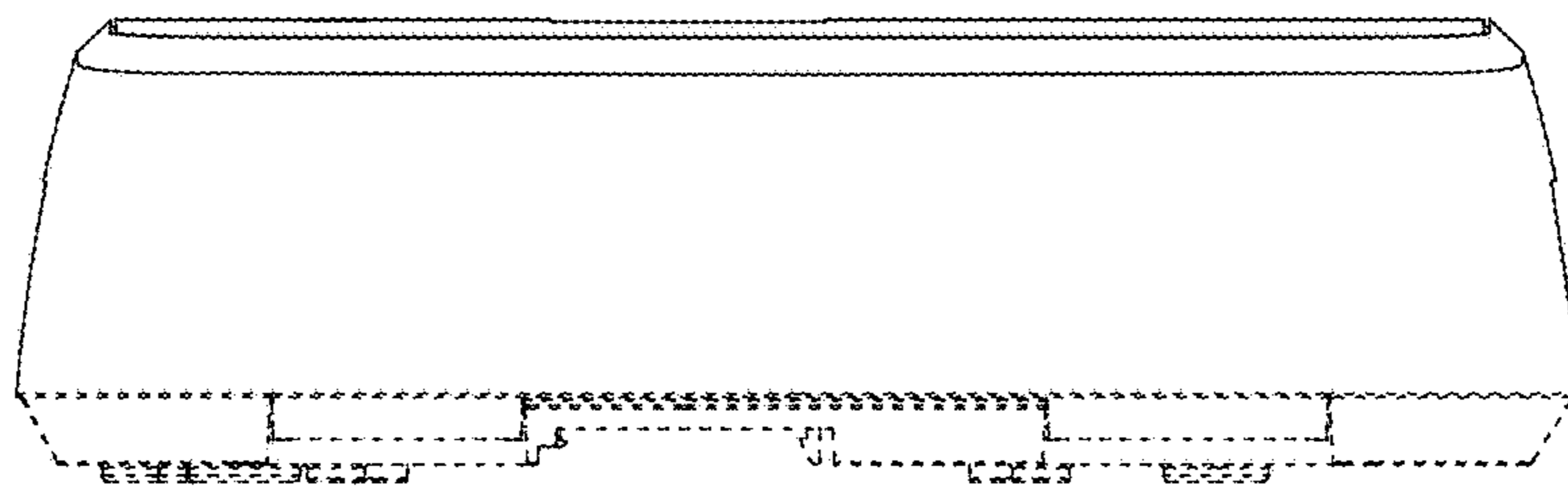

FIG. 11

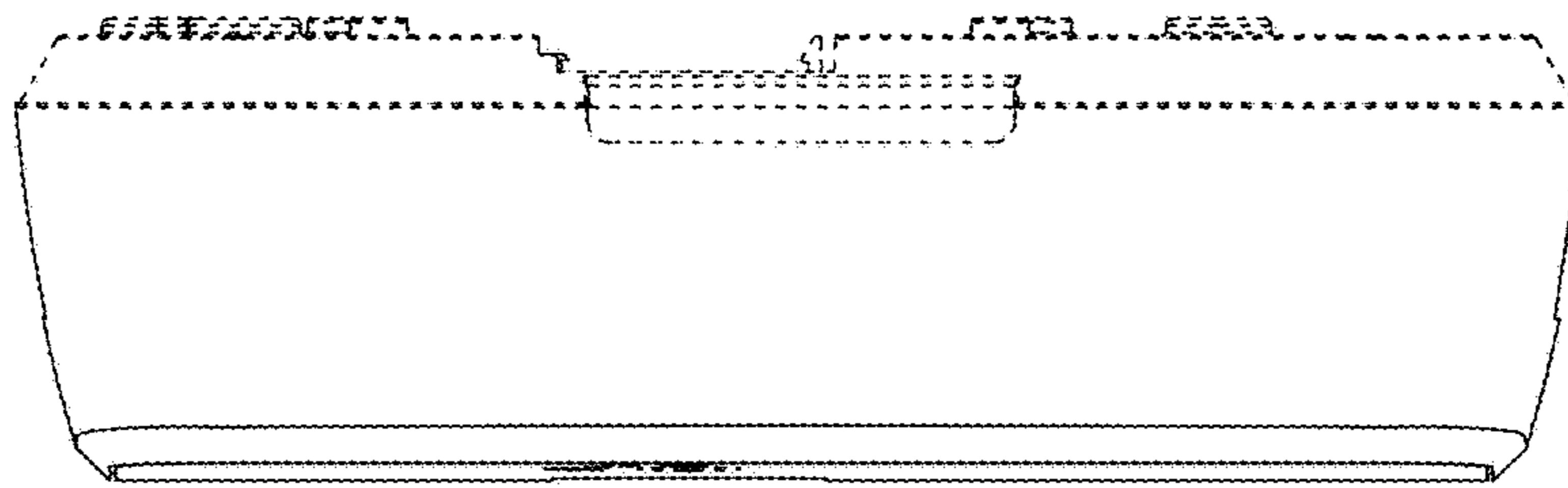

FIG. 12

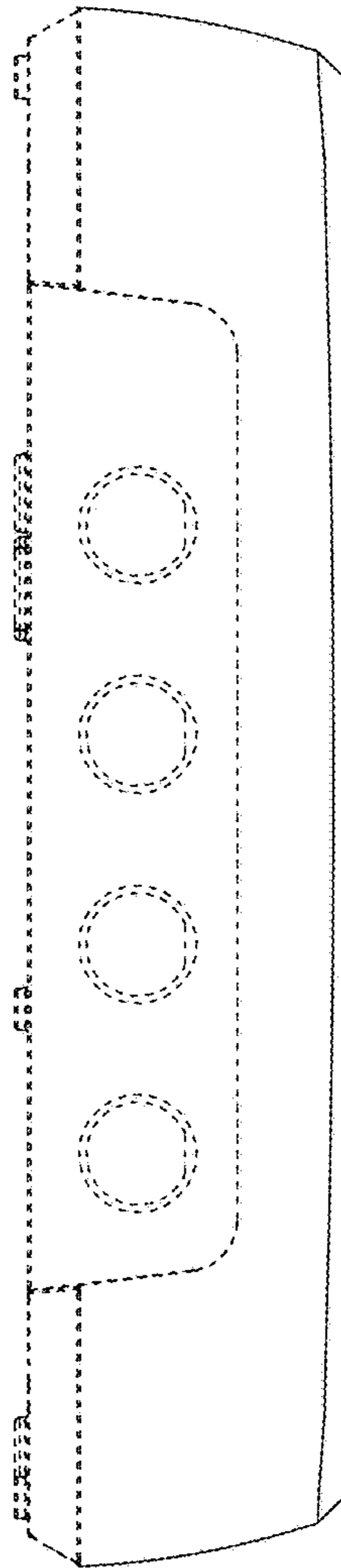

FIG. 13

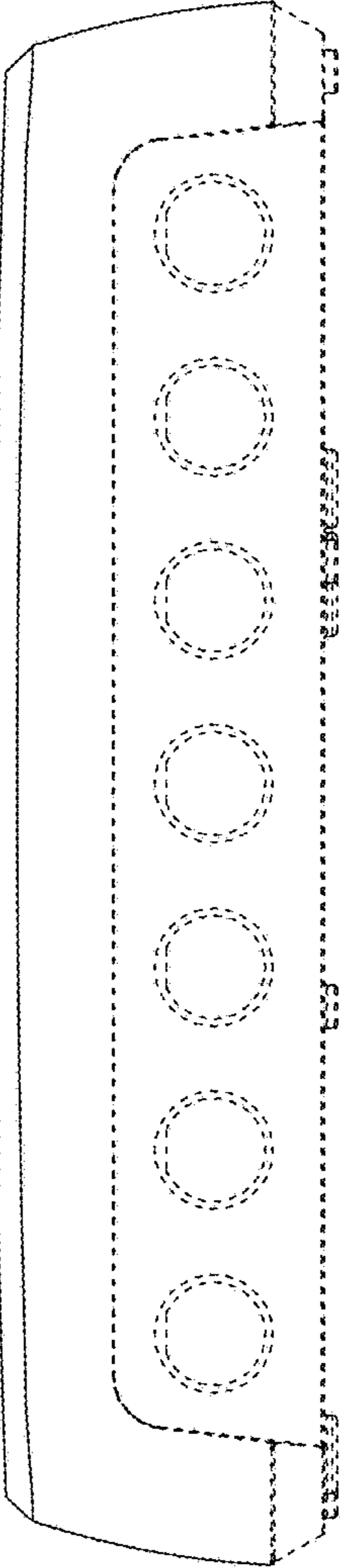

FIG. 14

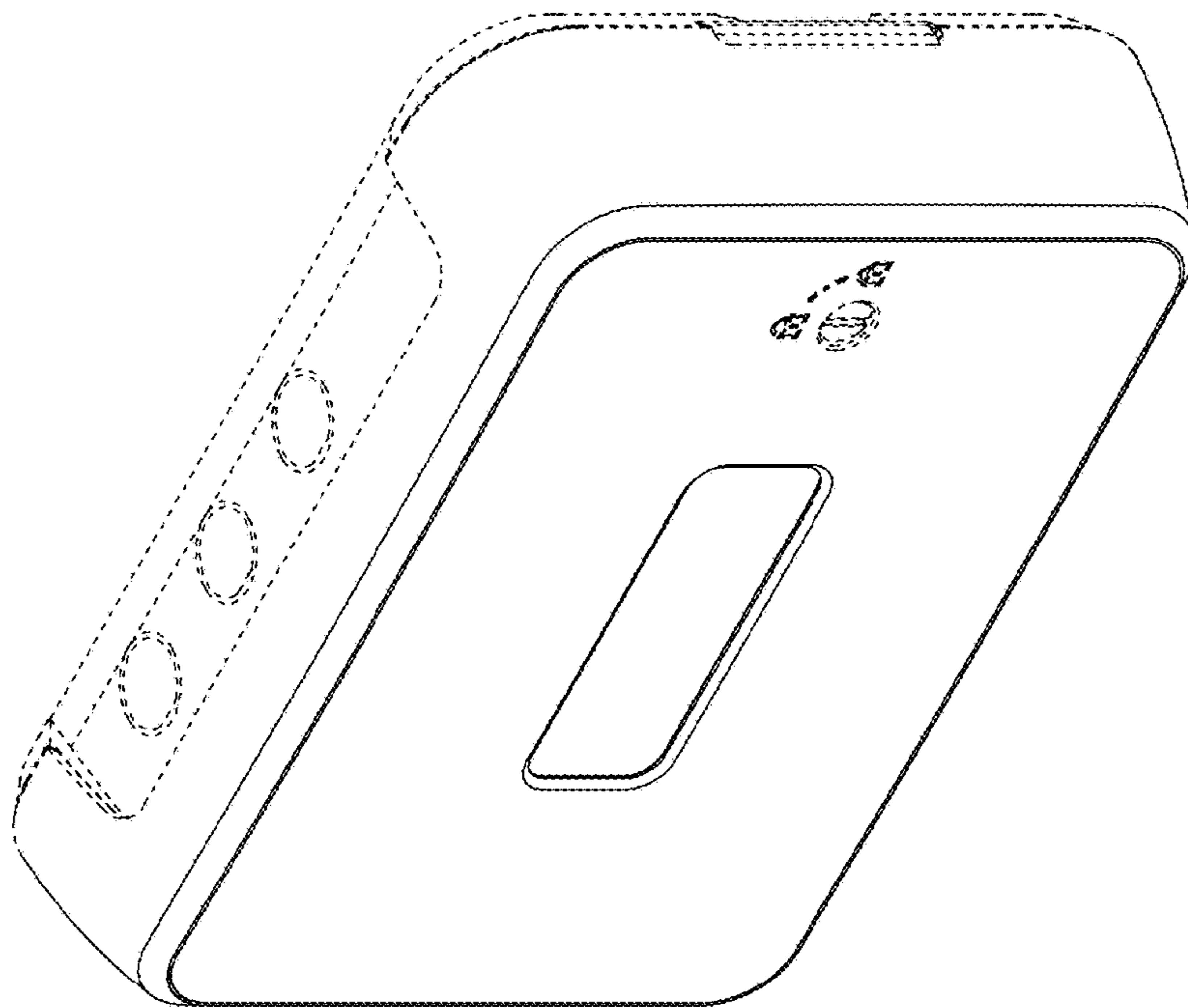

FIG. 15

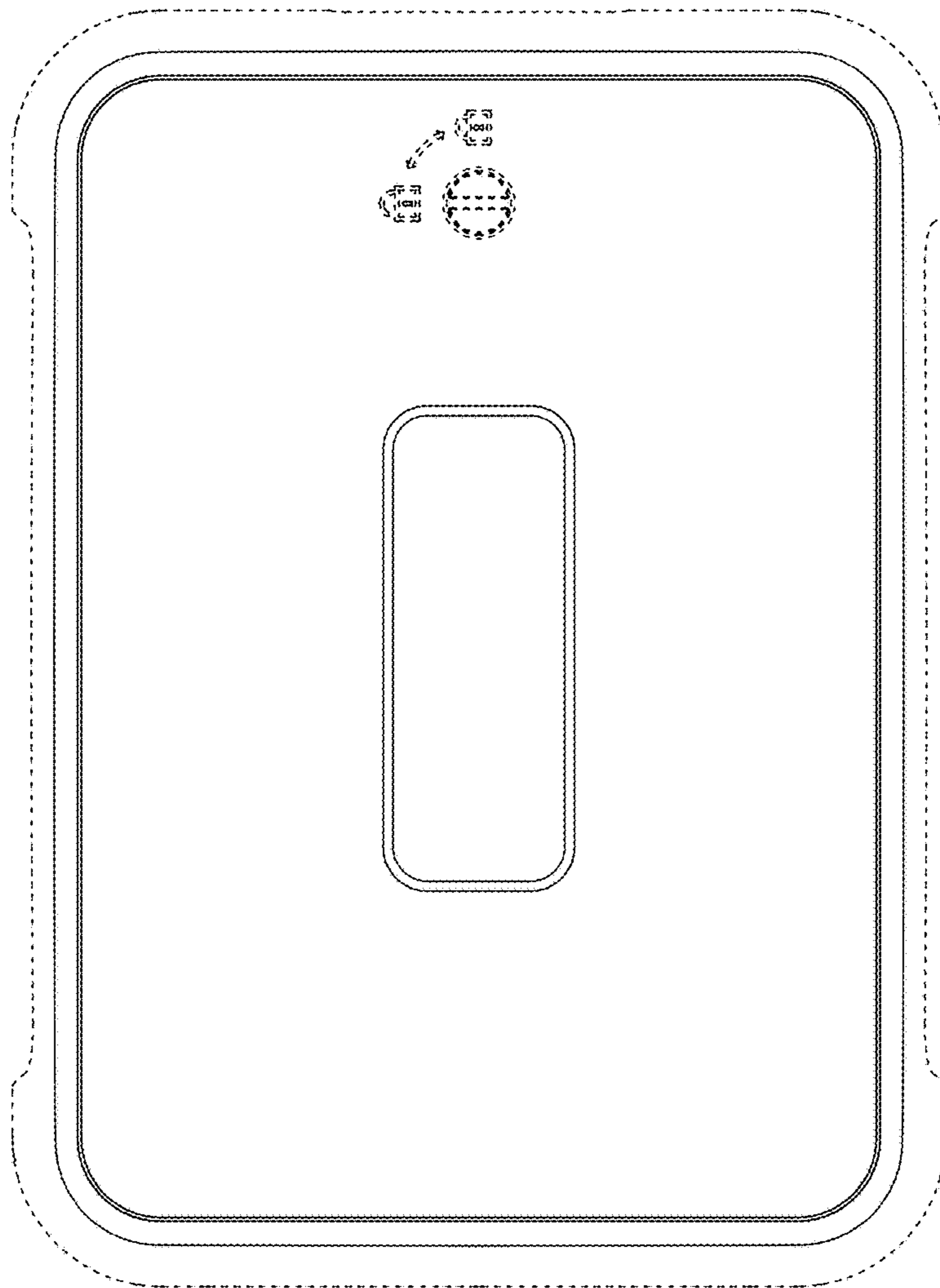

FIG. 16

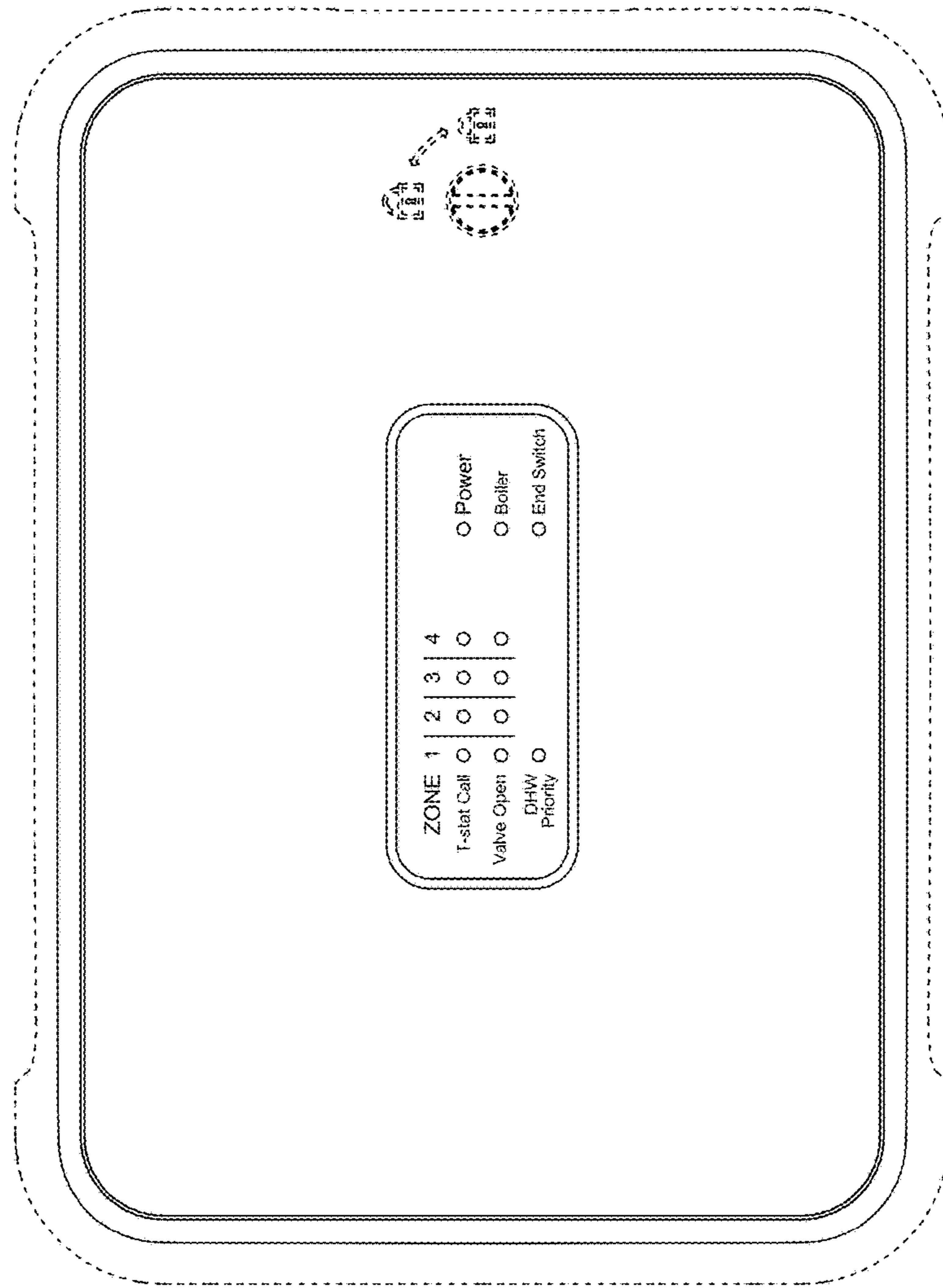

FIG. 17

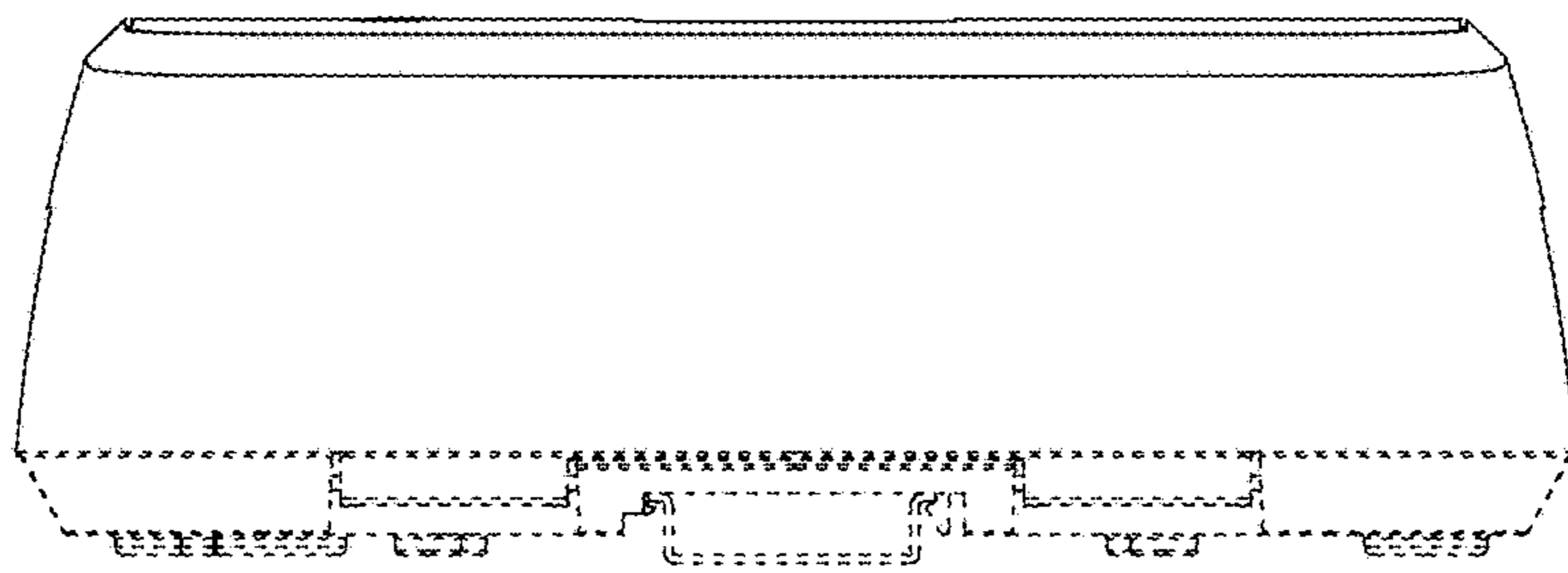

FIG. 18

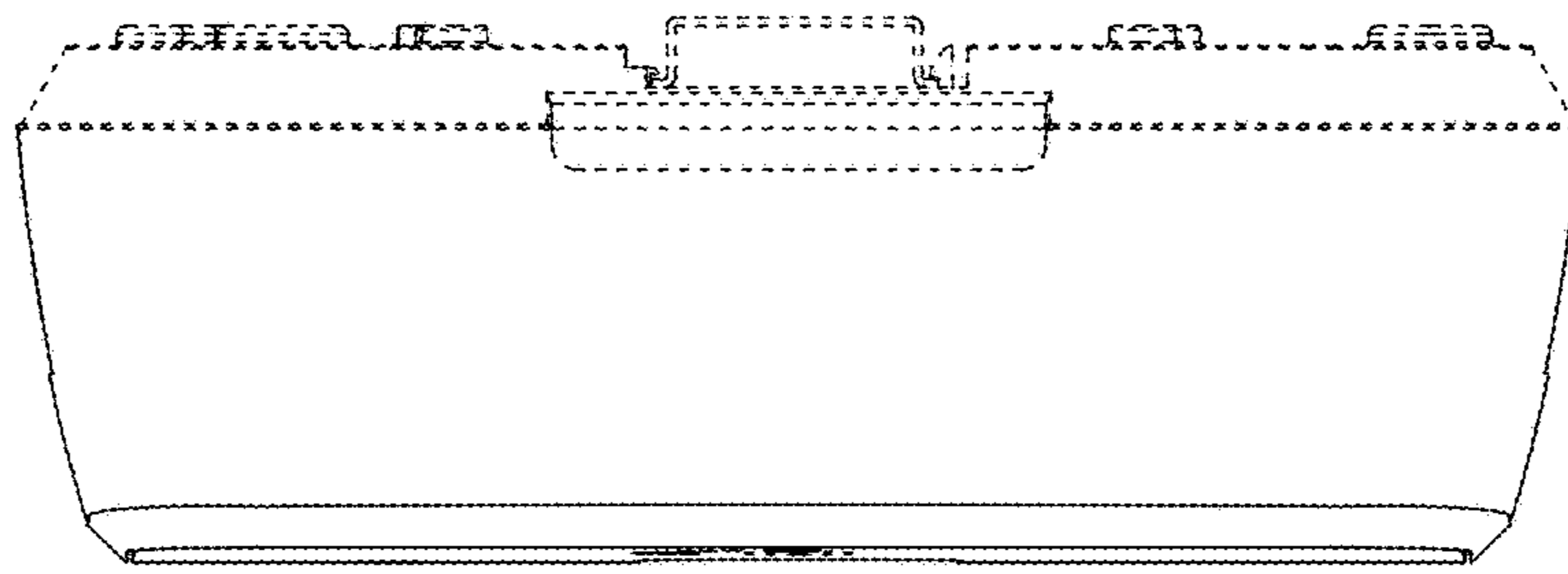

FIG. 19

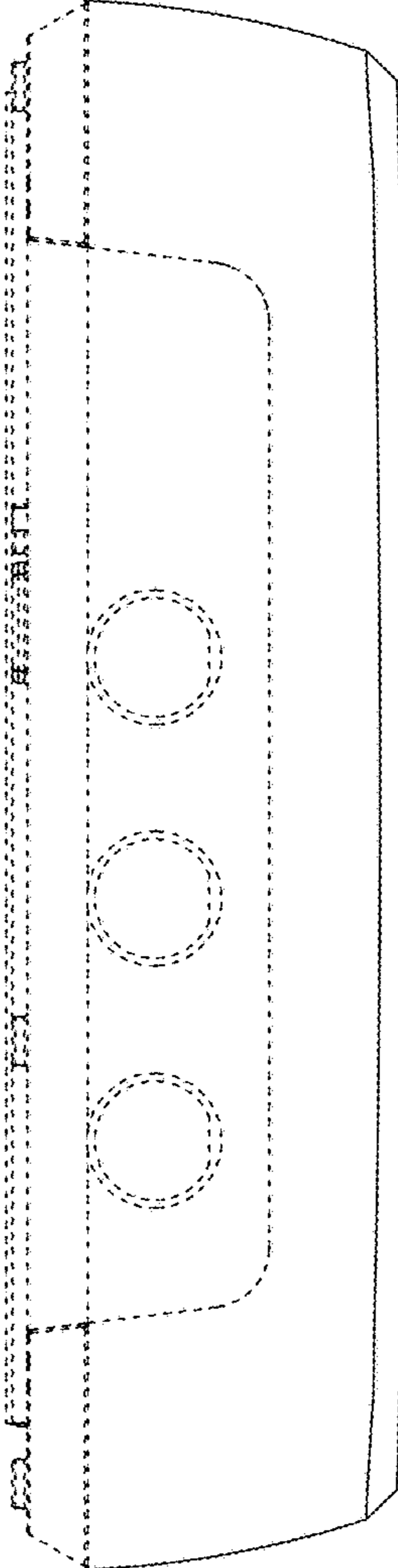

FIG. 20

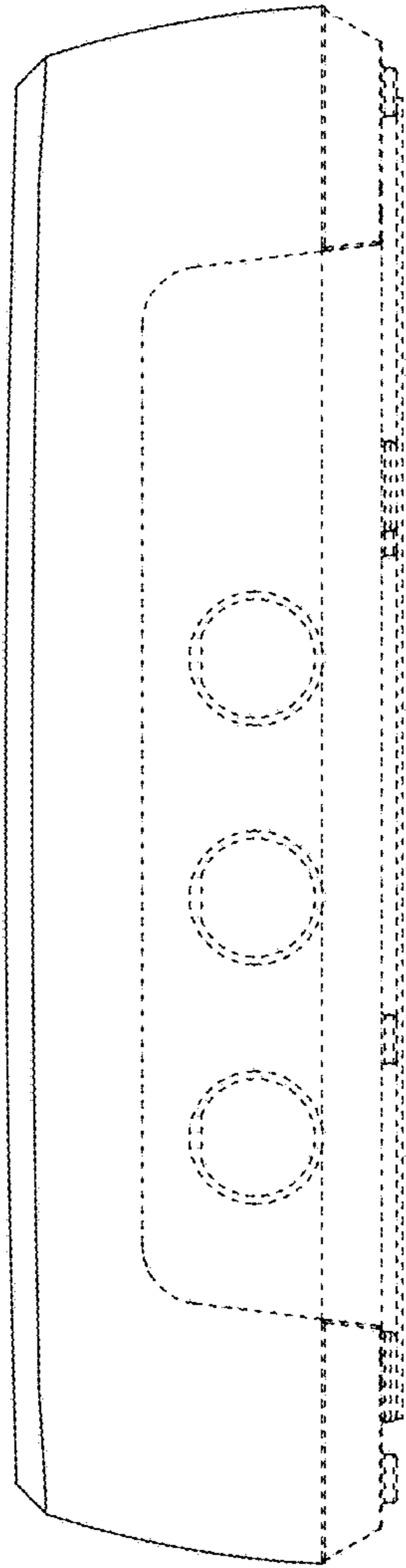

FIG. 21