



US00D862131S

(12) **United States Design Patent**
Faulk

(10) **Patent No.:** **US D862,131 S**

(45) **Date of Patent:** **** Oct. 8, 2019**

(54) **OUTDOOR KITCHEN CABINET**

(71) Applicant: **Kalamazoo Outdoor Gourmet, LLC**,
Chicago, IL (US)

(72) Inventor: **Russell Faulk**, Elmhurst, IL (US)

(73) Assignee: **KALAMAZOO OUTDOOR GOURMET, LLC**, Chicago, IL (US)

(**) Term: **15 Years**

(21) Appl. No.: **29/625,586**

(22) Filed: **Nov. 10, 2017**

(51) **LOC (12) Cl.** **06-04**

(52) **U.S. Cl.**
USPC **D6/663**

(58) **Field of Classification Search**

USPC D6/574, 657, 659, 660, 661, 662, 662.1,
D6/663, 671, 671.1-671.4, 672, 675,
D6/675.1, 675.2, 675.5, 678, 678.1,
D6/678.4, 679, 680.2, 683, 683.1, 703,
D6/705.5

CPC A47B 43/00; A47B 46/00; A47B 47/04;
A47B 47/05; A47B 47/024; A47B
47/042; A47B 49/006; A47B 67/04; A47B
81/002; A47B 87/00; A47B 87/002; A47B
87/008; A47B 87/0215; A47B 88/00;
A47B 88/48; A47B 88/57; A47B 88/75;
A47B 88/90; A47B 88/427; A47B
88/941; A47B 96/02; A47B 96/022; A47B
2210/19; A24F 25/02; A47F 3/0413;
A47F 5/116; A47F 5/0018; A47F 7/02;
A47F 9/00; B22F 3/1055; A01K 15/025;
A47K 3/281; E05B 17/2034;

(Continued)

(56) **References Cited**

U.S. PATENT DOCUMENTS

D146,861 S * 6/1947 Kneeland 108/25
D300,487 S * 4/1989 Dyer D34/19

(Continued)

Primary Examiner — Kevin K Rudzinski

Assistant Examiner — Paul D Bohannon

(74) *Attorney, Agent, or Firm* — Brinks Gilson & Lione

(57) **CLAIM**

I claim the ornamental design for an outdoor kitchen cabinet,
as shown and described.

DESCRIPTION

FIG. 1 is a perspective view of an outdoor kitchen cabinet
showing a first exemplary embodiment of our new design;

FIG. 2 is a front view thereof;

FIG. 3 is a rear view thereof;

FIG. 4 is a first side view thereof;

FIG. 5 is a second side view thereof;

FIG. 6 is a top view thereof;

FIG. 7 is a bottom view thereof;

FIG. 8 is a perspective view of the outdoor kitchen cabinet
with a countertop;

FIG. 9 is a perspective view of a pair of outdoor kitchen
cabinets arranged side-by-side with a countertop;

FIG. 10 is a perspective view of the outdoor kitchen cabinet
showing a second exemplary embodiment of our new
design;

FIG. 11 is a rear view thereof;

FIG. 12 is a first side view thereof;

FIG. 13 is a second side view thereof;

FIG. 14 is a top view thereof; and,

FIG. 15 is a bottom view thereof.

The horizontal line segments illustrated on the vertical
members that are arranged on both sides of the article and
the middle of the article, as can be clearly seen in FIGS. 1,
2, and 8-11, represent a first kind of surface material. The
wavy lines illustrated on panels of the article, as can be
clearly seen in FIGS. 1, 2, and 8-11, represent a second kind
of surface material different from the first material.

The broken lines shown in the drawings illustrate portions of
the article and form no part of the claimed design.

1 Claim, 7 Drawing Sheets

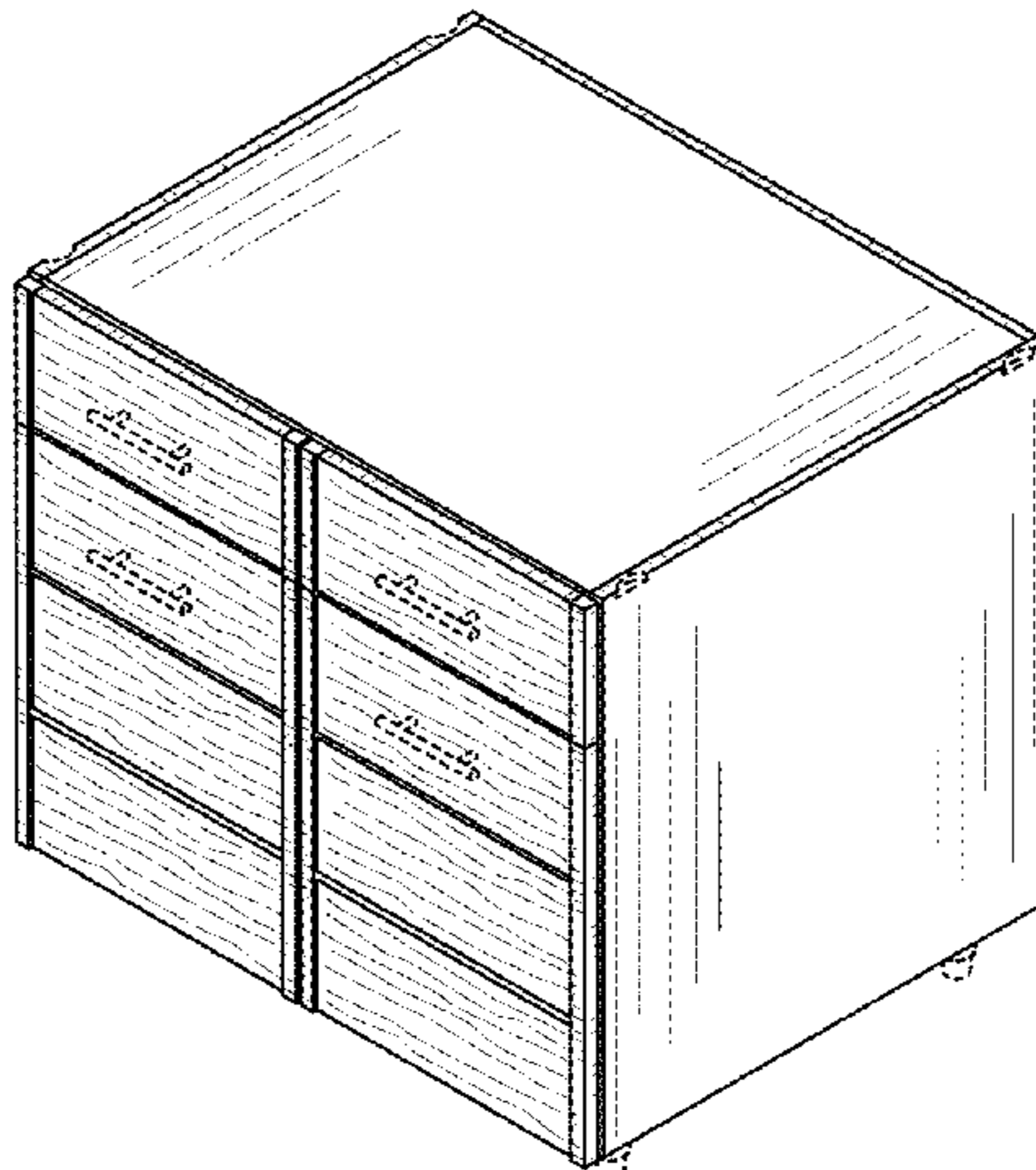

(58) **Field of Classification Search**

CPC E05B 65/463; E06B 3/7001; F25D 21/14;
 F25D 23/069; F25D 2400/10; G09B
 25/00; H02B 1/013; H02B 1/013014;
 H02B 1/013308; Y10T 428/4694

See application file for complete search history.

(56) **References Cited**

U.S. PATENT DOCUMENTS

D341,502	S	*	11/1993	Ball	D6/671.1
D346,288	S	*	4/1994	Black	D6/671.1
D364,517	S	*	11/1995	Martinez	D6/675
D383,331	S	*	9/1997	Bergelin	D6/671.1
D384,223	S	*	9/1997	Palka	D6/671
D424,832	S	*	5/2000	Lacroix	D6/671.1
D473,401	S	*	4/2003	de Blois	D6/671.1
D476,505	S	*	7/2003	Lenger	D6/671.1
D498,610	S	*	11/2004	Davis	D6/667
D498,945	S	*	11/2004	McDaniel	D6/671.2
D502,025	S	*	2/2005	McDaniel	D6/671.1
D550,004	S	*	9/2007	Gaska	D6/705.5
7,370,890	B2	*	5/2008	Samsel	E05B 53/001 292/162
D654,721	S	*	2/2012	Sexton	D6/671.1
D654,722	S	*	2/2012	Sexton	D6/671.1
D734,072	S	*	7/2015	Zhao	D6/671.1
D759,995	S	*	6/2016	Miller	D6/668.2
D763,604	S	*	8/2016	Weatherly	D6/671.1
D792,132	S	*	7/2017	Peota	D6/675
D821,457	S	*	6/2018	Kim	D15/79

* cited by examiner

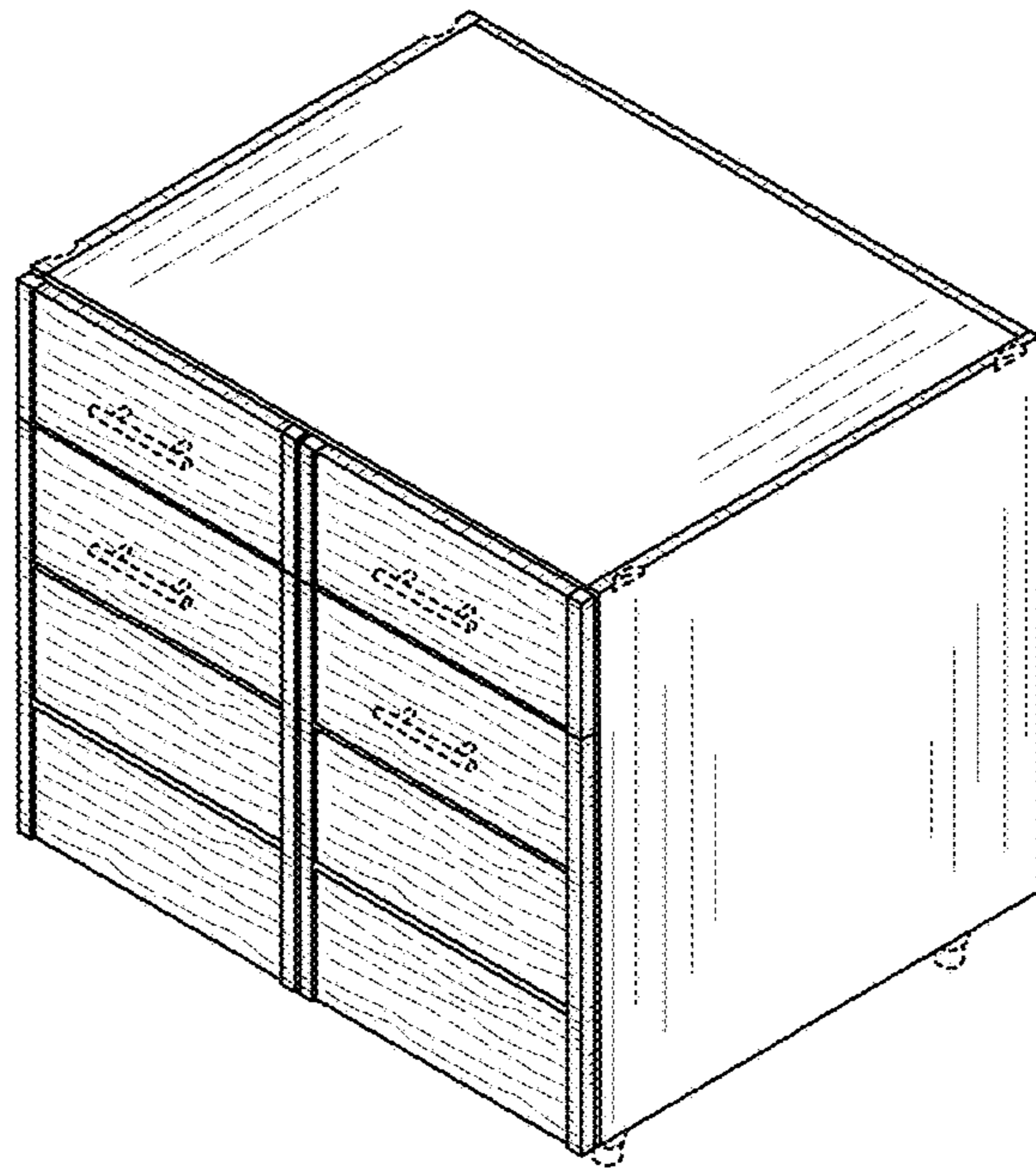

Fig. 1

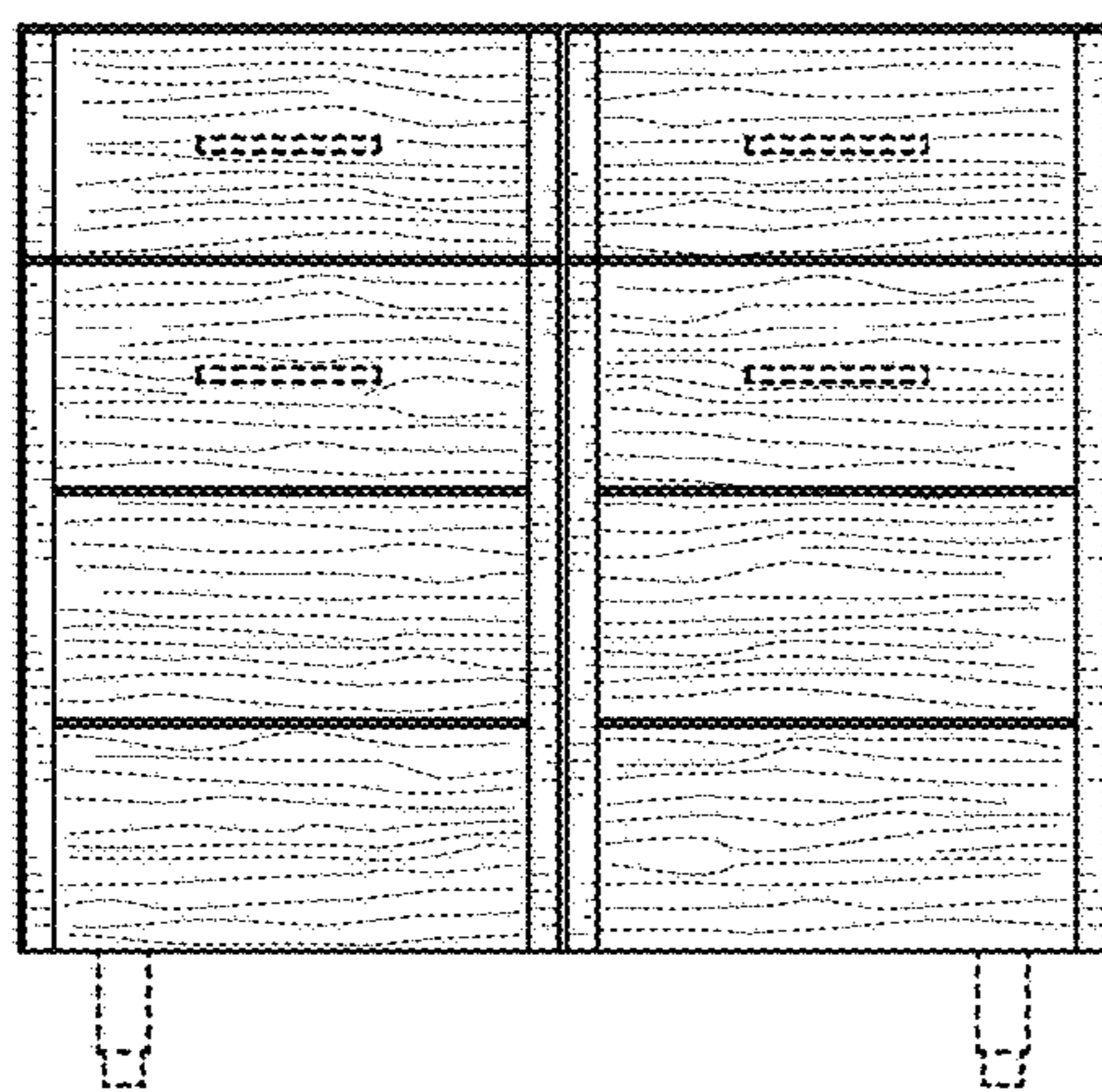

Fig. 2

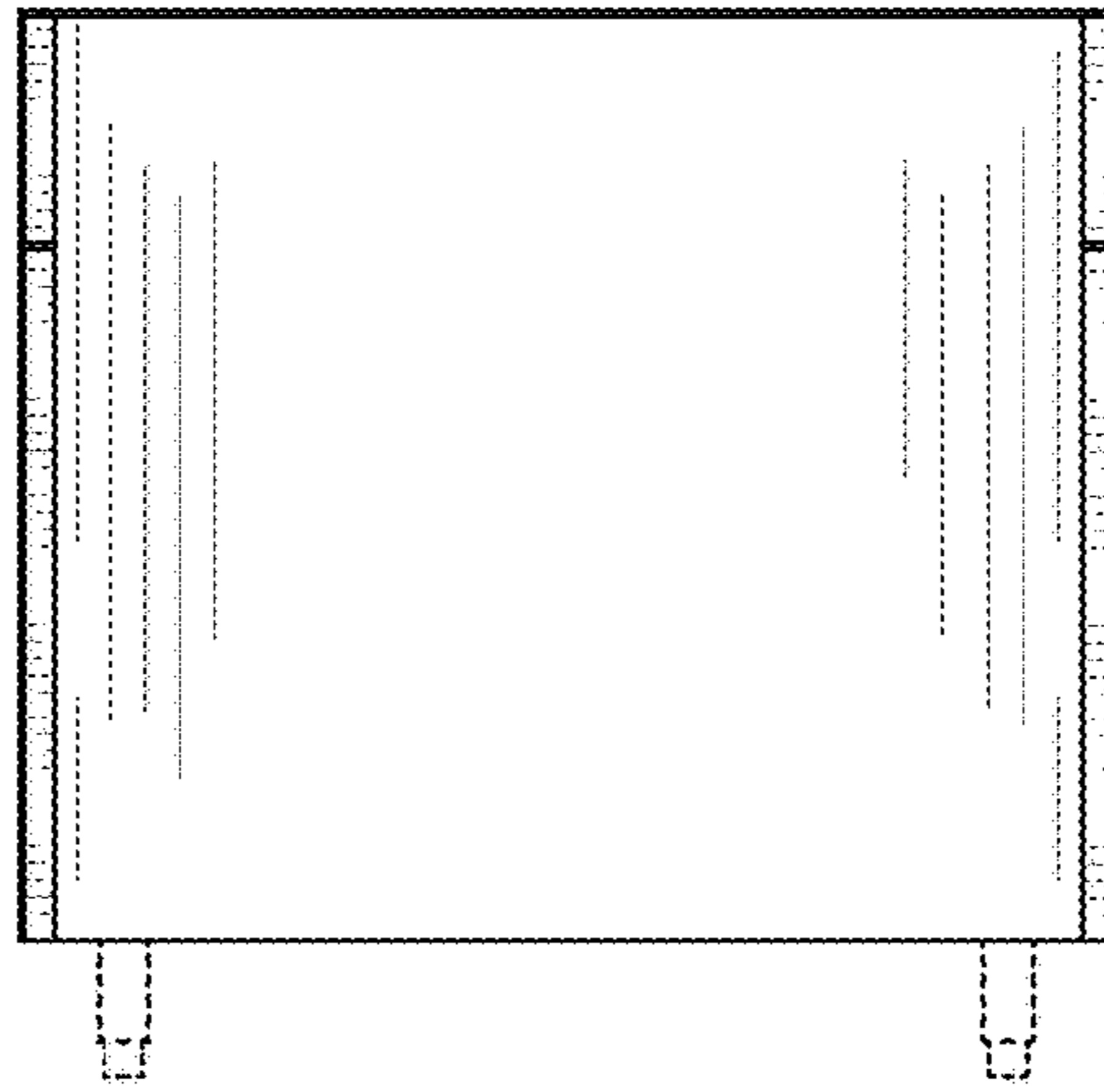

Fig. 3

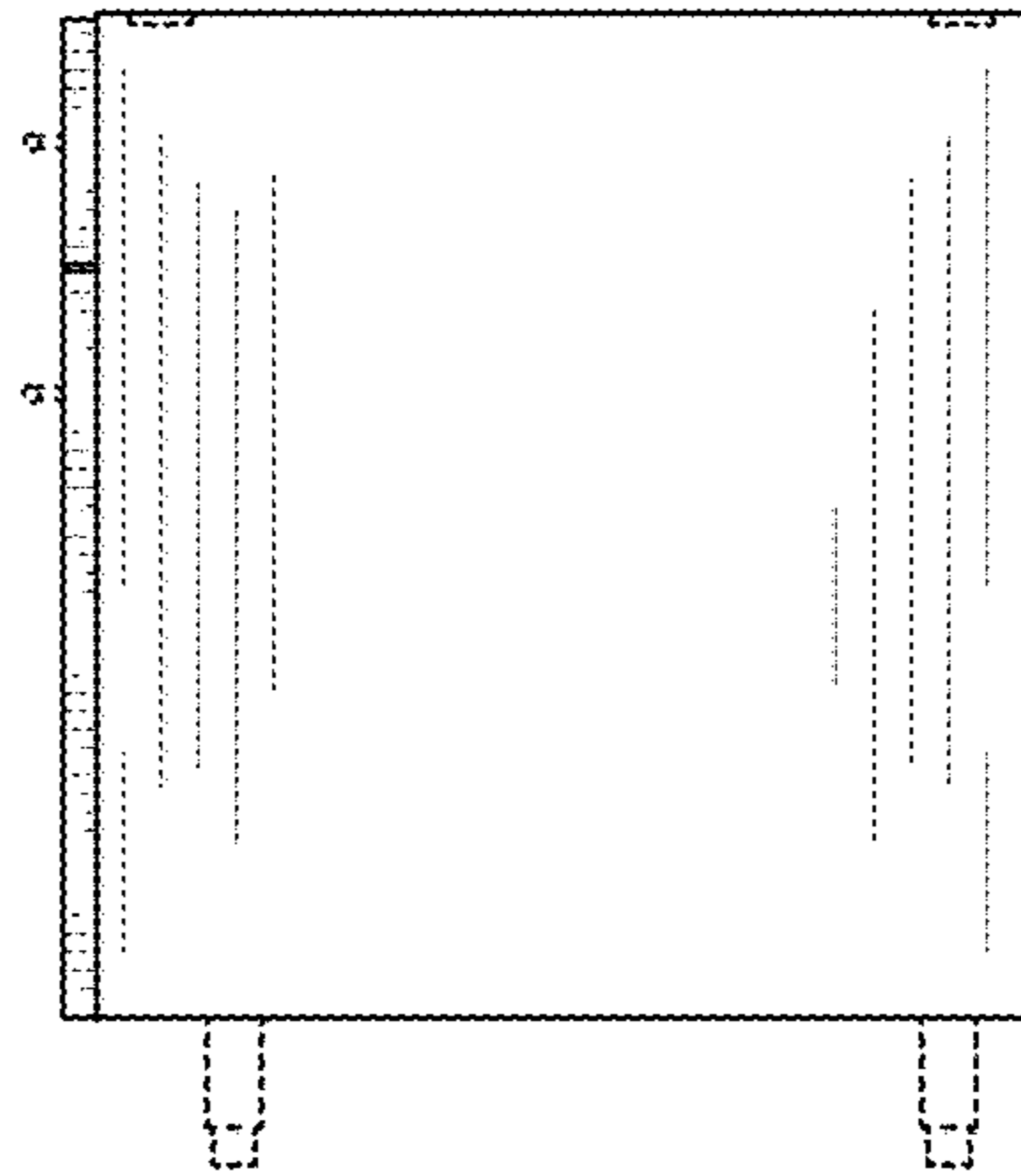

Fig. 4

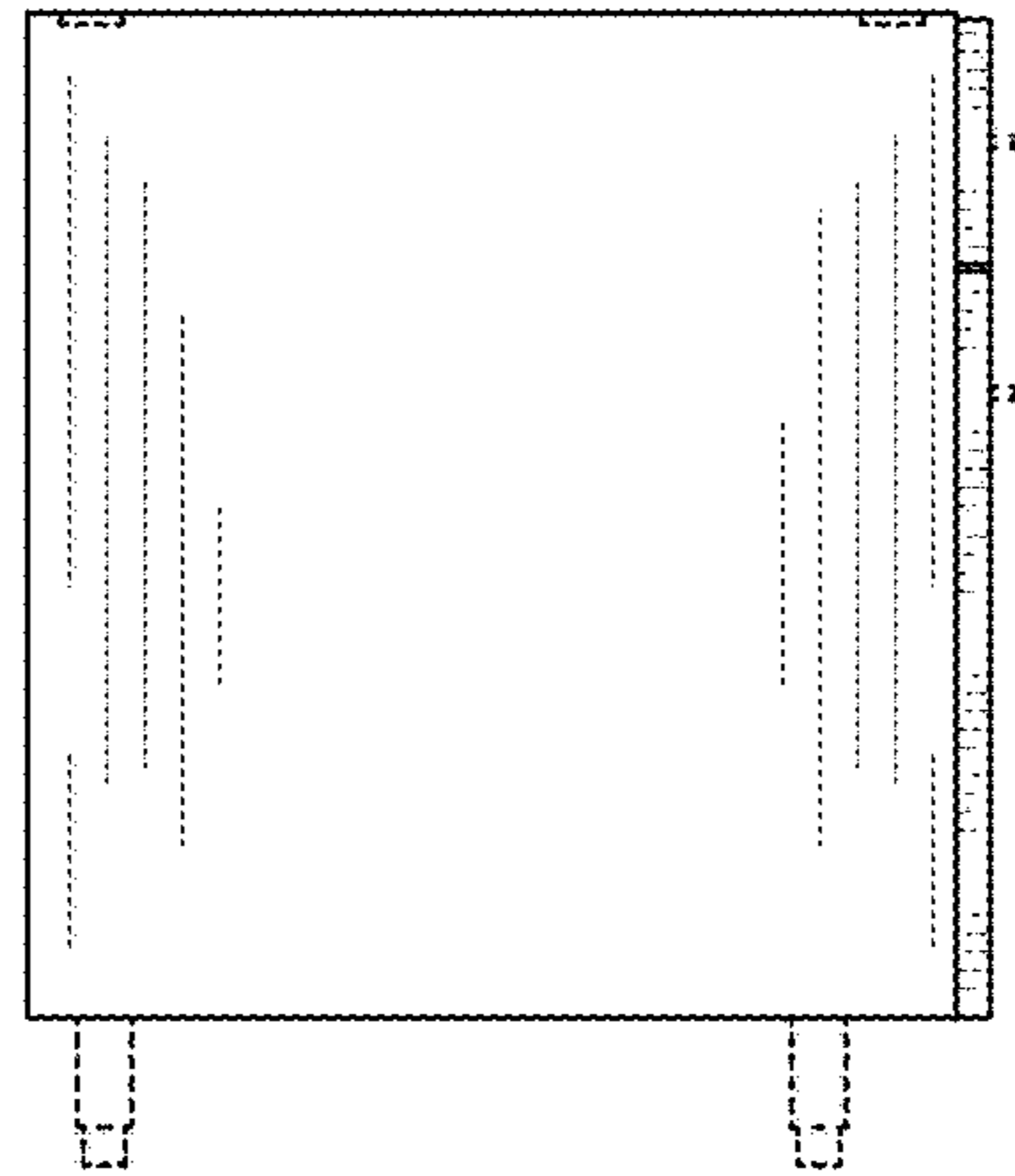

Fig. 5

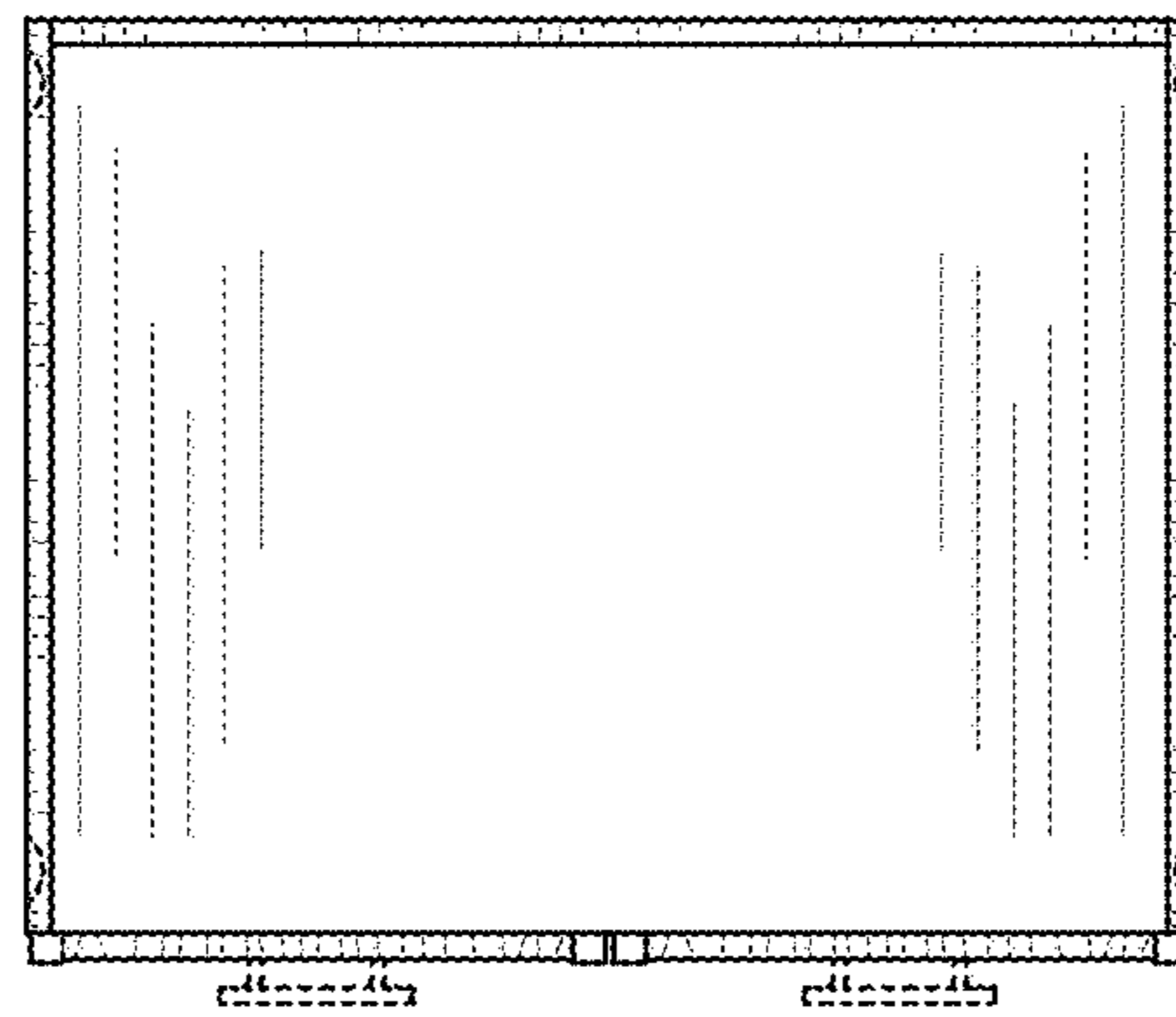

Fig. 6

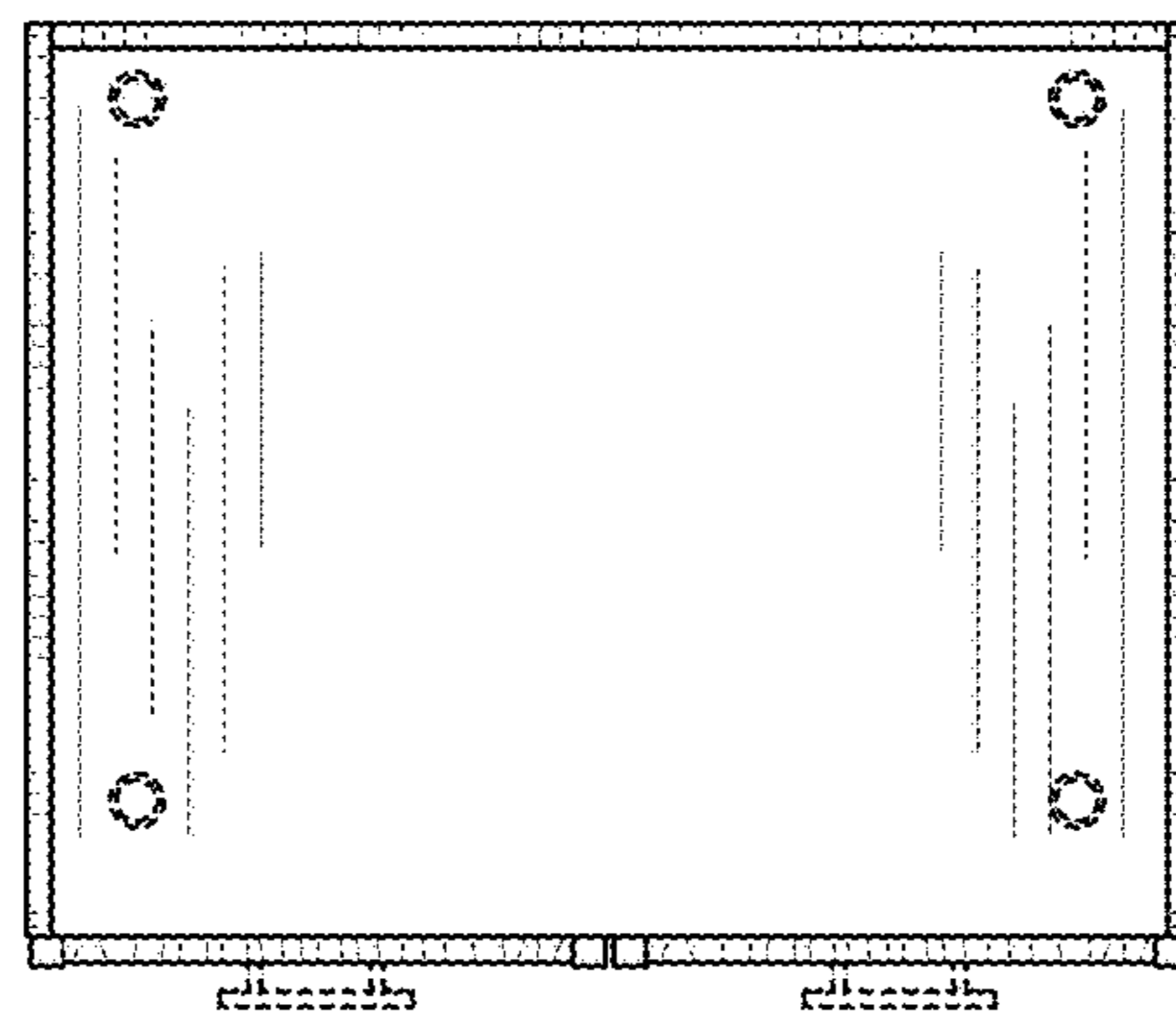

Fig. 7

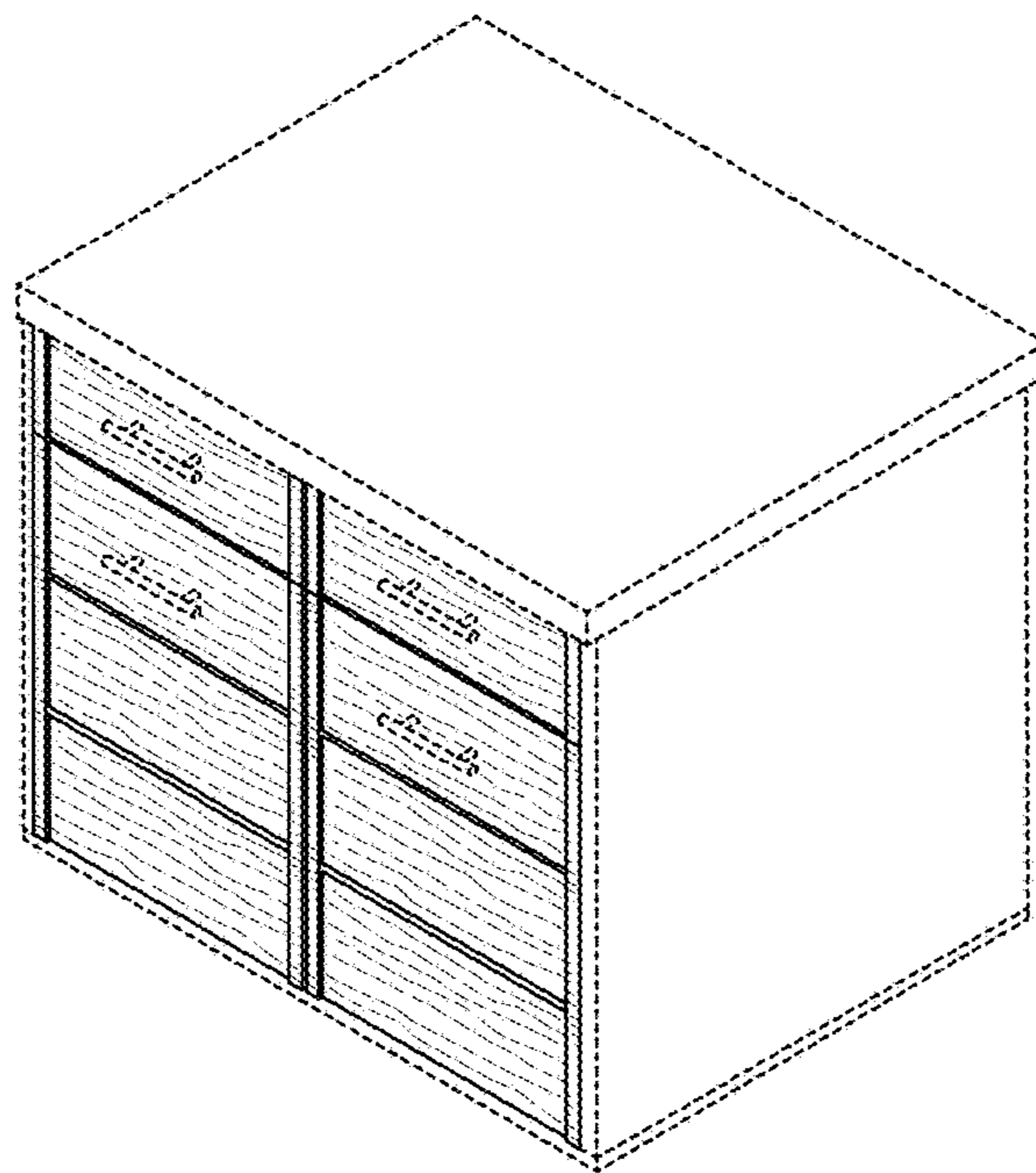

Fig. 8

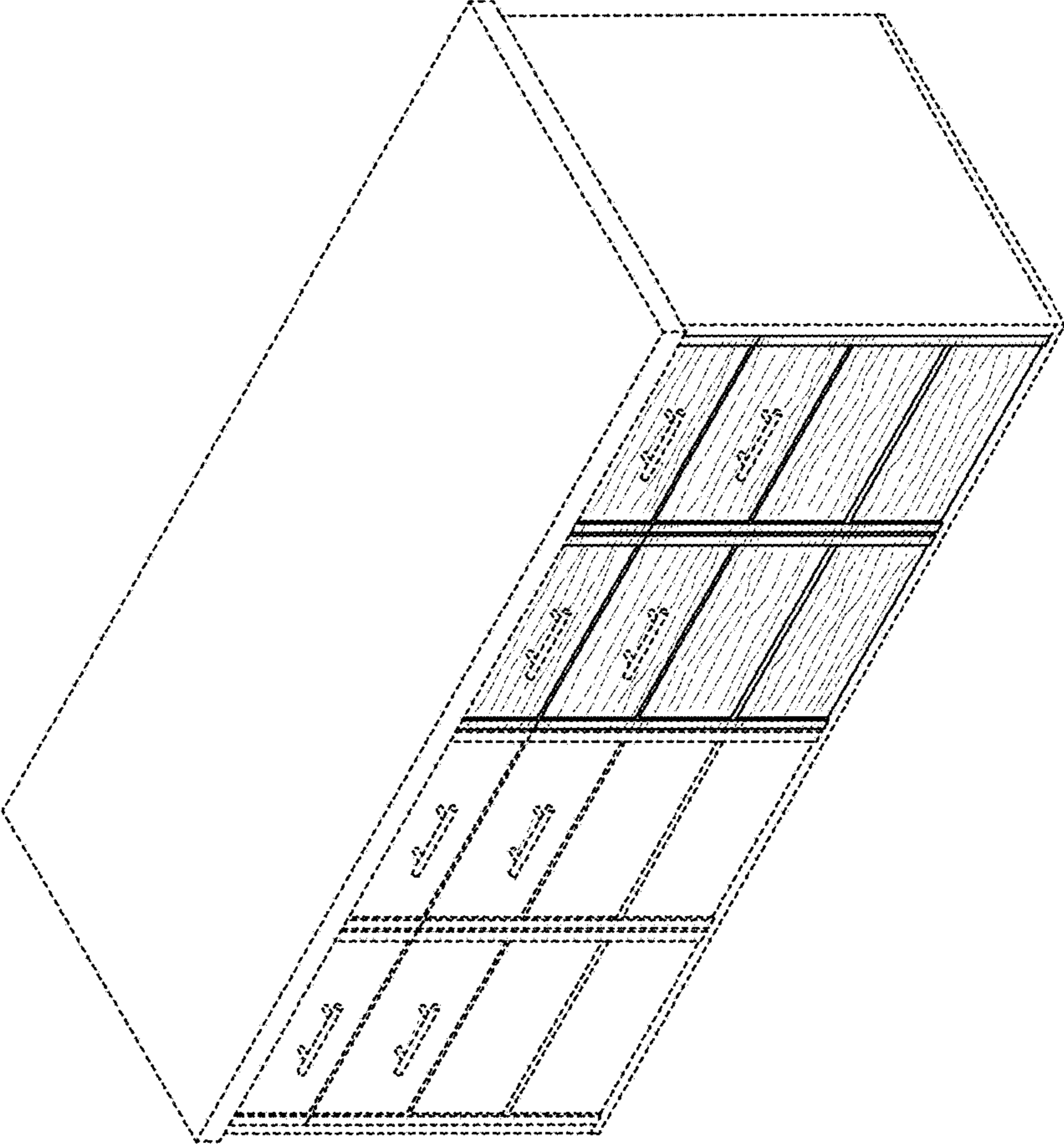

Fig. 9

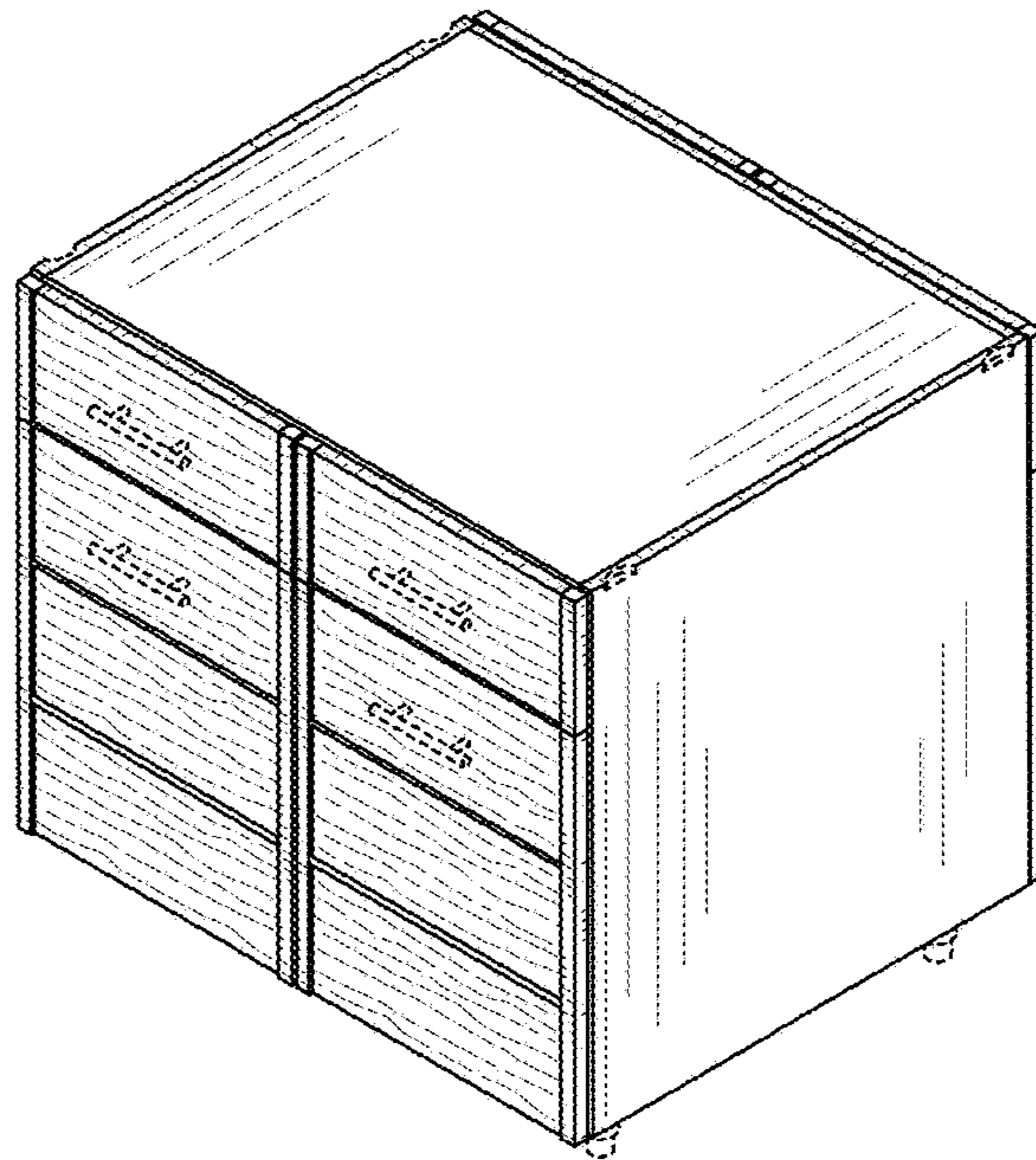

Fig. 10

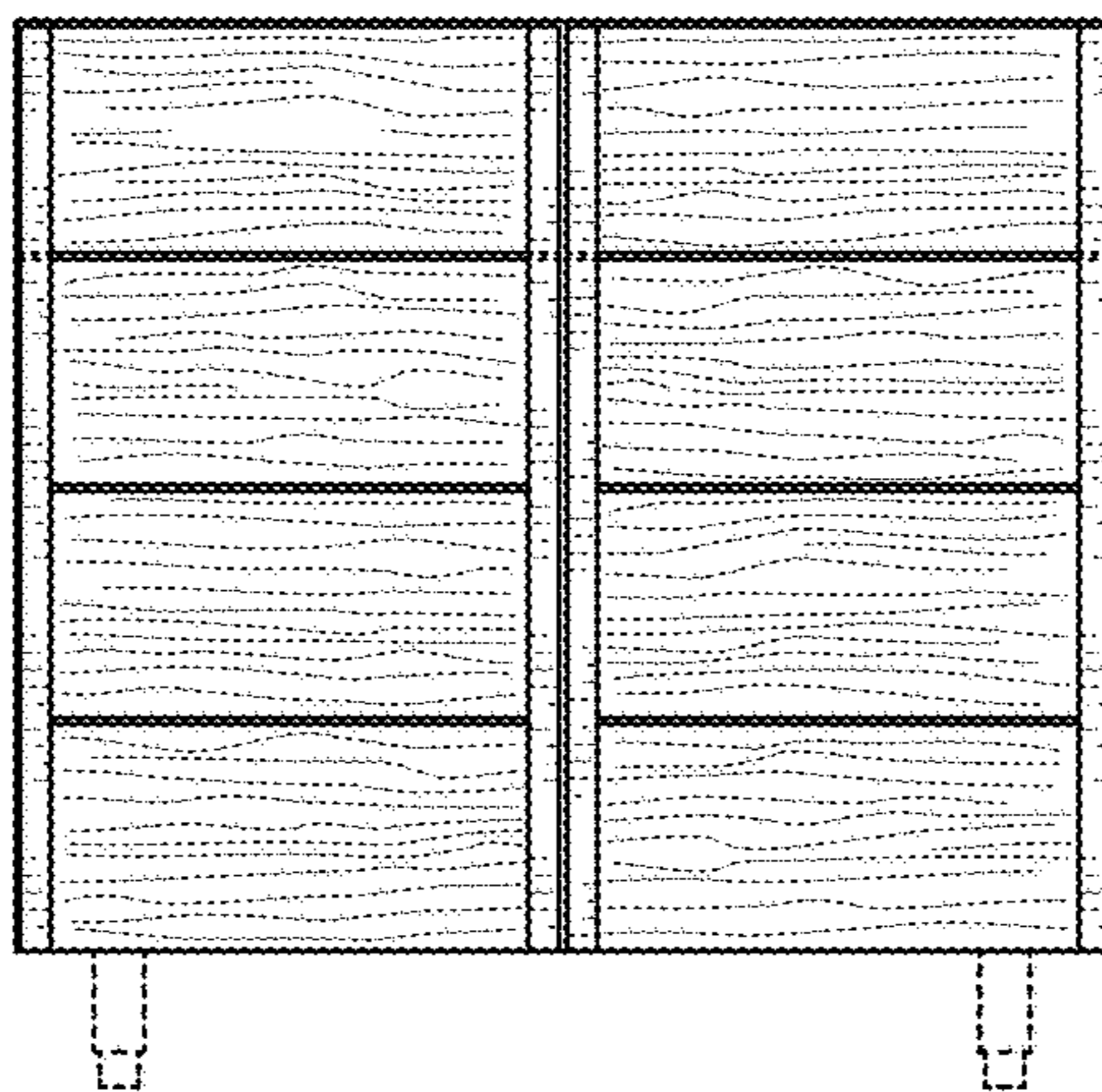

Fig. 11

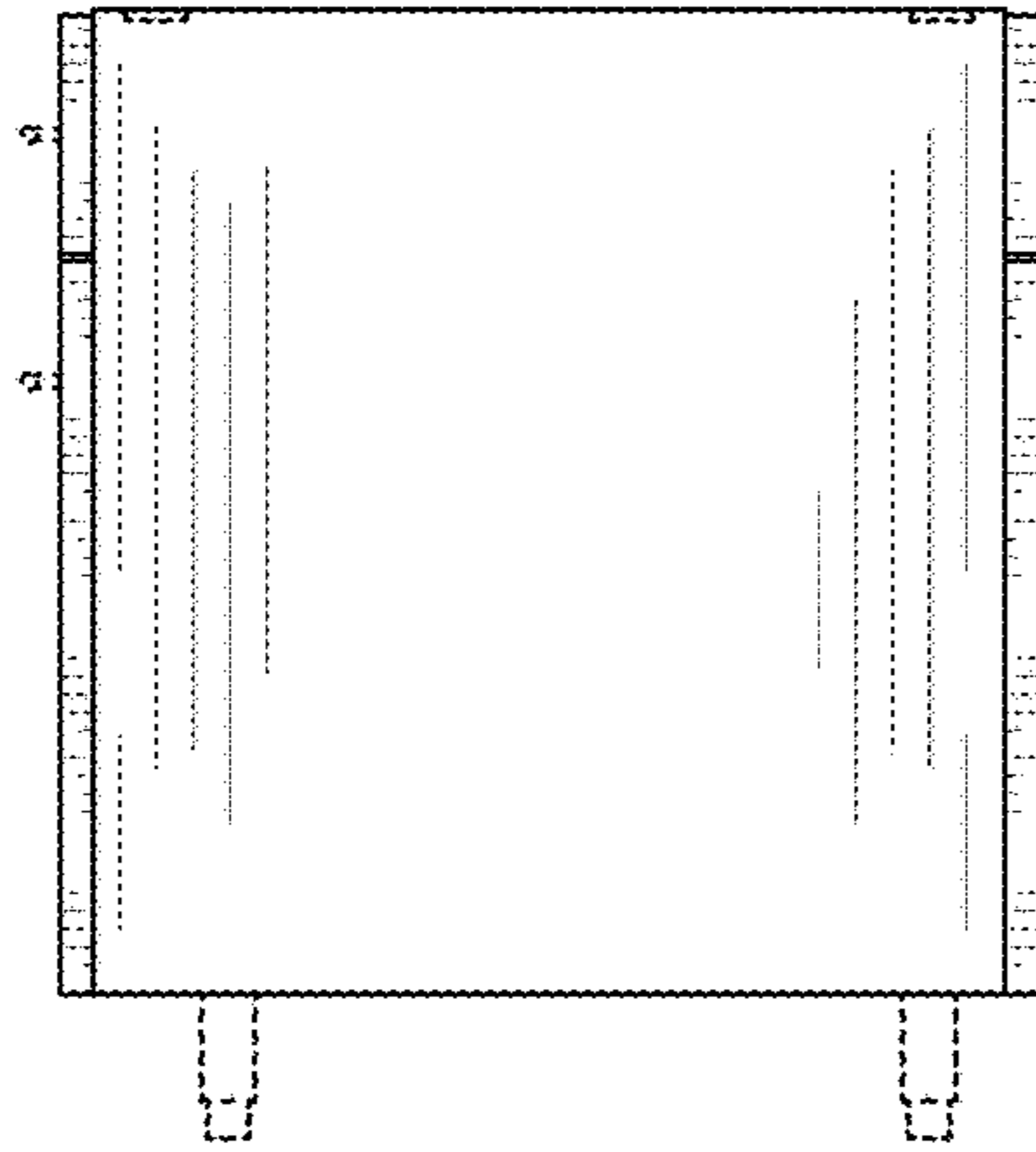

Fig. 12

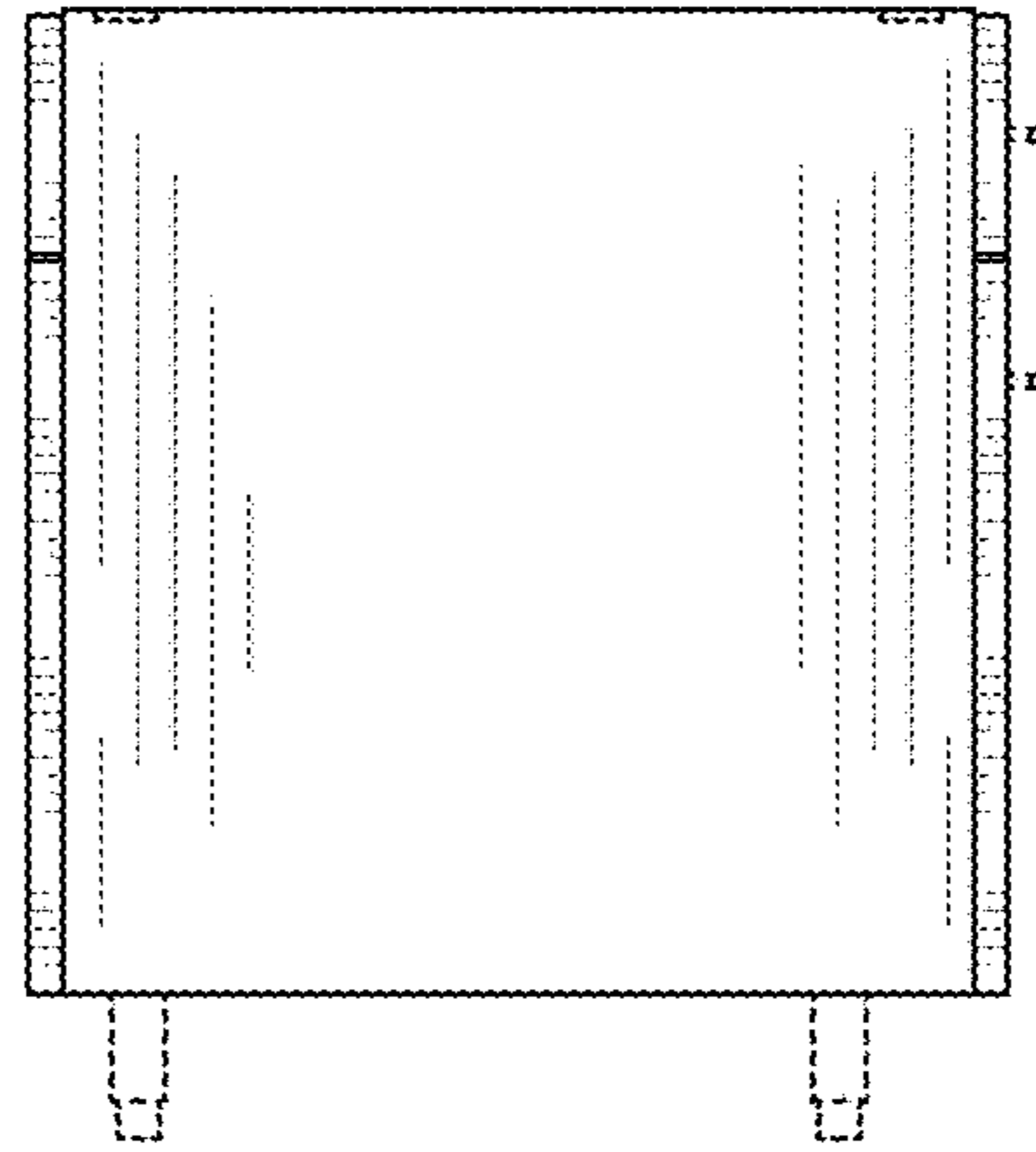

Fig. 13

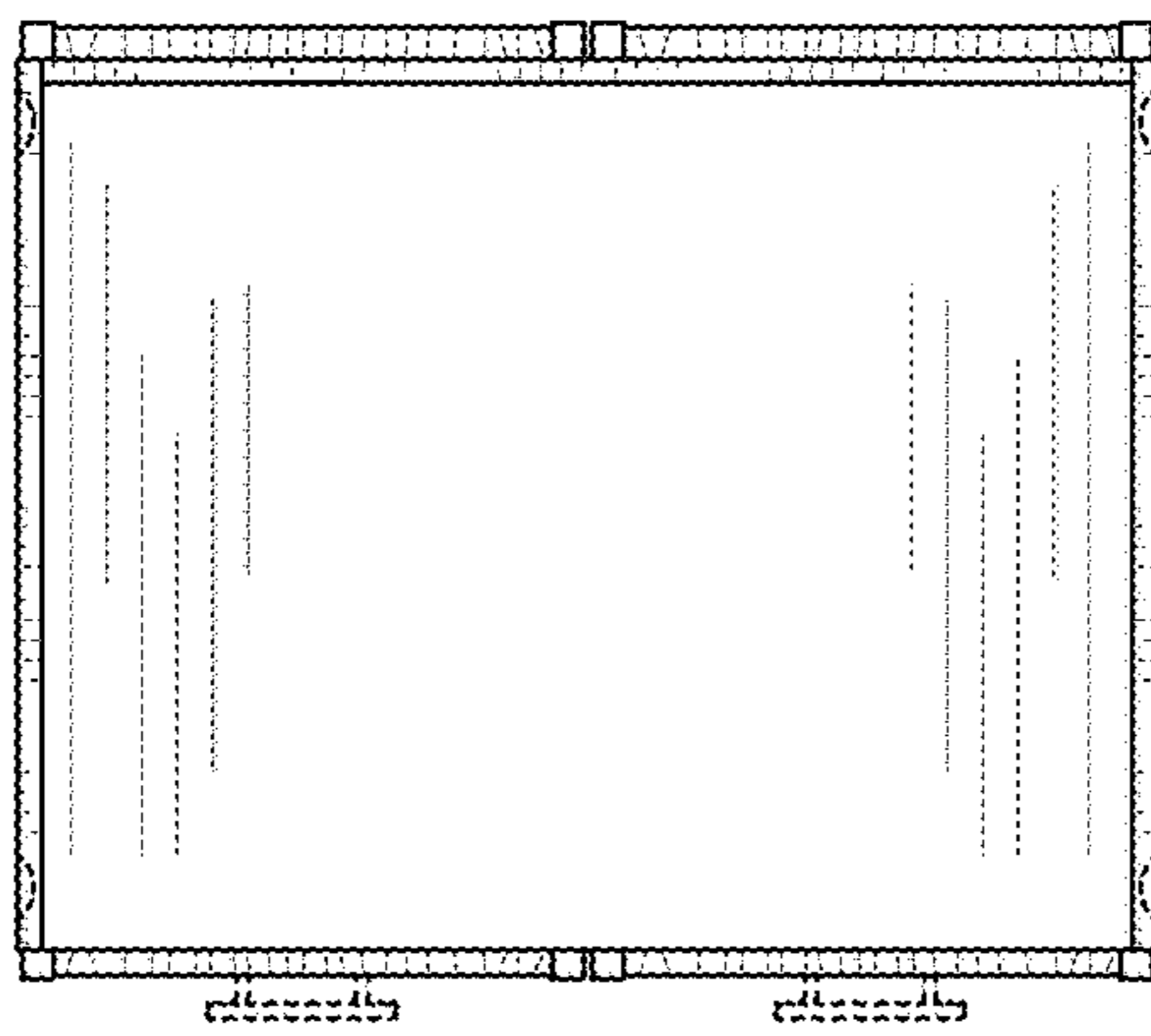

Fig. 14

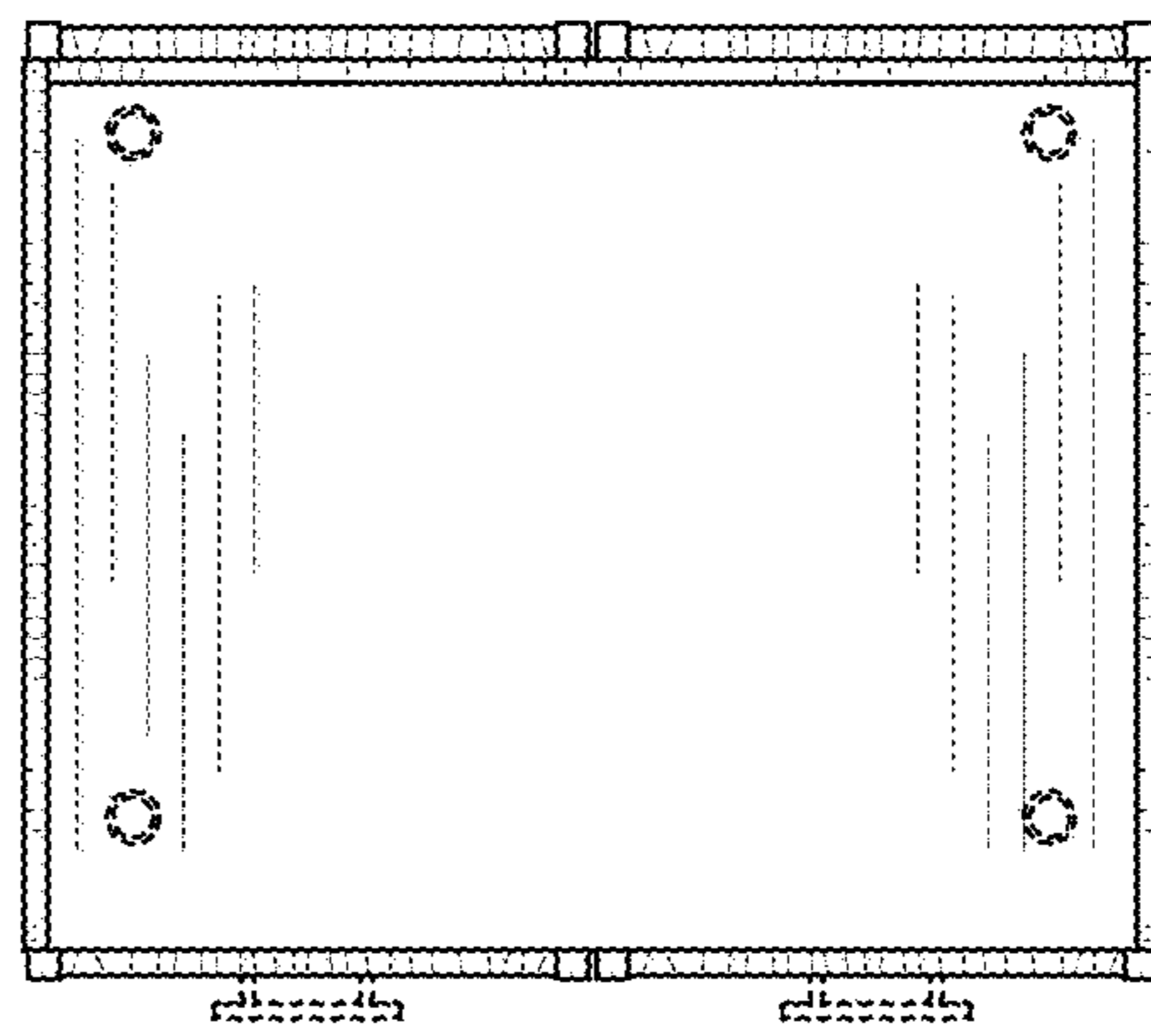

Fig. 15