



US00D862113S

(12) **United States Design Patent**  
**Downey et al.**

(10) **Patent No.:** **US D862,113 S**  
(45) **Date of Patent:** **\*\* Oct. 8, 2019**

(54) **BAR HOLDER FOR TOWEL OR PAPER ROLL**

D707,056 S \* 6/2014 Gilbert ..... D6/524  
D784,728 S 4/2017 Eads  
D836,946 S \* 1/2019 Rutgers ..... D6/549

(71) Applicant: **Spectrum Brands, Inc.**, Middleton, WI (US)

(72) Inventors: **David Downey**, Mission Viejo, CA (US); **Tony Zhang**, Xiamen (CN)

(73) Assignee: **Spectrum Brands Inc.**, Middleton, WI (US)

(\*\*) Term: **15 Years**

(21) Appl. No.: **29/626,022**

(22) Filed: **Nov. 14, 2017**

(51) **LOC (12) Cl.** ..... **23-02**

(52) **U.S. Cl.**  
USPC ..... **D6/546**

(58) **Field of Classification Search**  
USPC ..... D6/518, 519, 523, 524, 546-550;  
D8/300, 315, 370; 108/28, 29; 211/13.1,  
211/16, 85.5, 86.01, 87.01, 88.04, 100,  
211/105.1, 105.2, 105.3, 106, 113, 123,  
211/181.1, 182, 183; 242/570, 590, 595,  
242/598; 248/49, 175, 176.1, 200, 201,  
248/205.1, 251, 302, 309.1, 315  
CPC ..... A47K 10/04; A47K 10/02; A47K 10/10;  
A47K 10/3836; A47K 2010/324; A47K  
2010/389; B08B 1/006

See application file for complete search history.

(56) **References Cited**

**U.S. PATENT DOCUMENTS**

D516,350 S \* 3/2006 Chen ..... D6/549  
D523,272 S \* 6/2006 Ferrer Beltran ..... D6/546

**OTHER PUBLICATIONS**

Pfister, "Park Avenue 18" Towel Bar"; Publication date unknown but prior to filing date of present application; Date Accessed: Oct. 22, 2017; URL: <<https://www.pfisterfaucets.com/bath/product/park-avenue-18-towel-bar-bib-fe1k>>.

\* cited by examiner

*Primary Examiner* — Wan Laymon

*Assistant Examiner* — Mark Booker

(74) *Attorney, Agent, or Firm* — Banner & Witcoff, Ltd.

(57) **CLAIM**

The ornamental design for a bar holder for towel or paper roll, as shown and described.

**DESCRIPTION**

FIG. 1 is a front perspective view of a bar holder for towel or paper roll showing our new design; FIG. 2 is a front view thereof; FIG. 3 is a right side view thereof; FIG. 4 is a left side view thereof; FIG. 5 is a top view thereof; and, FIG. 6 is a bottom view thereof.

The broken away symbols in the drawings indicate that any portion of the article beyond what is shown forms no part of the claimed design. The broken line showing of the interior portion of the bar holder for a towel or paper roll is for environmental purposes only and forms no part of the claimed design.

**1 Claim, 5 Drawing Sheets**

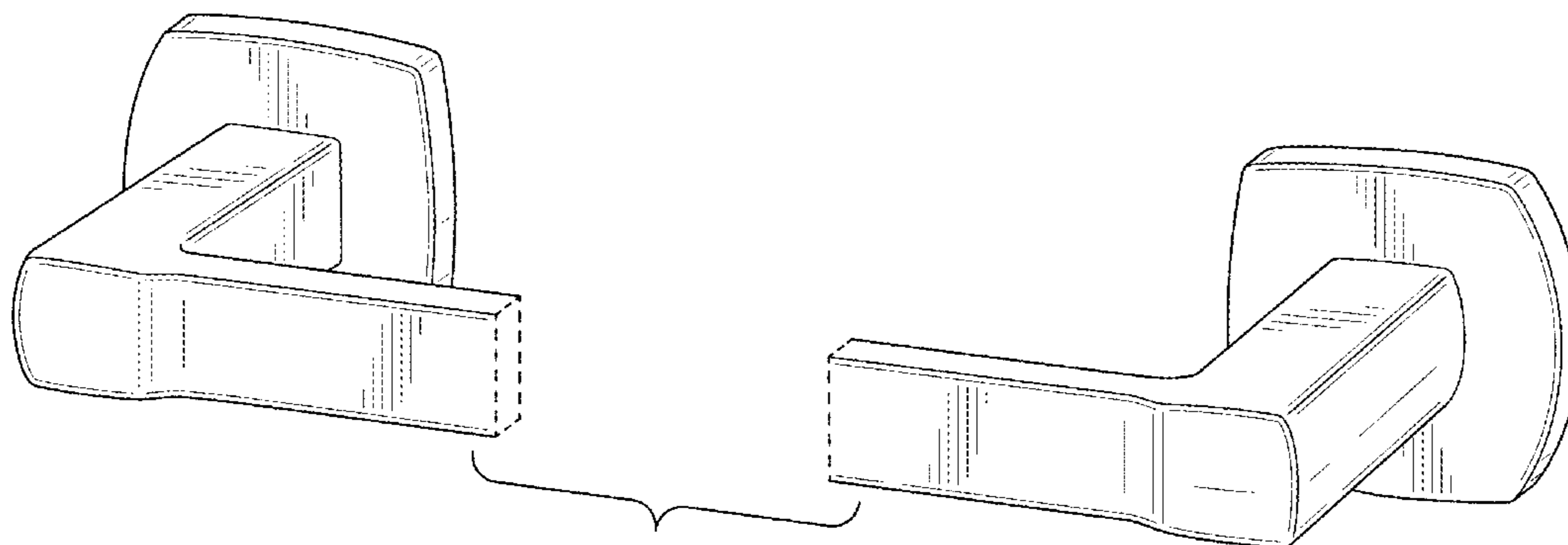

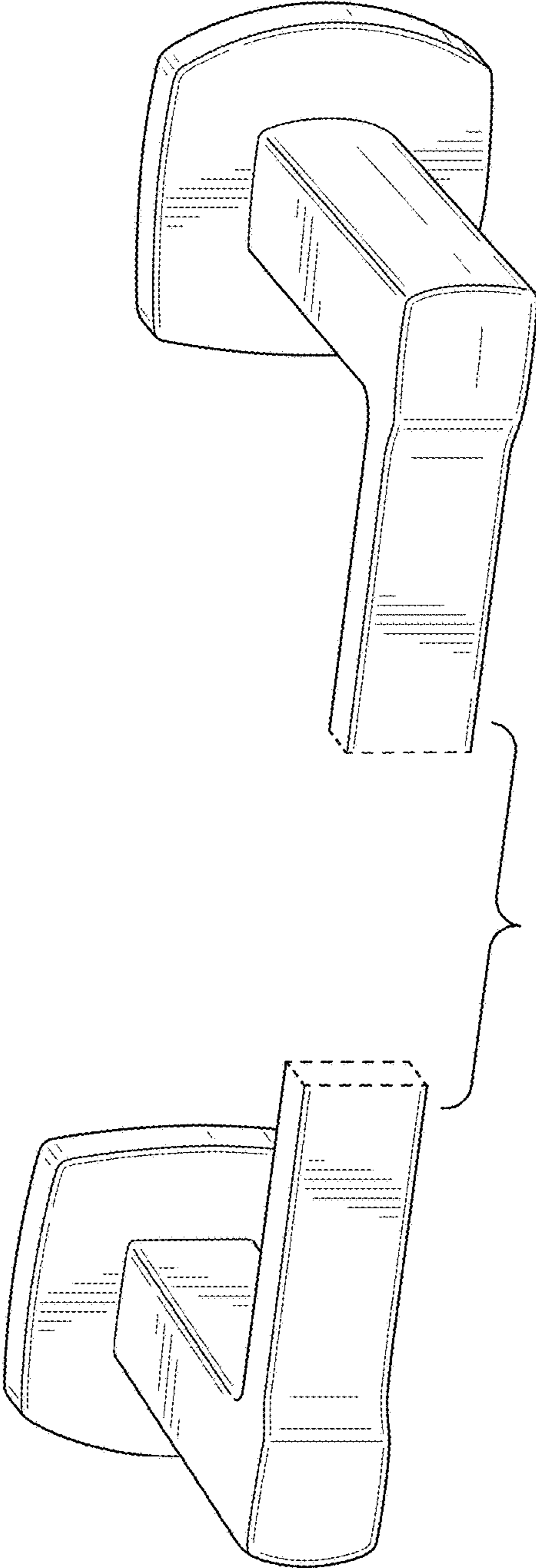

FIG. 1

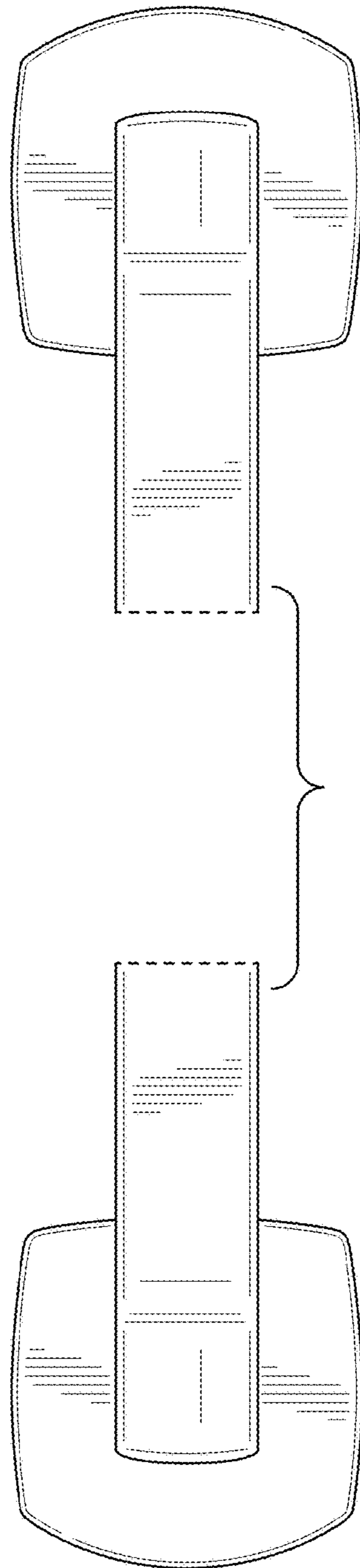

FIG. 2

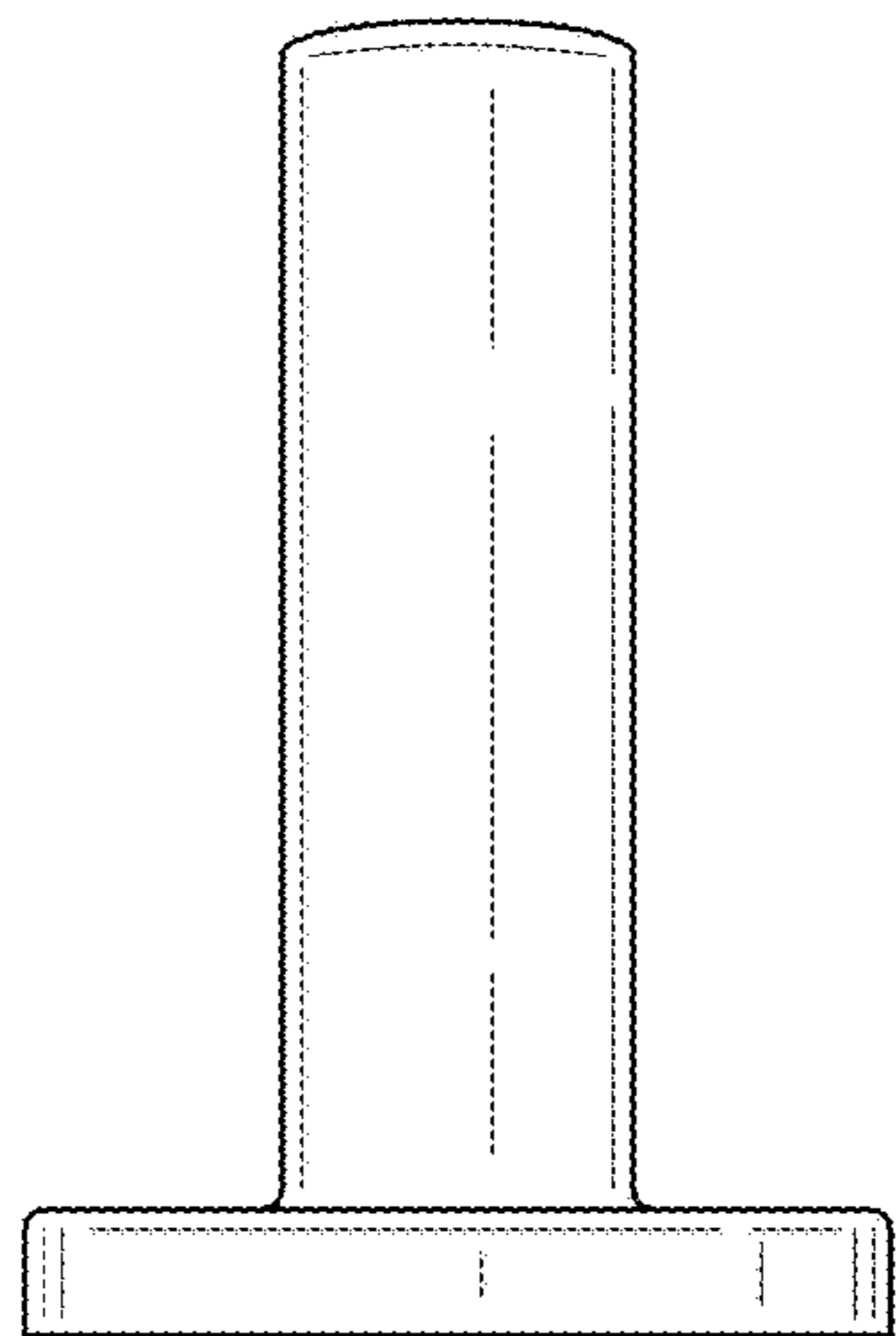

FIG. 4

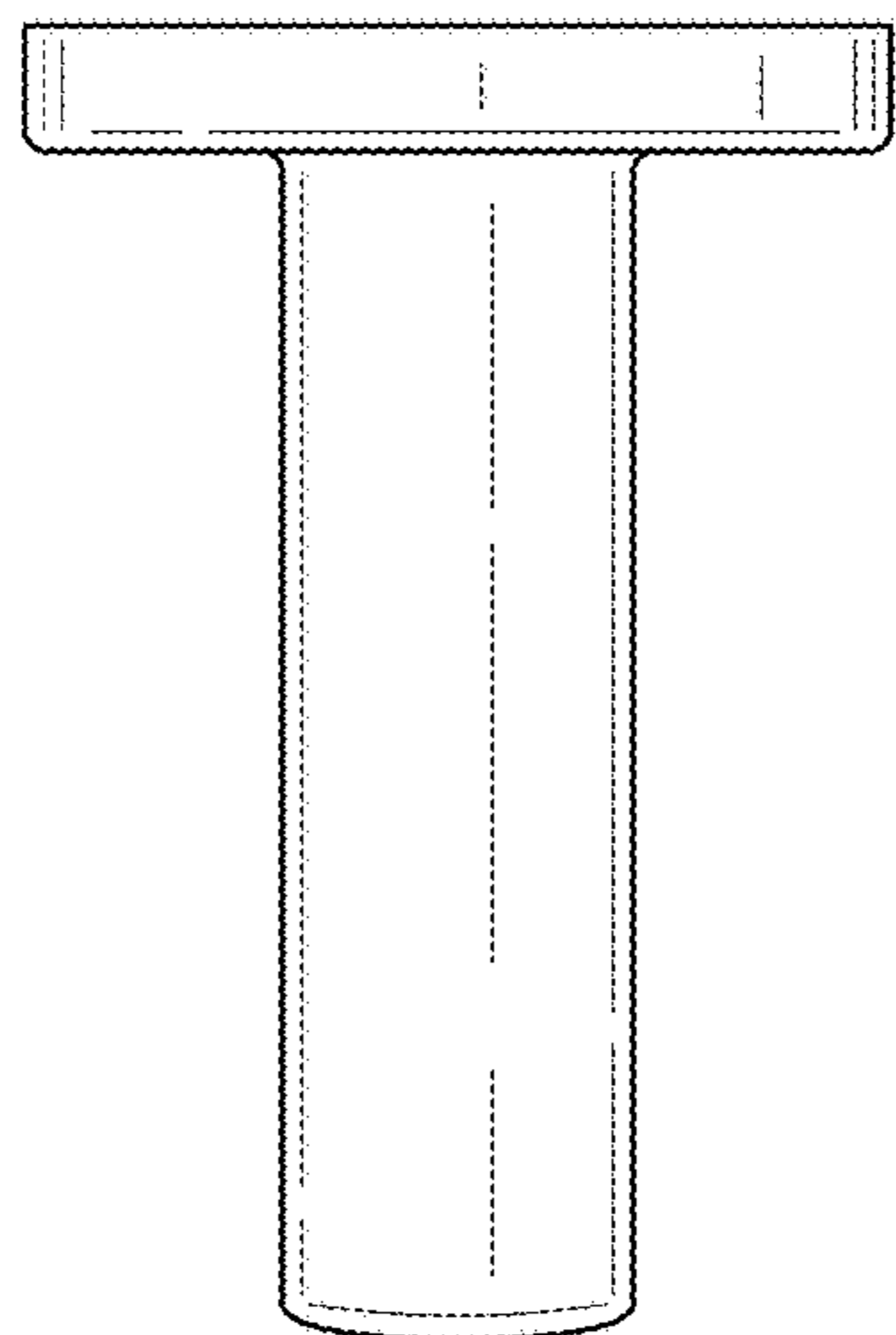

FIG. 3

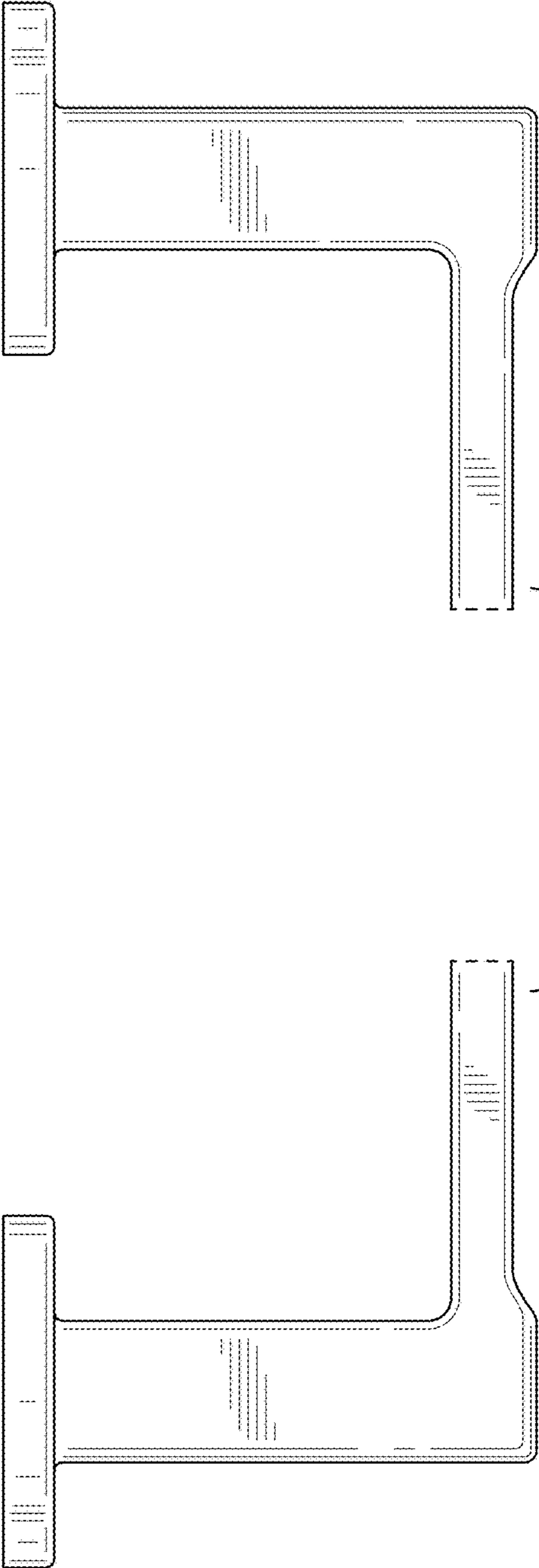

FIG. 5

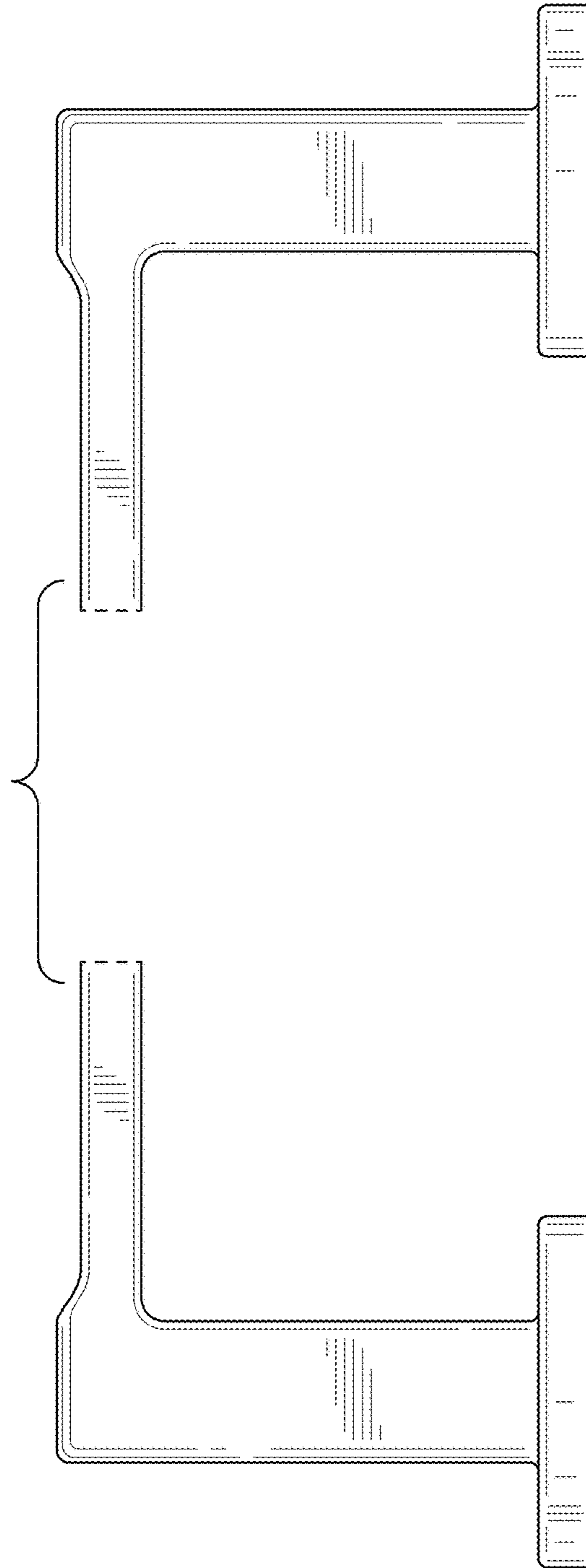

FIG. 6