



US00D862068S

(12) **United States Design Patent**  
**Justiss**

(10) **Patent No.:** **US D862,068 S**

(45) **Date of Patent:** **\*\* Oct. 8, 2019**

- (54) **MAGNETIC KEY ORGANIZER**
- (71) Applicant: **Distil Union, LLC**, North Charleston, SC (US)
- (72) Inventor: **Nate Justiss**, North Charleston, SC (US)
- (73) Assignee: **Distil Union, LLC**, Charleston, SC (US)
- (\*\*) Term: **15 Years**
- (21) Appl. No.: **29/696,836**
- (22) Filed: **Jul. 1, 2019**
- (51) **LOC (12) Cl.** ..... **03-01**
- (52) **U.S. Cl.**  
USPC ..... **D3/207**
- (58) **Field of Classification Search**  
USPC ..... D3/207-212; 70/456 B, 457, 458, 408, 70/456 R; D8/347, 98, 99, 100, 105, 107; D14/496, 411; 206/37.1; 24/3.6, 457, 24/458; D11/11, 79, 81, 82, 86, 87  
CPC ..... A45C 11/32; A47G 29/10; H04B 1/034; F04B 15/00; E05B 19/04; A44B 15/00; A44B 15/002; A44B 15/005; A44B 15/007  
See application file for complete search history.

1,609,347 A \* 12/1926 Dee ..... A45F 5/02 24/3.6  
 1,829,136 A \* 10/1931 Halley ..... A45F 5/02 24/3.6  
 2,640,237 A \* 6/1953 Vaisey ..... A44B 15/00 24/371

(Continued)

**FOREIGN PATENT DOCUMENTS**

CN 203314242 \* 12/2013 ..... A44B 15/00  
 CN 204635279 \* 9/2015 ..... A44B 15/00

**OTHER PUBLICATIONS**

Ferris: Easily organize, instantly share + keep keys tidy, Kickstarter.com, Created by Distil Union, Funding period: May 13, 2019-Jun. 24, 2019, [online], [site visited Aug. 2, 2019]. <URL: <https://www.kickstarter.com/projects/distilunion/ferris-modular-key-organizer-wallet-to-simplify-yo>> (Year: 2019).\*

(Continued)

*Primary Examiner* — T Chase Nelson  
*Assistant Examiner* — Jonathan J. Han  
 (74) *Attorney, Agent, or Firm* — Gregory Finch; Finch Paolino, LLC

(57) **CLAIM**

The ornamental design for a magnetic key organizer, as shown and described.

**DESCRIPTION**

FIG. 1 is an isometric view of the claimed magnetic key organizer, embodying the present design;  
 FIG. 2 is a front view thereof;  
 FIG. 3 is a rear view thereof;  
 FIG. 4 is a right side view thereof;  
 FIG. 5 is a left side view thereof;  
 FIG. 6 is a top plan view thereof;  
 FIG. 7 is a bottom plan view thereof; and,  
 FIG. 8 is another isometric view of the magnetic key organizer in an open configuration.

**1 Claim, 8 Drawing Sheets**

(56) **References Cited**  
**U.S. PATENT DOCUMENTS**

1,327,534 A \* 1/1920 Eichstedt ..... A45F 5/02 24/3.6  
 1,349,468 A \* 8/1920 Morrison ..... A45F 5/02 24/3.6  
 1,497,346 A \* 6/1924 Peterson ..... A45F 5/02 24/3.6  
 1,539,220 A \* 5/1925 Taylor ..... A45F 5/02 24/3.6

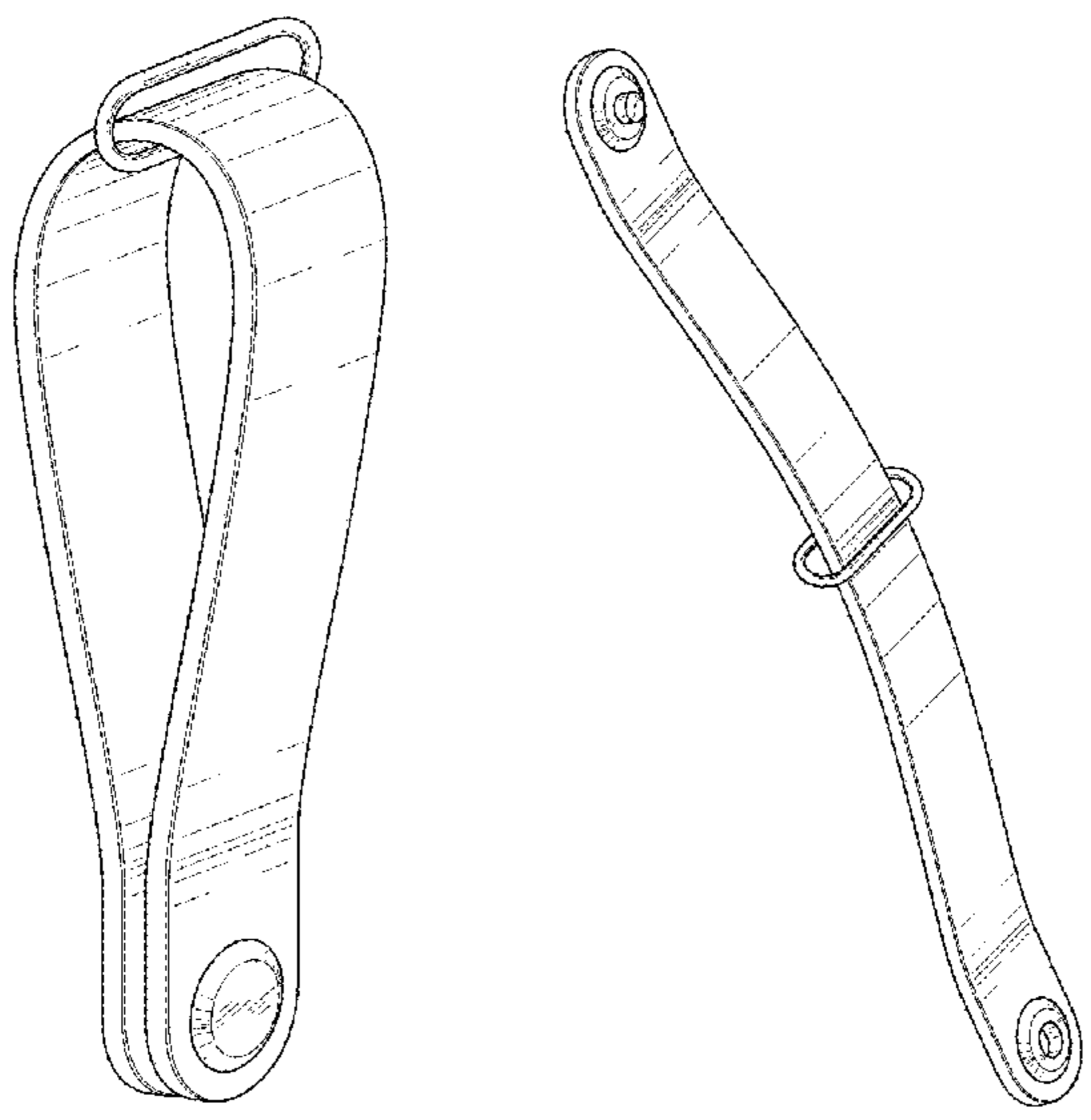

(56)

References Cited

U.S. PATENT DOCUMENTS

2,986,786 A \* 6/1961 Hill ..... A45F 5/02  
24/3.6

3,086,268 A 4/1963 Chaffin, Jr.

3,177,546 A 4/1965 Bey

4,358,036 A \* 11/1982 Maltais ..... A45F 5/02  
224/163

4,432,219 A 2/1984 Bassett

4,592,157 A 6/1986 Kerr

5,024,078 A 6/1991 Fenwick

5,388,439 A 2/1995 Miller

D435,720 S \* 1/2001 Perthou ..... D3/205

D438,373 S \* 3/2001 Riley ..... D3/207

6,260,749 B1 7/2001 Horovitz

6,812,817 B2 11/2004 Thibideau

D506,056 S \* 6/2005 Burns ..... D3/207

D541,190 S \* 4/2007 Plzak ..... D11/200

D557,008 S \* 12/2007 Stiller ..... D3/207

D638,330 S \* 5/2011 Fahrenedorff ..... D11/200

8,104,315 B2 \* 1/2012 Perthou ..... A44B 15/00  
206/38.1

D694,478 S \* 11/2013 Ali ..... D30/153

D699,002 S \* 2/2014 Connolly ..... D28/73

D714,537 S \* 10/2014 Busch ..... D3/207

8,959,722 B2 \* 2/2015 Allen, Sr. .... A45F 5/022  
224/269

D739,144 S \* 9/2015 Kinskey ..... D3/318

D754,964 S \* 5/2016 Hernandez ..... D3/207

D756,629 S \* 5/2016 Tunney ..... D3/207

9,468,285 B2 10/2016 Martinez

D781,571 S \* 3/2017 Moerer ..... D3/215

D788,108 S \* 5/2017 Cai ..... D14/411

D793,075 S \* 8/2017 Ma ..... D3/207

D806,715 S \* 1/2018 Chen ..... D14/480.6

D819,598 S \* 6/2018 Won ..... D14/215

D819,958 S \* 6/2018 LiCalsi ..... D3/207

D826,550 S \* 8/2018 Filakousky ..... D3/207

D838,100 S \* 1/2019 Wang ..... D3/207

D844,317 S \* 4/2019 Poletowski ..... D3/207

2002/0173692 A1 11/2002 Kaufman et al.

2003/0051520 A1 3/2003 Janssen et al.

2003/0131450 A1 \* 7/2003 Turesin ..... E05B 75/00  
24/3.6

2004/0079125 A1 4/2004 Morehart et al.

2007/0199356 A1 8/2007 Owens et al.

2008/0087063 A1 \* 4/2008 Tzu-Shun ..... A44B 15/00  
70/457

2009/0095039 A1 \* 4/2009 Nagamine ..... A45C 13/30  
70/457

2013/0139357 A1 \* 6/2013 Allen, Sr. .... A45F 5/022  
24/3.6

2015/0034796 A1 \* 2/2015 Jones ..... H05K 5/0234  
248/558

OTHER PUBLICATIONS

Ferris Modular Key System by Distil Union on Kickstarter, YouTube.com, Distil Union, Published on May 16, 2019, [online], [site visited Aug. 2, 2019]. <URL: [https://www.youtube.com/watch?v=\\_rhQfiMI-HM](https://www.youtube.com/watch?v=_rhQfiMI-HM)> (Year: 2019).\*

Black magnetic keychain. Leather keys organizer, Amazon.com, [online], [site visited Aug. 2, 2019]. <URL: <https://www.amazon.com/keychain-Leather-organizer-Minimalist-accessories/dp/B076MHYFGP>> (Year: 2019).\*

Super Duty Leather Belt Snap Open Key Holder, AVCOkey.com, [online], [site visited Aug. 2, 2019]. <URL: <https://www.avcokey.com/super-duty-leather-belt-snap-key-holder.aspx>> (Year: 2019).\*

Australian Trademark Registration No. 1853365. Date of registration: Jun. 18, 2019. Australian Government/IP Australia. Viewed online at <https://search.ipaustralia.gov.au/trademarks/search/view/1853365?q=1853365>.

\* cited by examiner

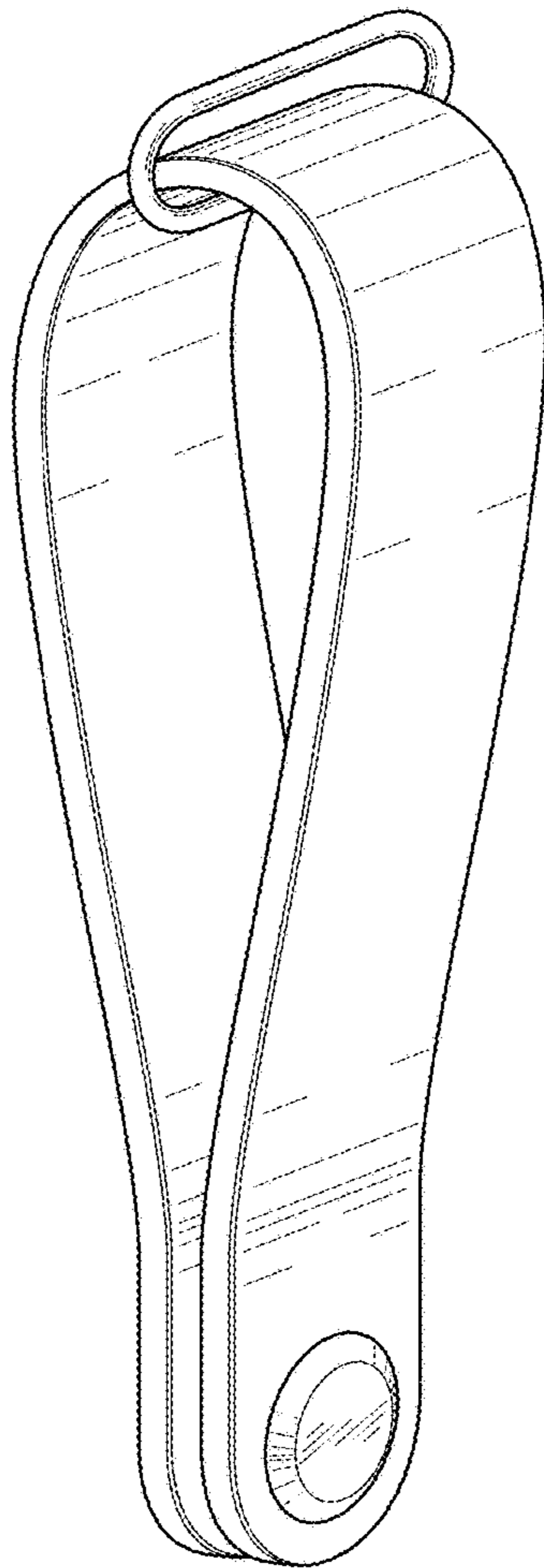

Fig. 1

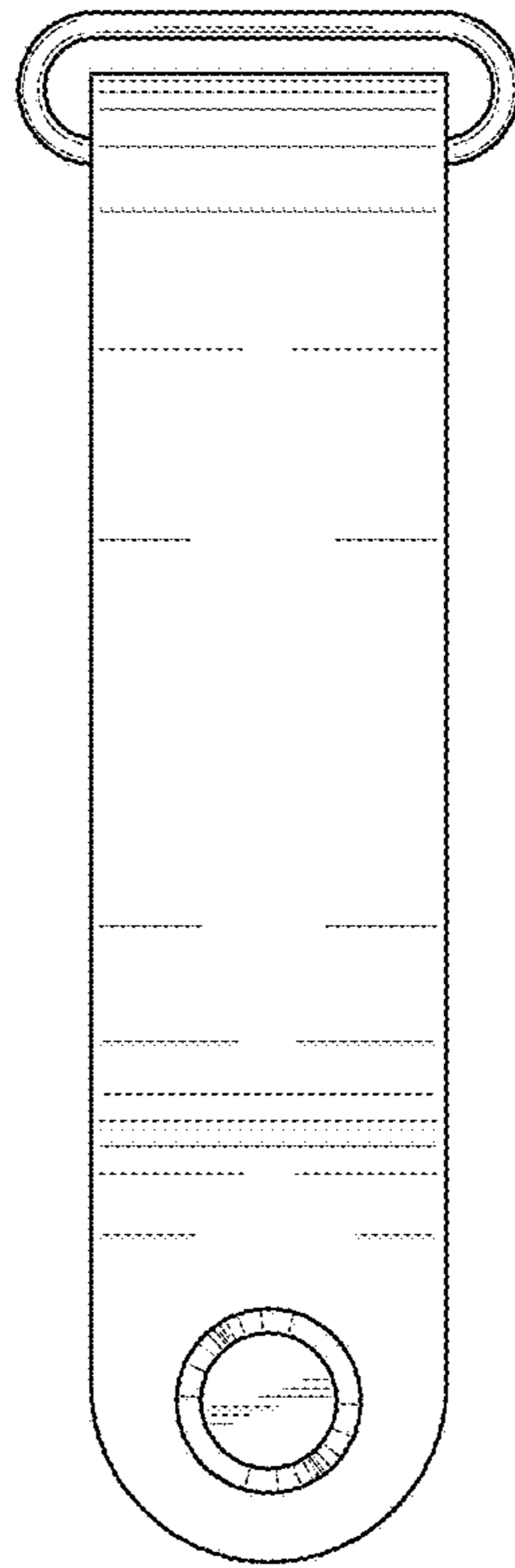

Fig. 2

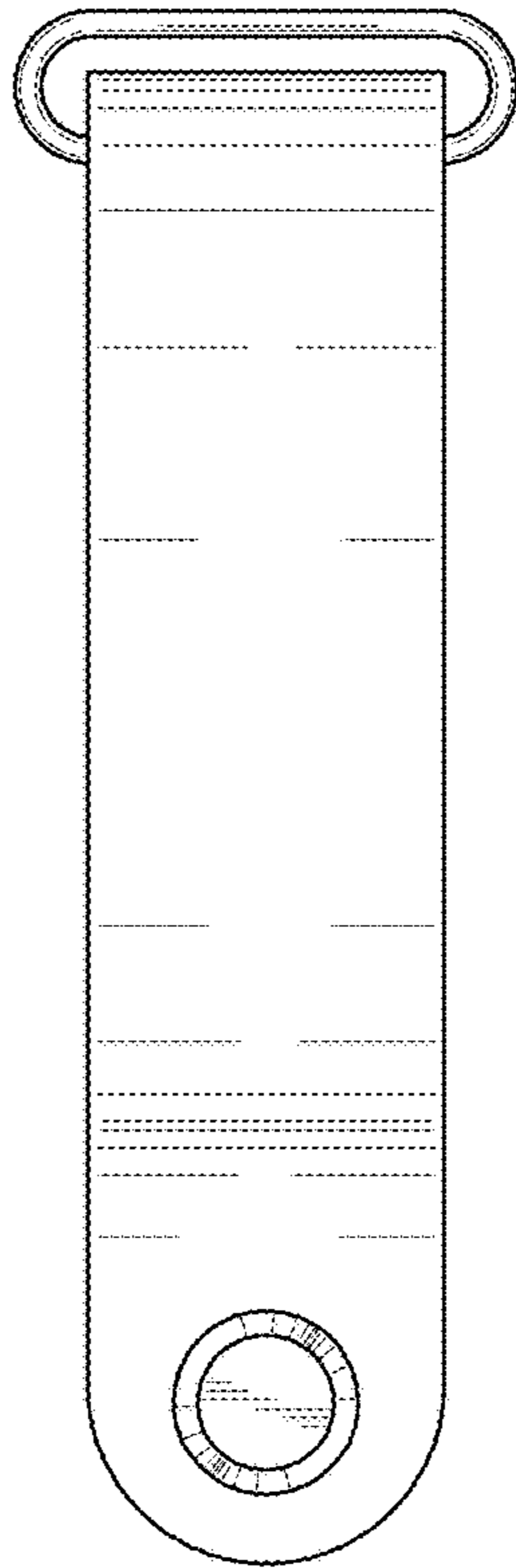

Fig. 3

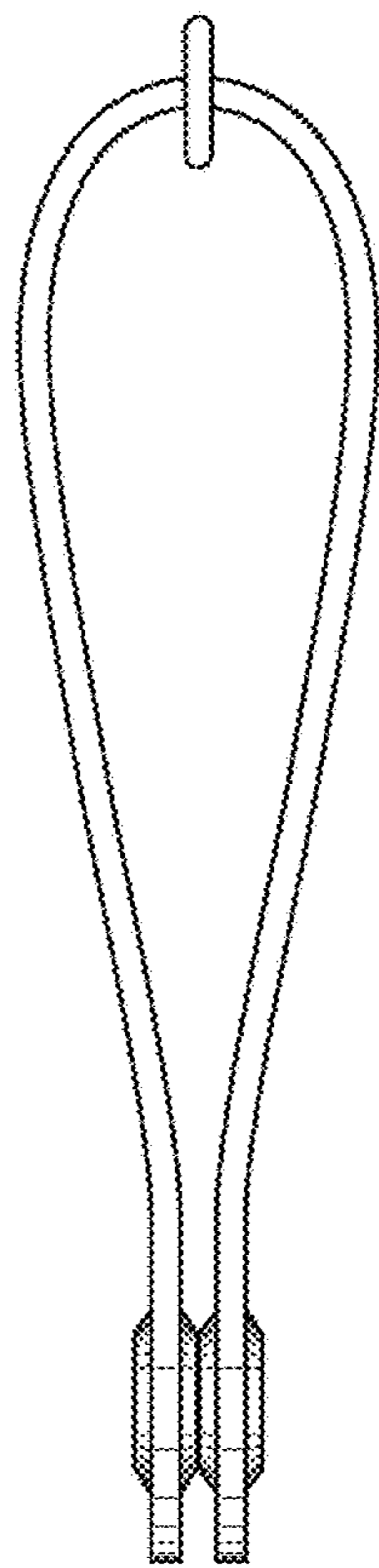

Fig. 4

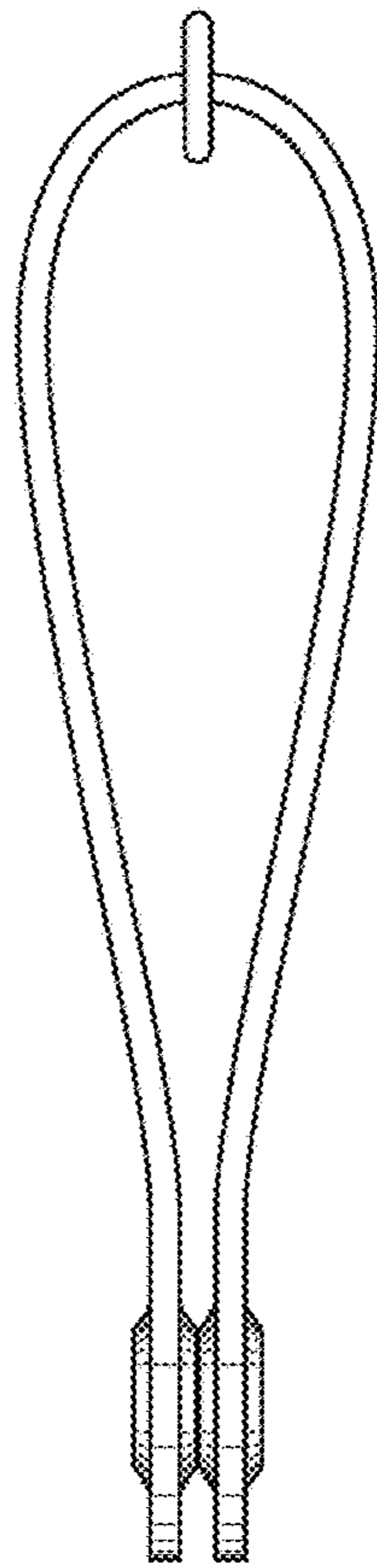

Fig. 5

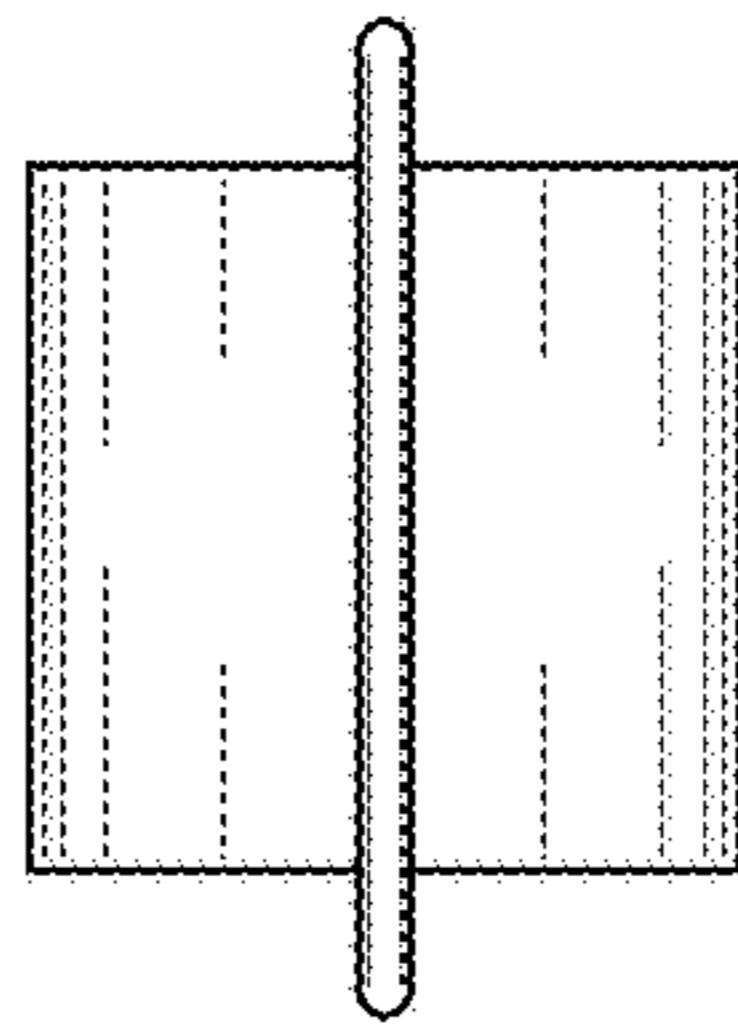

Fig. 6



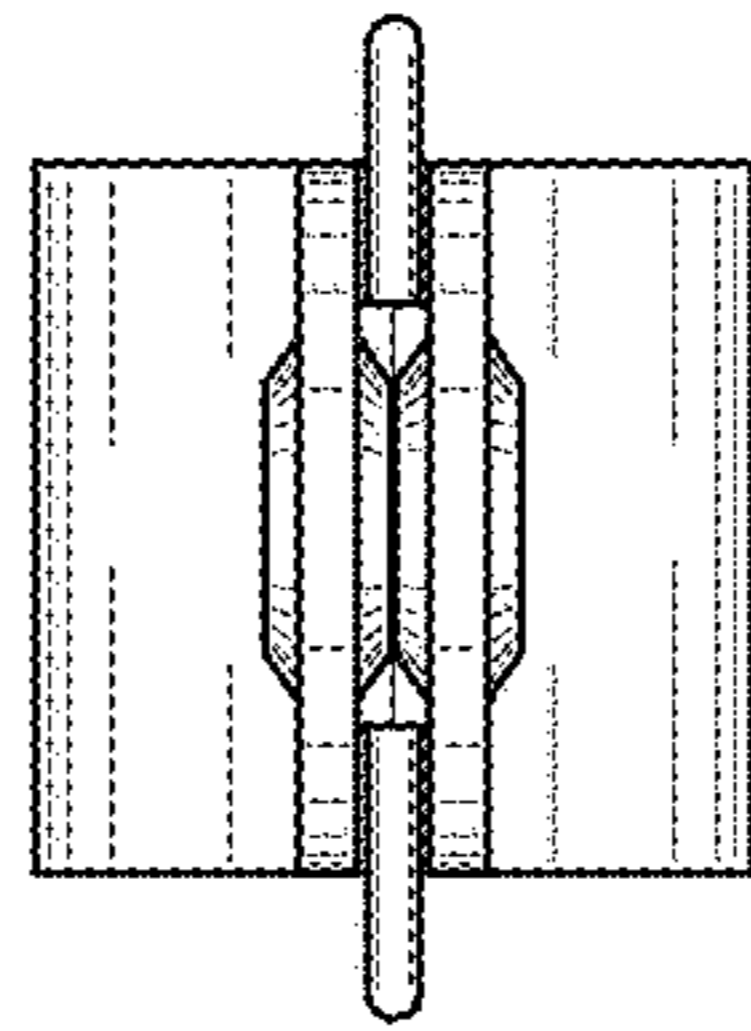

Fig. 7

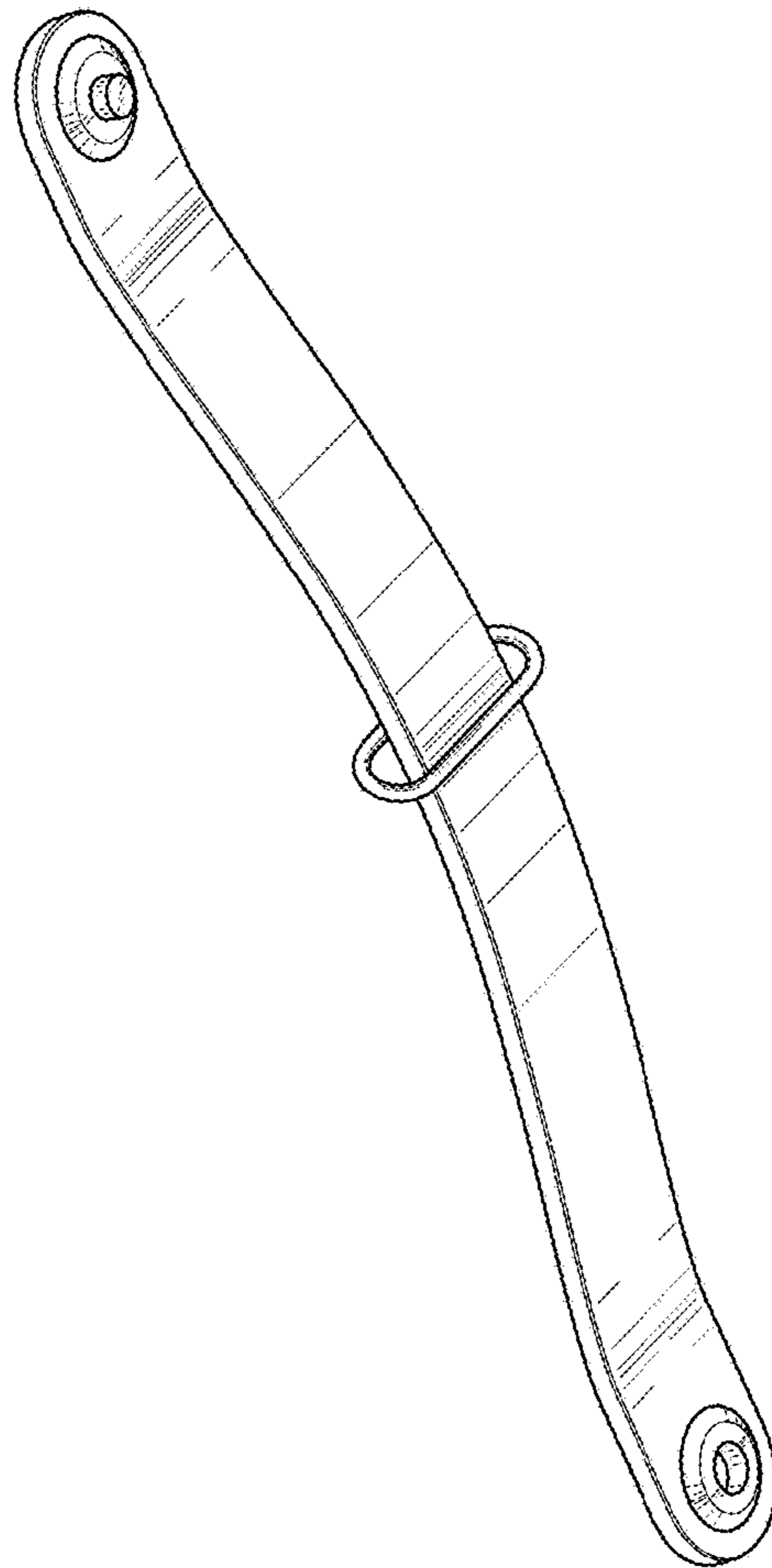

Fig. 8