



US00D862058S

(12) **United States Design Patent**  
**Duarte**

(10) **Patent No.:** **US D862,058 S**

(45) **Date of Patent:** **\*\* Oct. 8, 2019**

- (54) **TRANSFORMABLE SHOE SOLE**
- (71) Applicant: **Cynthia Karely Duarte**, Greenfield, CA (US)
- (72) Inventor: **Cynthia Karely Duarte**, Greenfield, CA (US)
- (\*\*) Term: **15 Years**
- (21) Appl. No.: **29/628,786**
- (22) Filed: **Dec. 7, 2017**
- (51) **LOC (12) Cl.** ..... **02-04**
- (52) **U.S. Cl.**  
USPC ..... **D2/950**; D2/947; D2/951
- (58) **Field of Classification Search**  
USPC ..... D2/902, 906, 908, 916, 918, 925, D2/946-962, 977; 36/1, 1.5, 3 B, 22 R, 36/24.5, 25 R, 28, 32 R, 34 R, 59 C, 36/67 A, 101-107, 114-116, 117.3, 117.4, 36/124-136; D12/544  
CPC ..... A43B 13/00; A43B 13/02; A43B 13/023; A43B 13/026; A43B 13/04; A43B 13/08; A43B 13/10; A43B 13/12; A43B 13/14; A43B 13/141; A43B 13/143; A43B 13/16; A43B 13/18; A43B 13/181; A43B 13/187; A43B 13/189; A43B 13/20; A43B 13/22; A43B 13/223; A43B 13/24; A43B 13/28; A43B 13/30; A43B 13/32; A43B 13/34; A43B 13/36  
See application file for complete search history.

(56) **References Cited**

**U.S. PATENT DOCUMENTS**

- 2,303,431 A \* 12/1942 Brophy ..... A43B 13/32 36/11.5
- D170,015 S \* 7/1953 Ferragamo ..... D2/939
- 4,363,177 A \* 12/1982 Boros ..... A43B 21/39 36/101
- 4,400,893 A \* 8/1983 Musci ..... A43B 13/34 12/142 J

- 6,023,858 A \* 2/2000 Srourian ..... A43B 3/24 36/11.5
  - D582,637 S \* 12/2008 Guers-Neyraud ..... D2/925
  - D594,637 S \* 6/2009 Van Hulle ..... D2/925
- (Continued)

**OTHER PUBLICATIONS**

These shoes transform from flats to heels in seconds, YouTube.com, Insider, Published on Nov. 8, 2016, [online], [site visited Dec. 29, 2018]. <URL: <https://www.youtube.com/watch?v=Y8TFBRxghxc>> (Year: 2016).\*

(Continued)

*Primary Examiner* — T Chase Nelson  
*Assistant Examiner* — Jonathan J. Han

(57) **CLAIM**

The ornamental design for a transformable shoe sole, as shown and described.

**DESCRIPTION**

FIG. 1 is a top perspective view of a transformable shoe sole showing my new design;  
FIG. 2 is a bottom perspective view thereof;  
FIG. 3 is a top perspective view, showing the transformable shoe sole in an alternate, flat configuration;  
FIG. 4 is a bottom perspective view, showing the transformable shoe sole in an alternate, flat configuration;  
FIG. 5 is a front view thereof;  
FIG. 6 is a back view thereof;  
FIG. 7 is a top view thereof;  
FIG. 8 is a bottom view thereof;  
FIG. 9 is a left view thereof; and,  
FIG. 10 is a right view thereof.

The broken lines showing of a shoe body in FIGS. 1-10, the broken lines showing of a bendable heel in FIGS. 1-4, FIG. 6, and FIGS. 8-10 are included for the purpose of showing environmental structure and form no part of the claimed design.

**1 Claim, 10 Drawing Sheets**

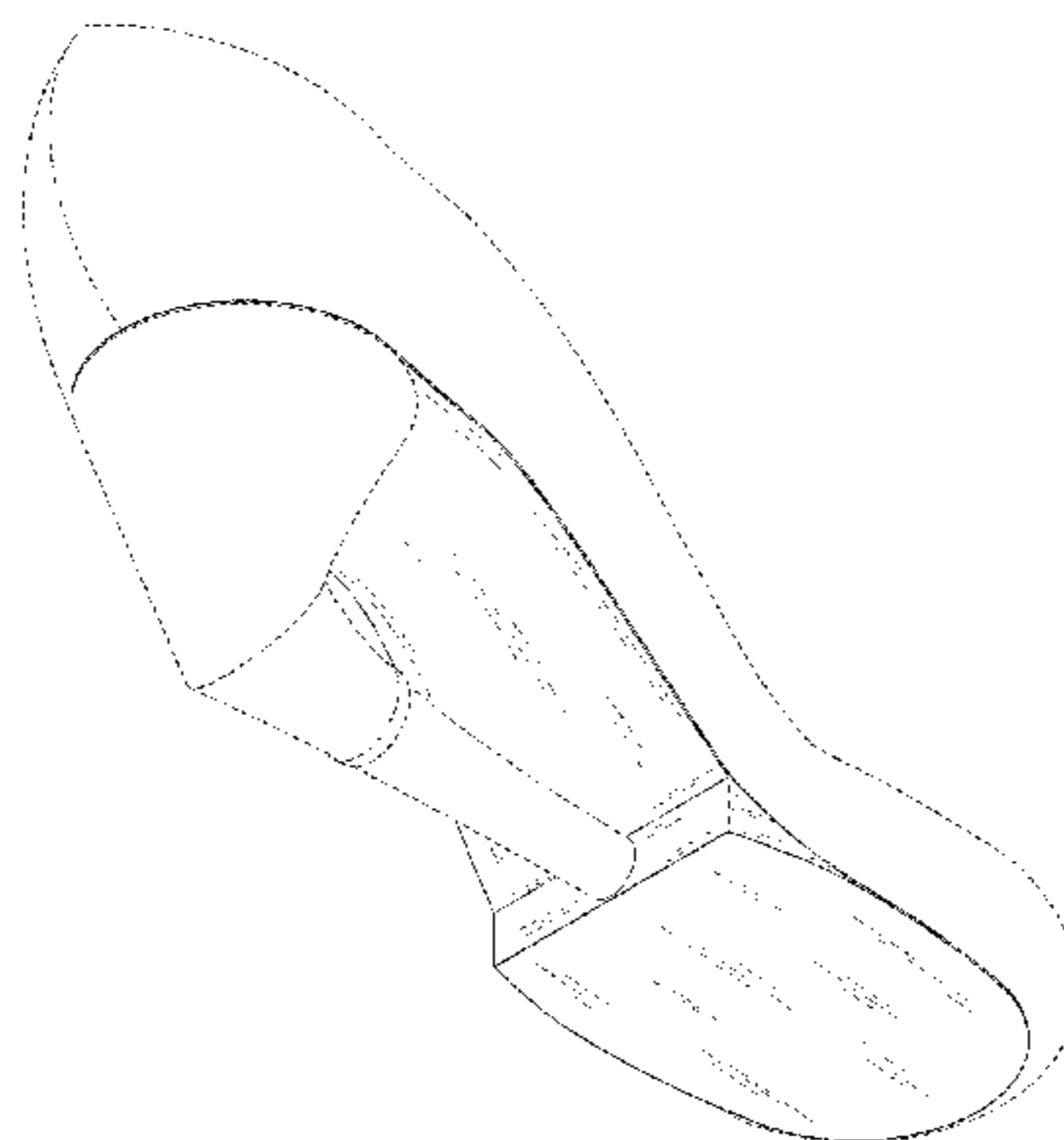
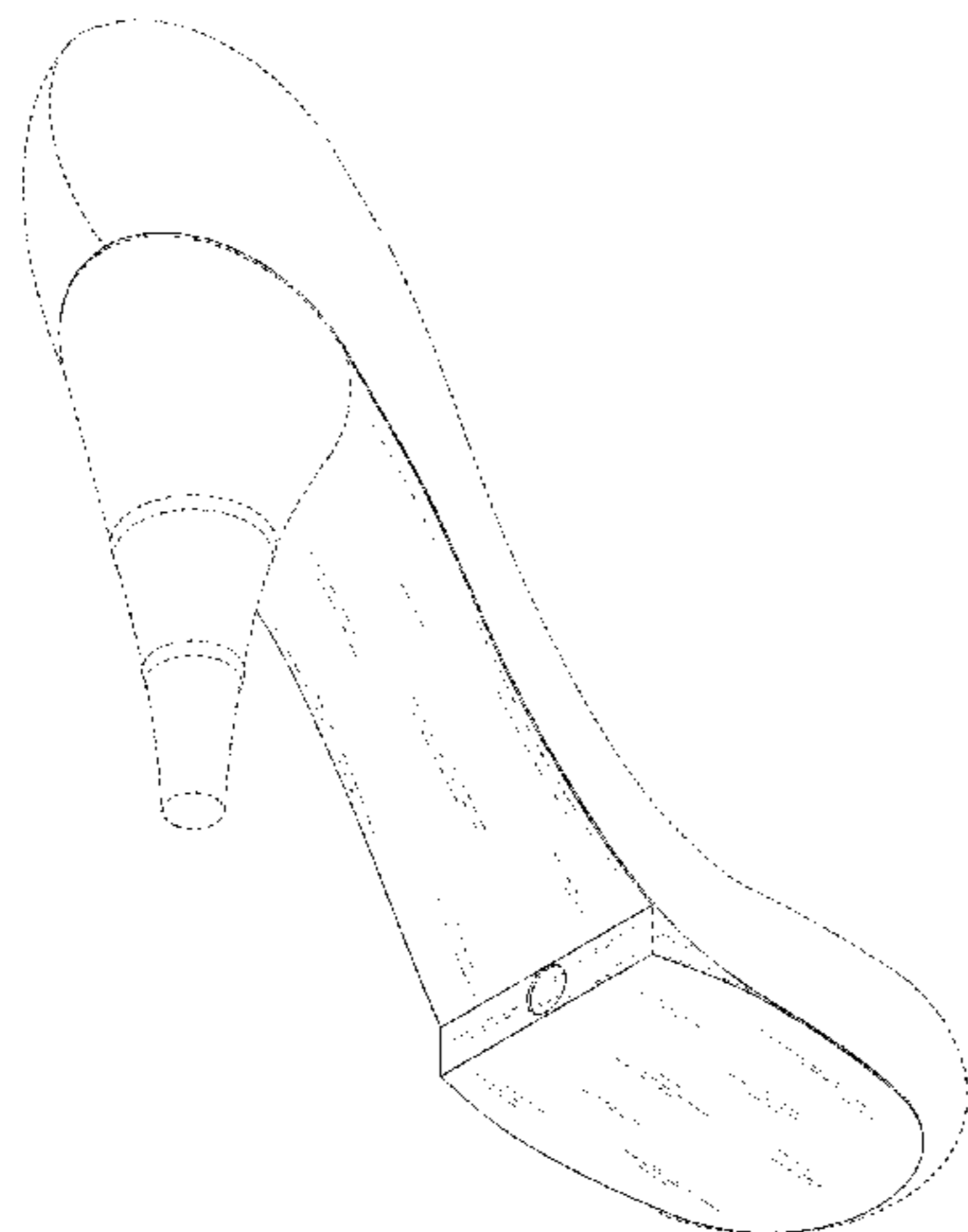

(56)

References Cited

U.S. PATENT DOCUMENTS

D595,034 S \* 6/2009 Van Hulle ..... D2/925  
 D632,061 S \* 2/2011 Hardy ..... D2/929  
 D659,962 S \* 5/2012 Vazquez ..... D2/949  
 D664,333 S \* 7/2012 Garcia Mira ..... D2/925  
 D734,004 S \* 7/2015 Slimane ..... D2/939  
 D738,598 S \* 9/2015 Sassi ..... D2/929  
 9,220,317 B2 \* 12/2015 Green ..... A43B 13/04  
 D749,309 S \* 2/2016 Weitzman ..... D2/950  
 D749,832 S \* 2/2016 Weitzman ..... D2/950  
 D750,876 S \* 3/2016 Weitzman ..... D2/950  
 D750,877 S \* 3/2016 Weitzman ..... D2/950  
 D750,878 S \* 3/2016 Weitzman ..... D2/950  
 9,326,565 B1 \* 5/2016 Davis ..... A43B 21/52  
 D765,371 S \* 9/2016 Tæstensen ..... D2/950  
 D765,954 S \* 9/2016 Sassi ..... D2/929  
 D772,544 S \* 11/2016 Slimane ..... D2/939  
 D773,158 S \* 12/2016 Slimane ..... D2/930  
 D774,737 S \* 12/2016 Sassi ..... D2/929  
 D775,797 S \* 1/2017 Sassi ..... D2/929  
 9,775,399 B2 \* 10/2017 Green ..... A43B 13/04  
 9,781,973 B2 \* 10/2017 Singh ..... A43B 7/30

D827,993 S \* 9/2018 Sassi ..... D2/929  
 D827,995 S \* 9/2018 Birman ..... D2/929  
 2018/0317604 A1 \* 11/2018 Duarte ..... A43B 21/42

OTHER PUBLICATIONS

Shoes transform from flats to heels in seconds, YouTube.com, Mime et moi, Published on May 2, 2017, [online], [site visited Dec. 29, 2018]. <URL: <https://www.youtube.com/watch?v=X0jbpiZhANA>> (Year: 2017).\*

High-tech heels transform into flats with the push of a button, NYpost.com, By Lisa Fickenscher, Nov. 15, 2017, [online], [site visited Dec. 29, 2018]. <URL: <https://nypost.com/2017/11/15/high-tech-heels-transform-into-flats-with-the-push-of-a-button/>> (Year: 2017).\*

Runway Heels, The only pair you need, RunwayHeels.com, [online], [site visited Dec. 29, 2018]. <URL: <https://www.runwayheels.com/>> (Year: 2018).\*

High-toFlat Heels by Karely, YouTube.com, Cinthis Estrada, Published on Oct. 31, 2017, [online], [site visited Dec. 29, 2018]. <URL: <https://www.youtube.com/watch?v=jIk60gJhxR8>> (Year: 2017).\*

\* cited by examiner

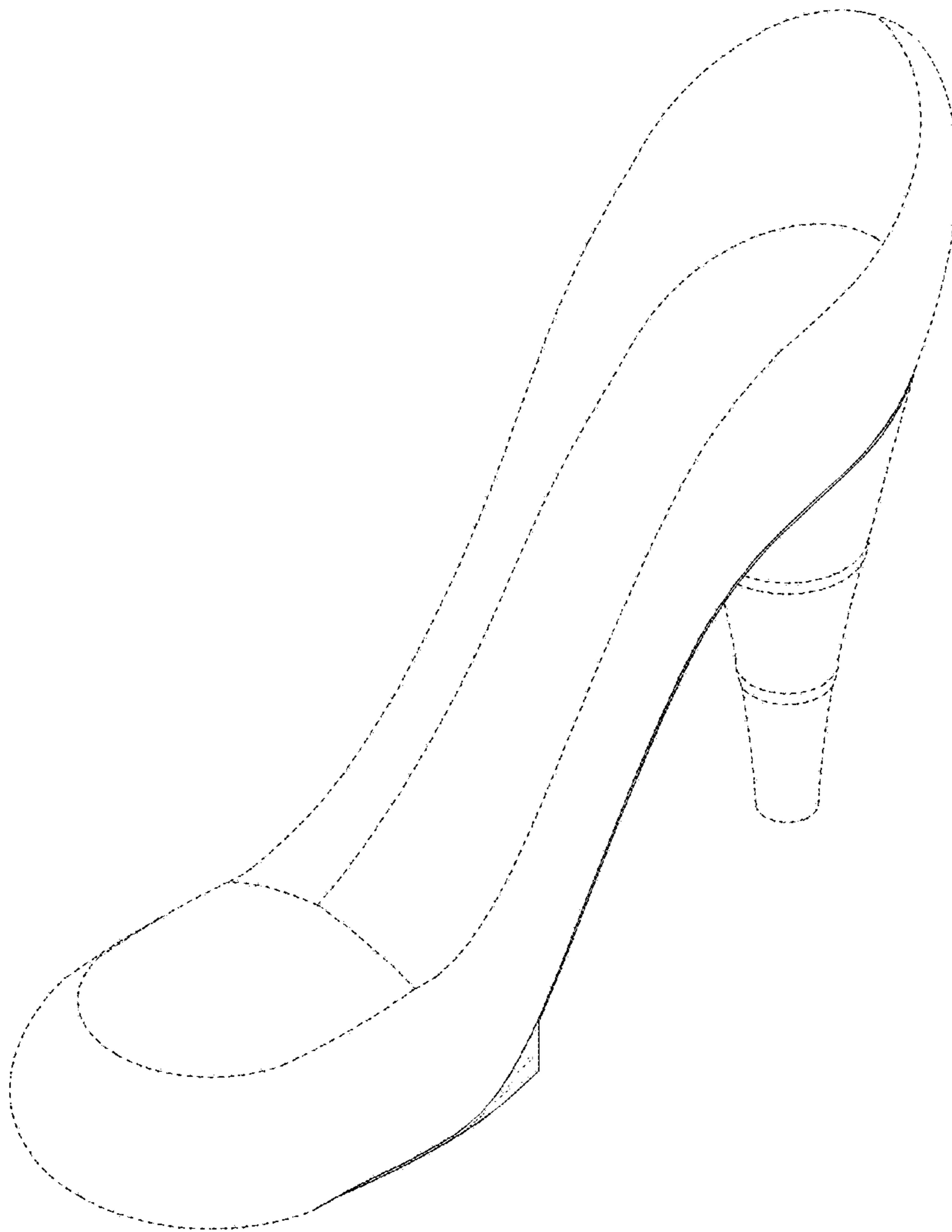

FIG. 1

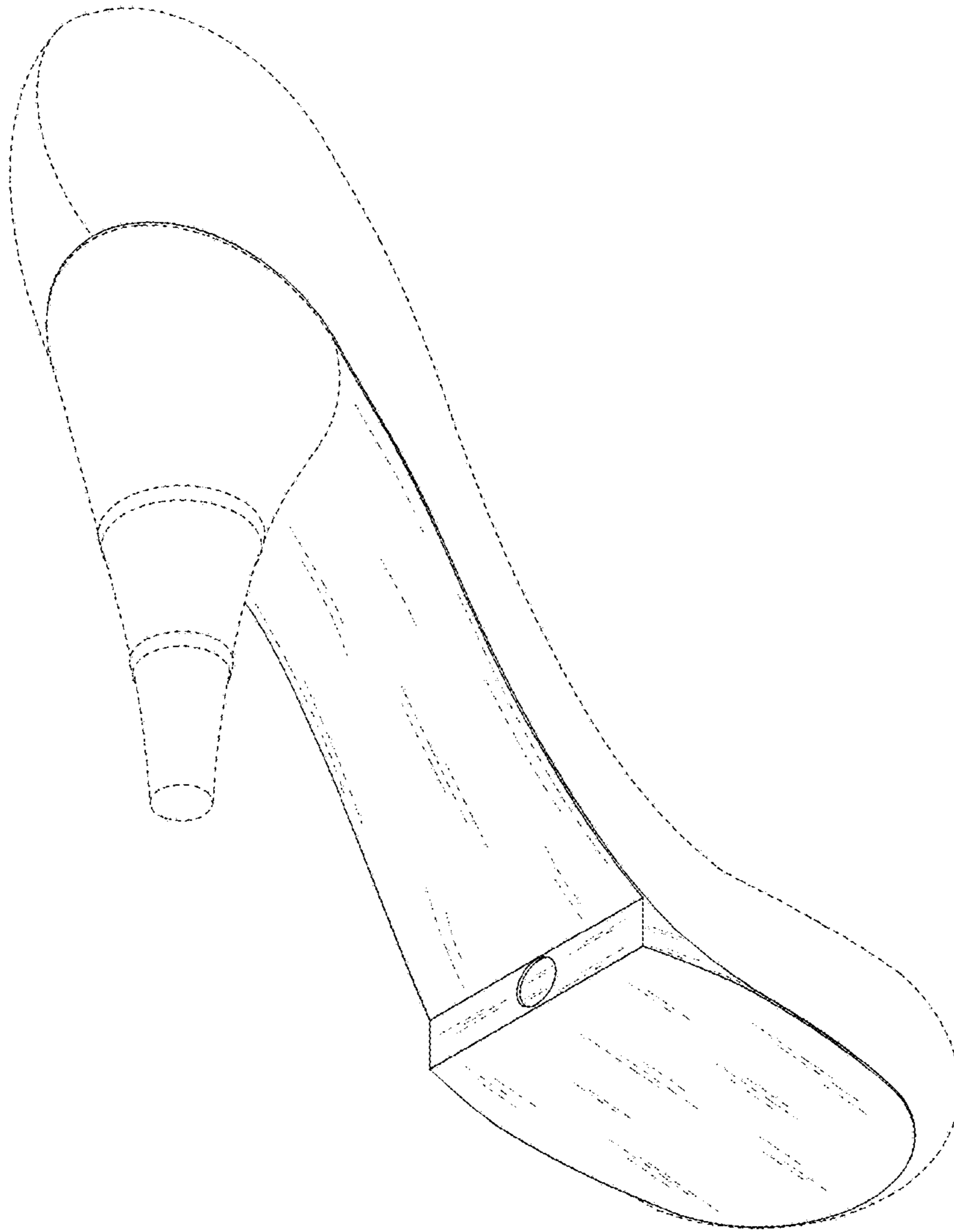

FIG. 2

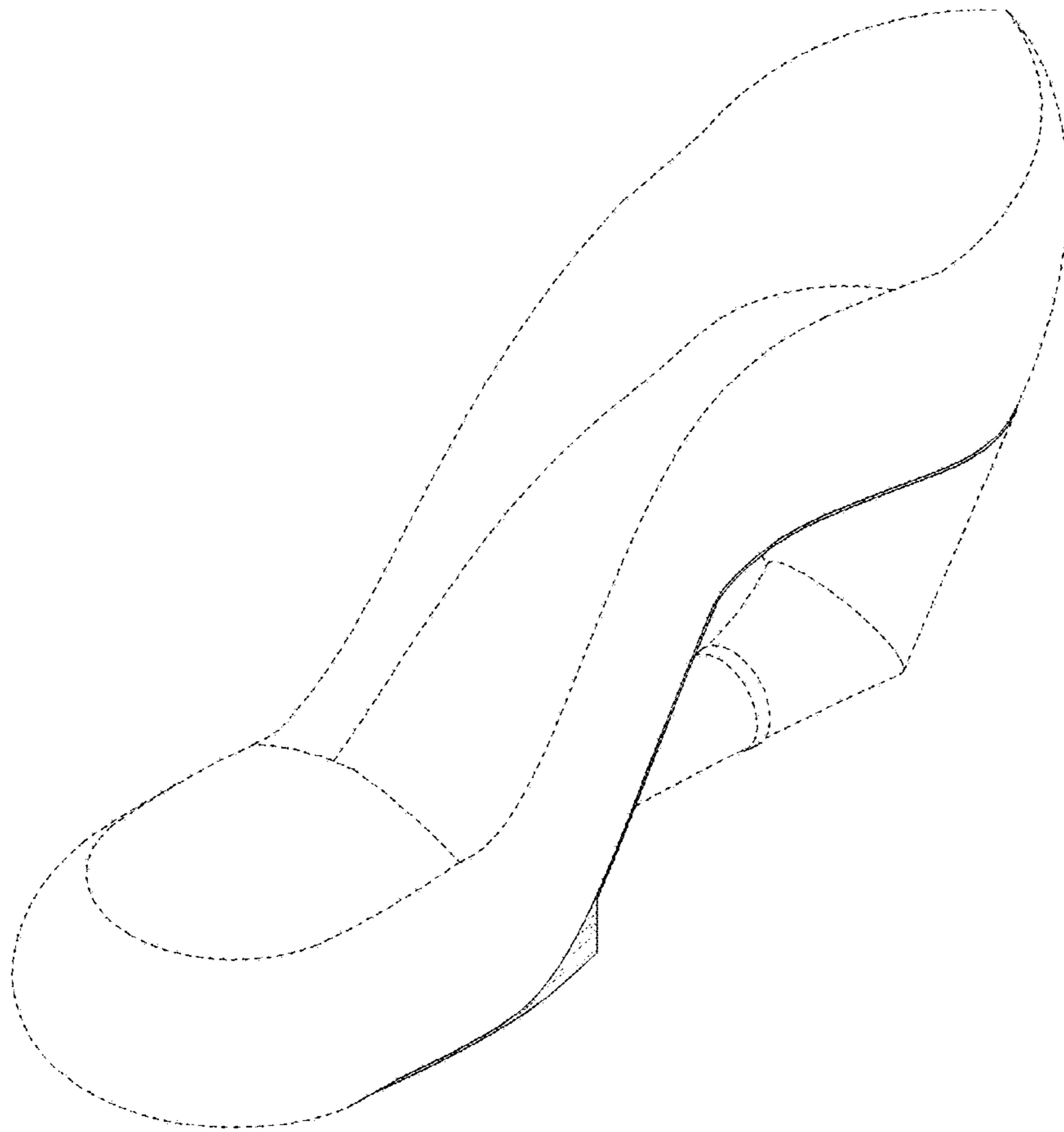

FIG. 3

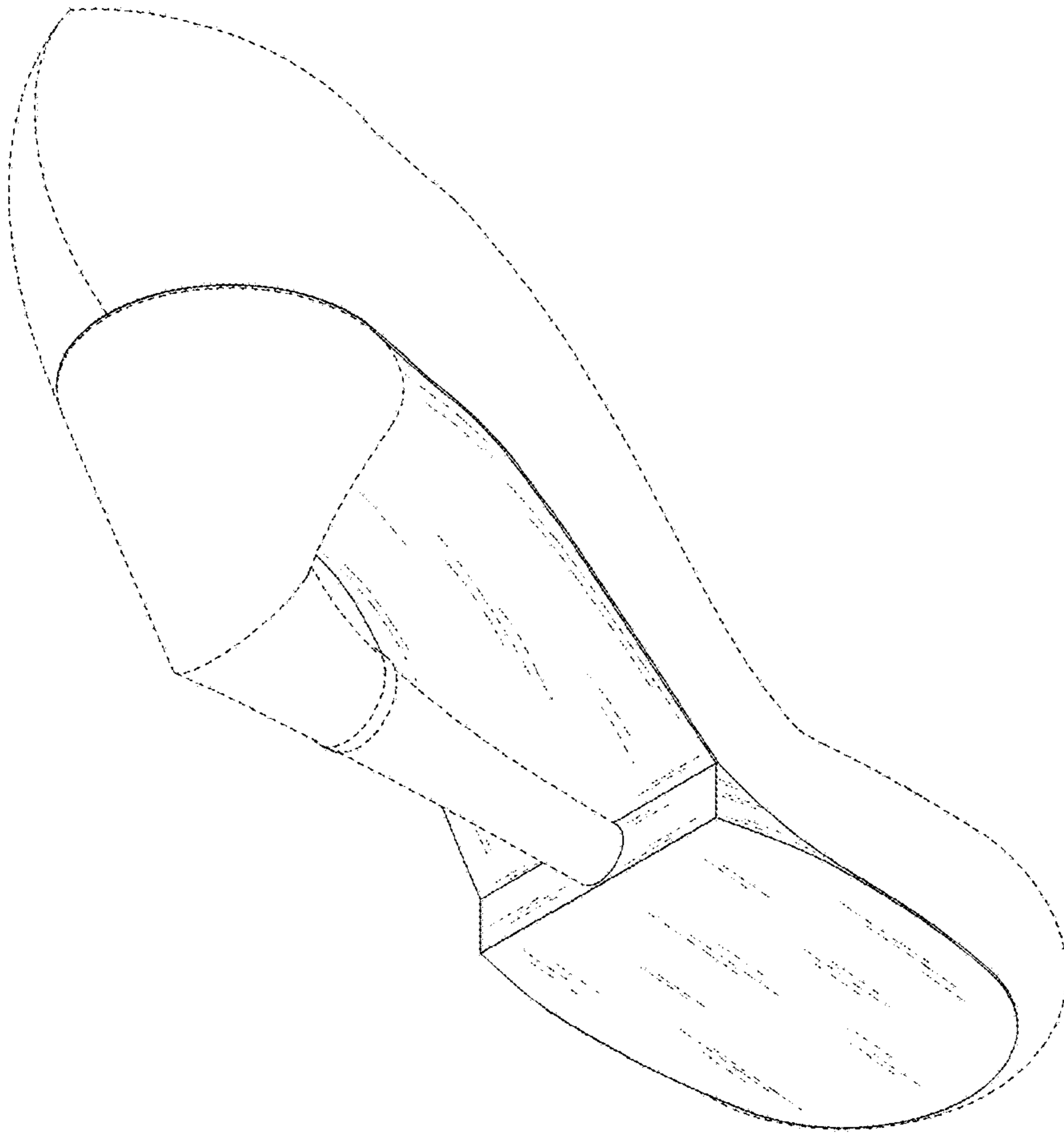

FIG. 4

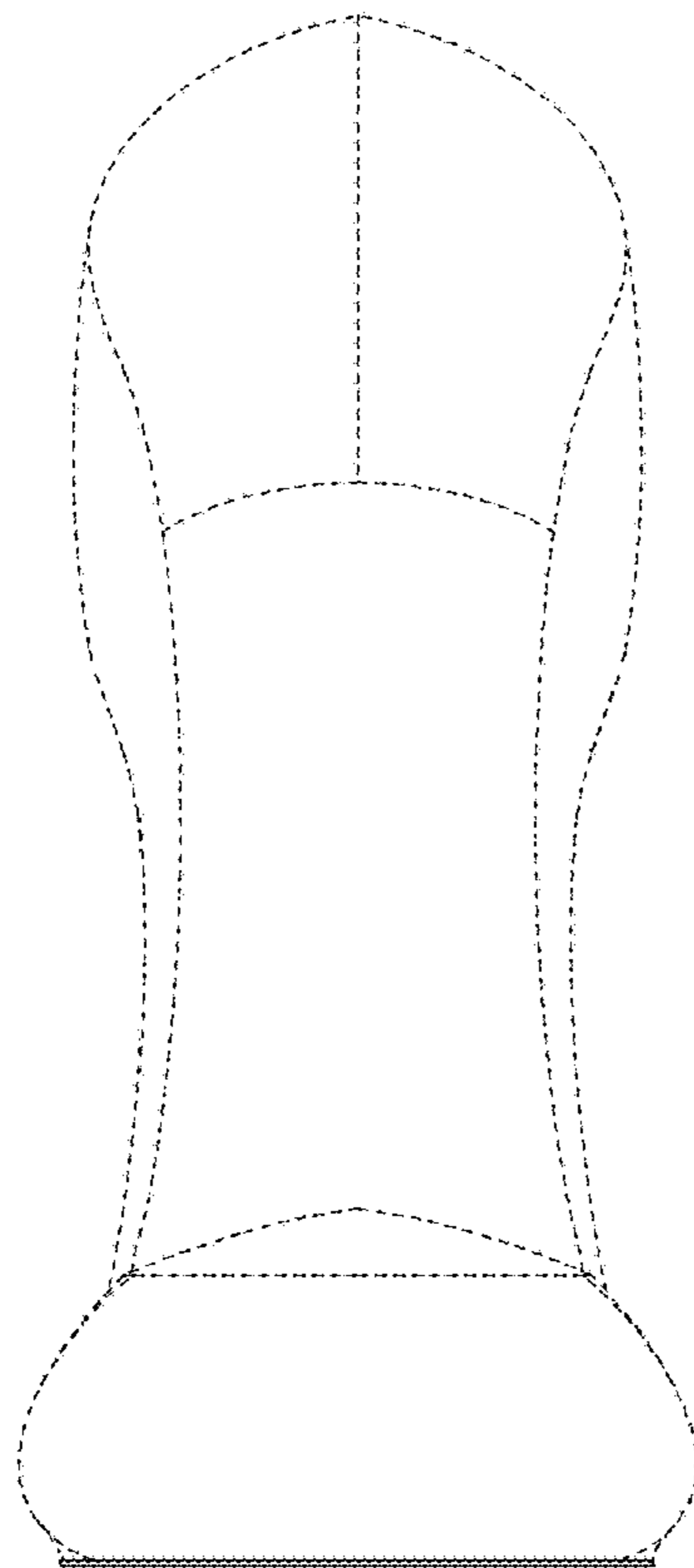

FIG. 5



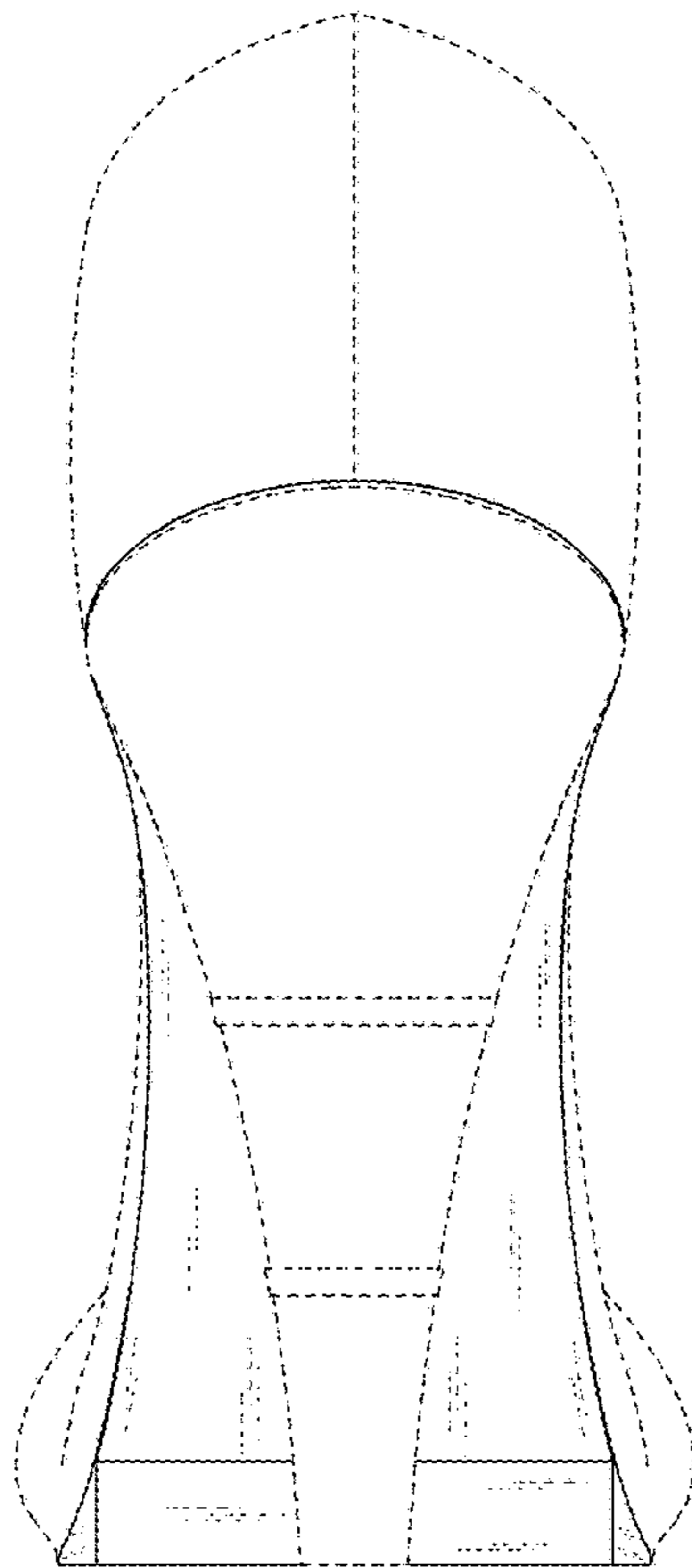

FIG. 6



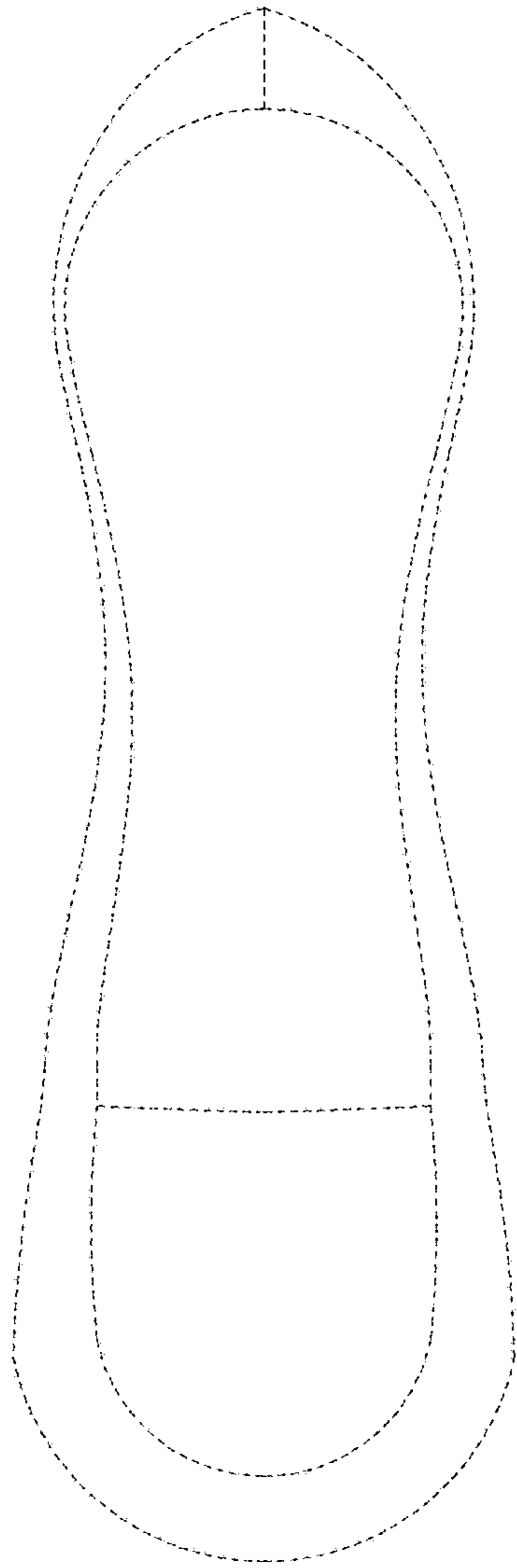

FIG. 7

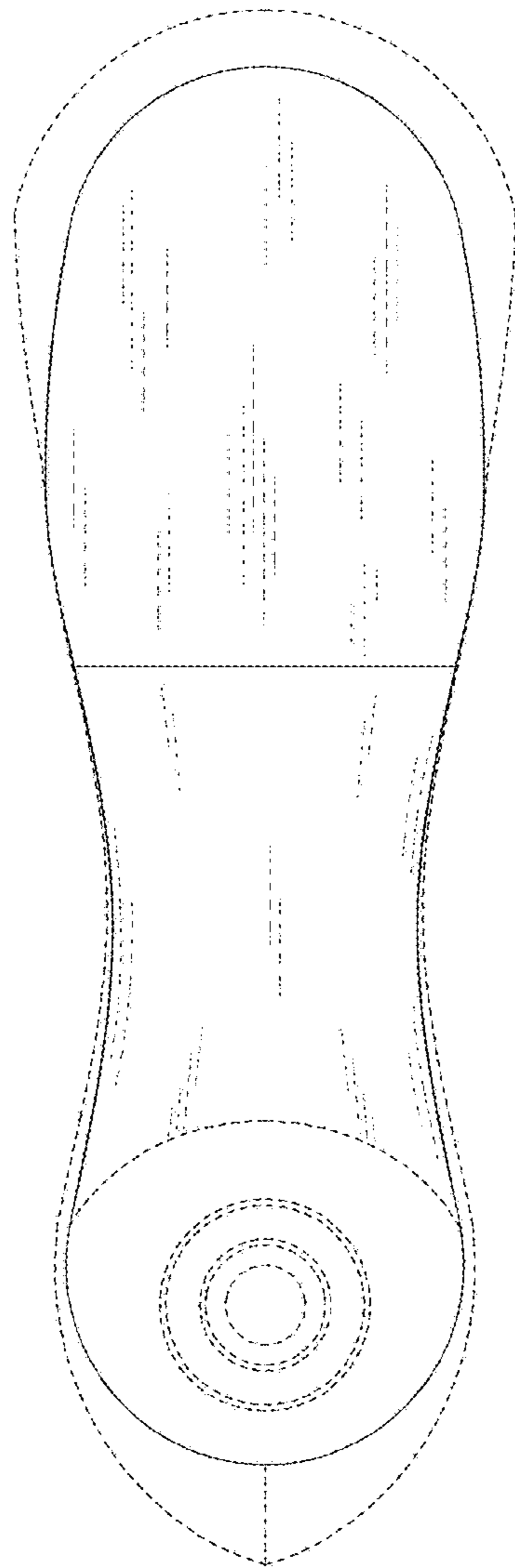

FIG. 8

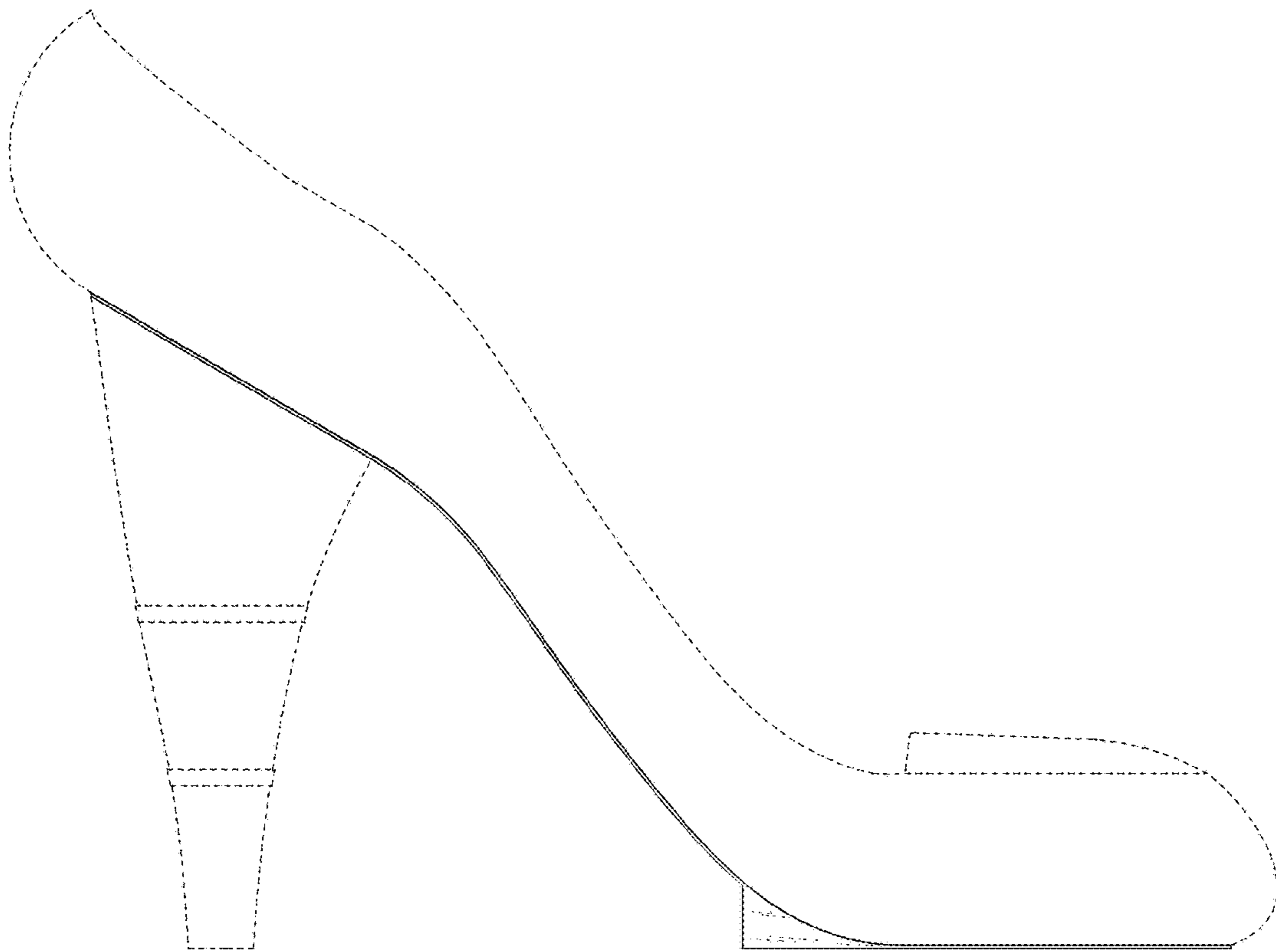

FIG. 9

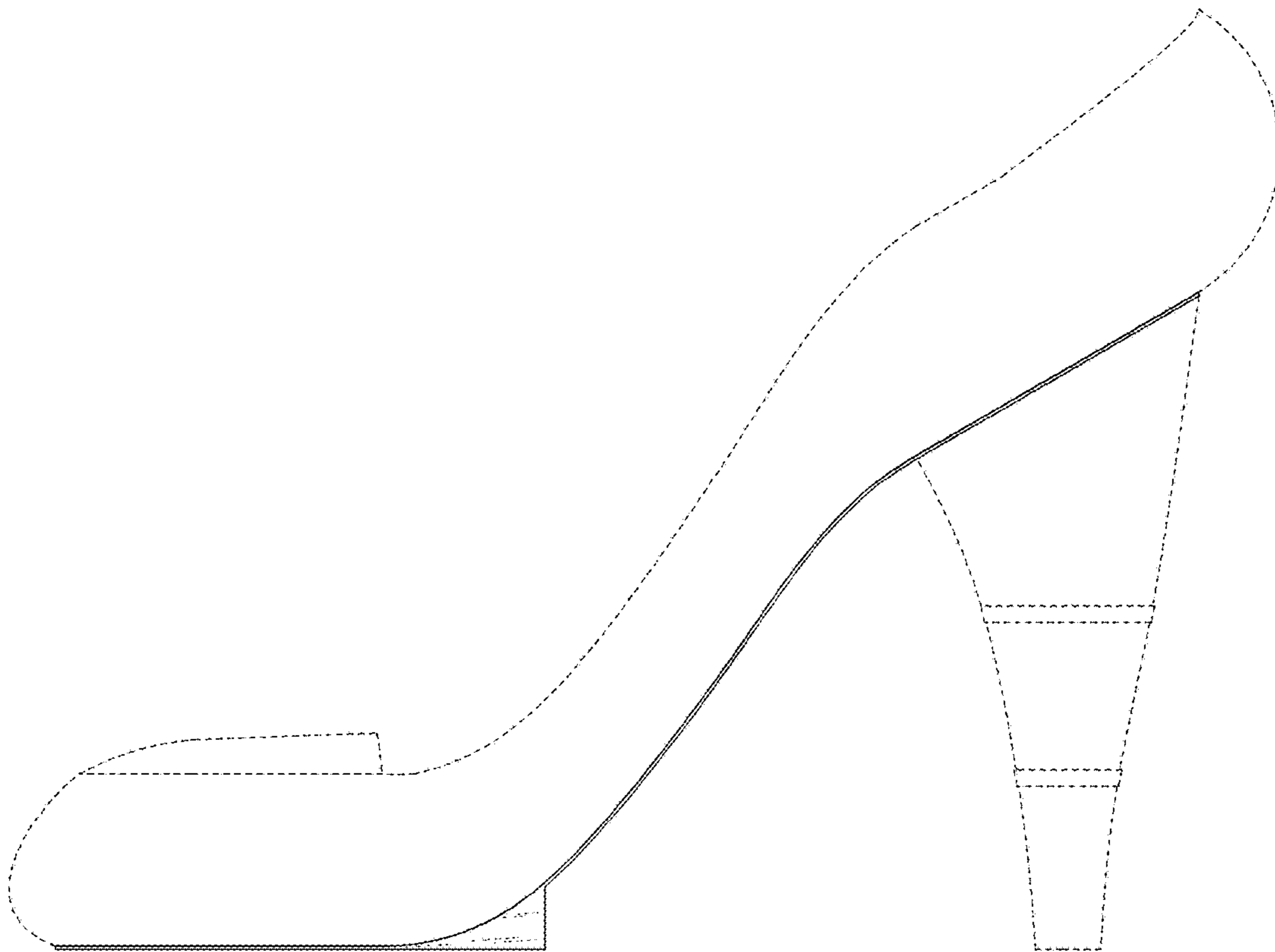

FIG. 10