



US00D861964S

(12) **United States Design Patent**
Lin

(10) **Patent No.:** **US D861,964 S**

(45) **Date of Patent:** **** Oct. 1, 2019**

(54) **STARRY SKY PROJECTOR LAMP**

D731,578 S 6/2015 Johnson
D815,335 S * 4/2018 Lin D26/110
D816,890 S 5/2018 Khubani
D819,146 S 5/2018 Villano et al.

(71) Applicant: **Ruikun Lin**, Shantou (CN)

(72) Inventor: **Ruikun Lin**, Shantou (CN)

* cited by examiner

(**) Term: **15 Years**

Primary Examiner — Brian N. Vinson

(21) Appl. No.: **29/686,910**

(57) **CLAIM**

The ornamental design for a starry sky projector lamp, as shown and described.

(22) Filed: **Apr. 9, 2019**

DESCRIPTION

(51) **LOC (12) Cl.** **26-03**

(52) **U.S. Cl.**
USPC **D26/110**

(58) **Field of Classification Search**
USPC D26/1, 24, 104, 105, 106, 108, 110, 111,
D26/112, 118, 124, 93; D11/131, 157,
D11/184, 121, 125
CPC .. A63H 13/00; F21S 6/00; F21S 6/002; F21S
10/00; F21V 3/00; F21V 3/0418; F21V
15/00; F21V 21/02; F21V 31/00; F21W
2121/00; F21W 2131/30
See application file for complete search history.

FIG. 1 is a first perspective view of a starry sky projector lamp showing my design;
FIG. 2 is a second perspective view thereof;
FIG. 3 is a front view thereof;
FIG. 4 is a back view thereof;
FIG. 5 is a left side view thereof;
FIG. 6 is a right side view thereof;
FIG. 7 is a top view thereof;
FIG. 8 is a bottom view thereof;
FIG. 9 is a first perspective view of an opened state of the starry sky projector lamp thereof; and,
FIG. 10 is a second perspective view of an opened state of the starry sky projector lamp thereof.
The broken lines shown in the drawings depict portions of the starry sky projector lamp in which the design is embodied that form no part of the claimed design.

(56) **References Cited**

U.S. PATENT DOCUMENTS

D478,681 S * 8/2003 Newcomb D26/110
D591,785 S * 5/2009 Fong D26/118
D670,852 S * 11/2012 Lin D26/104

1 Claim, 10 Drawing Sheets

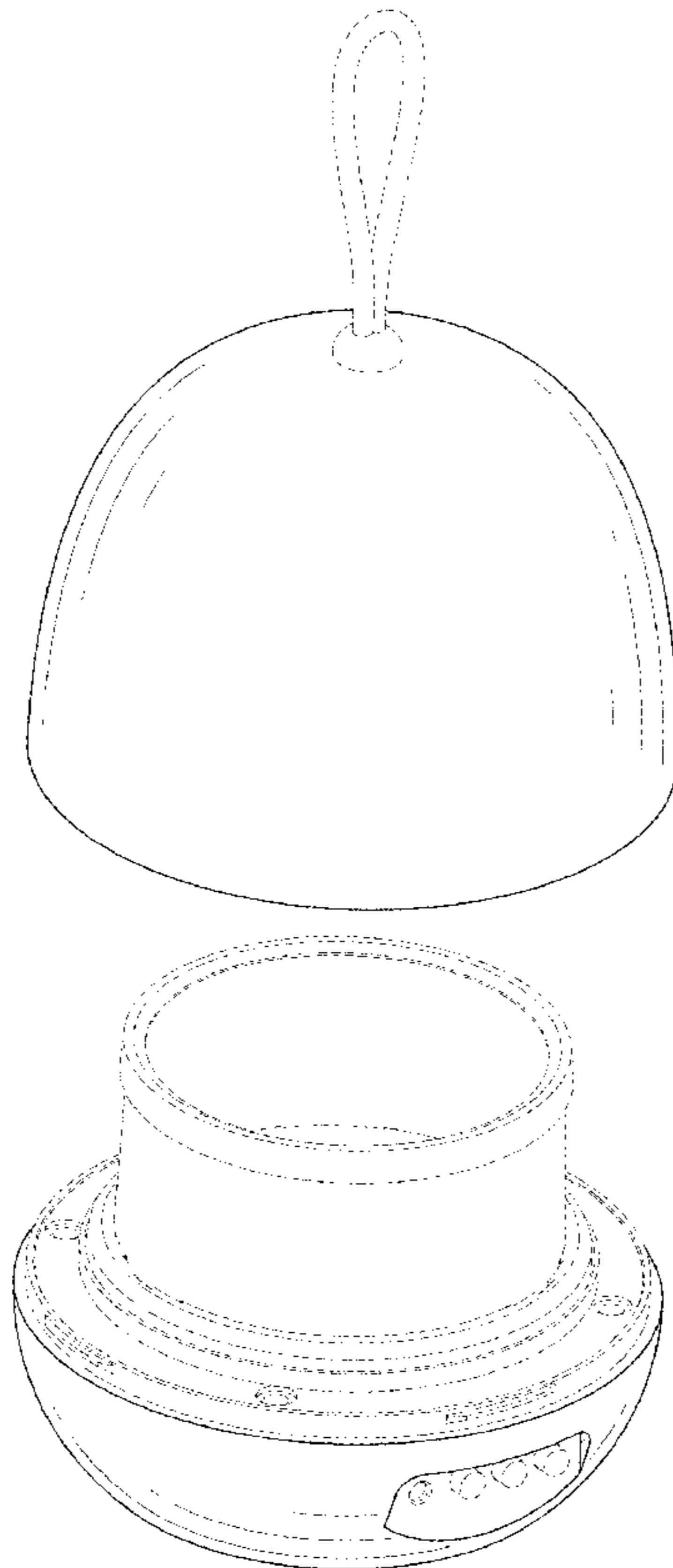

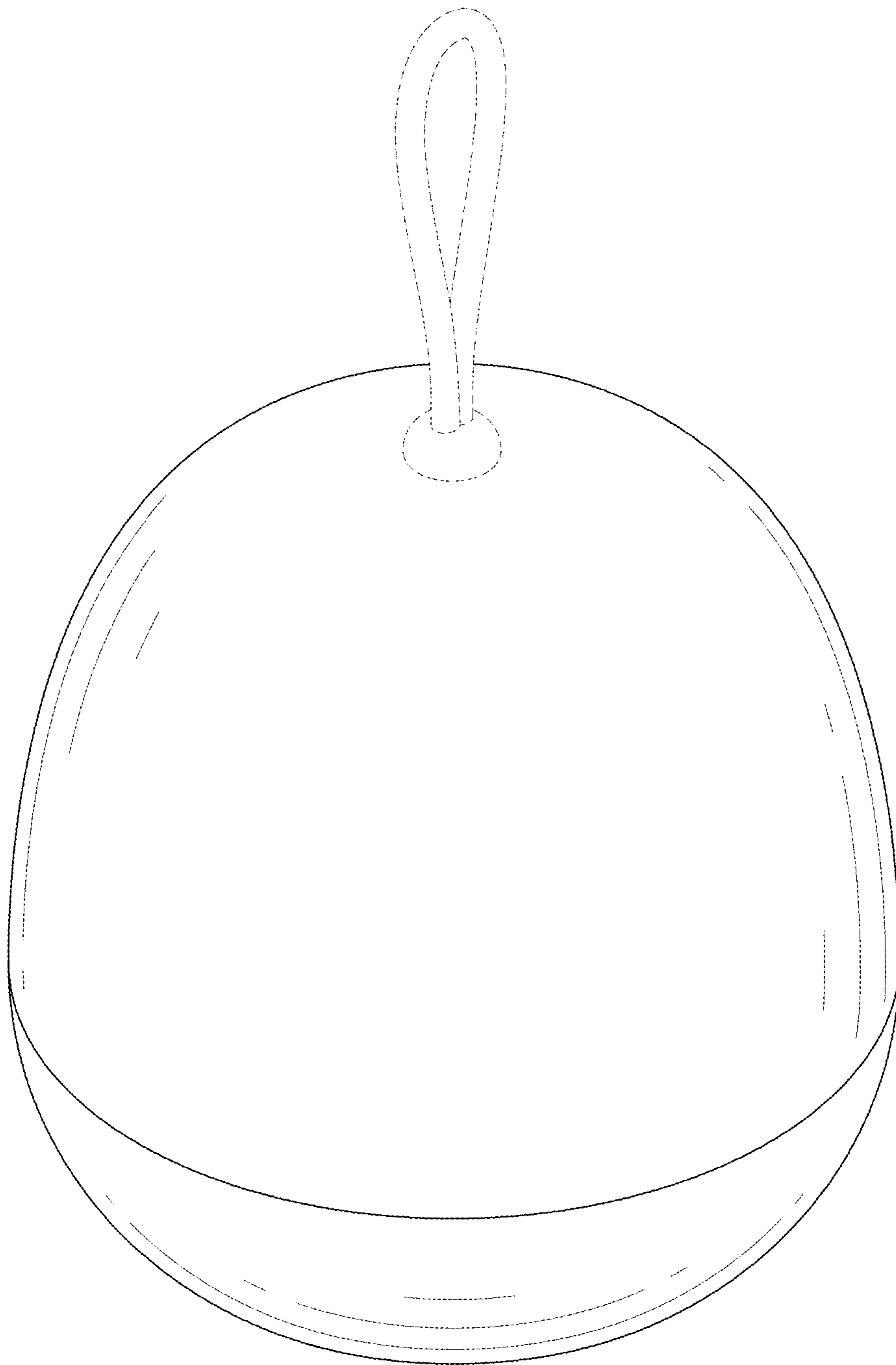

FIG. 1

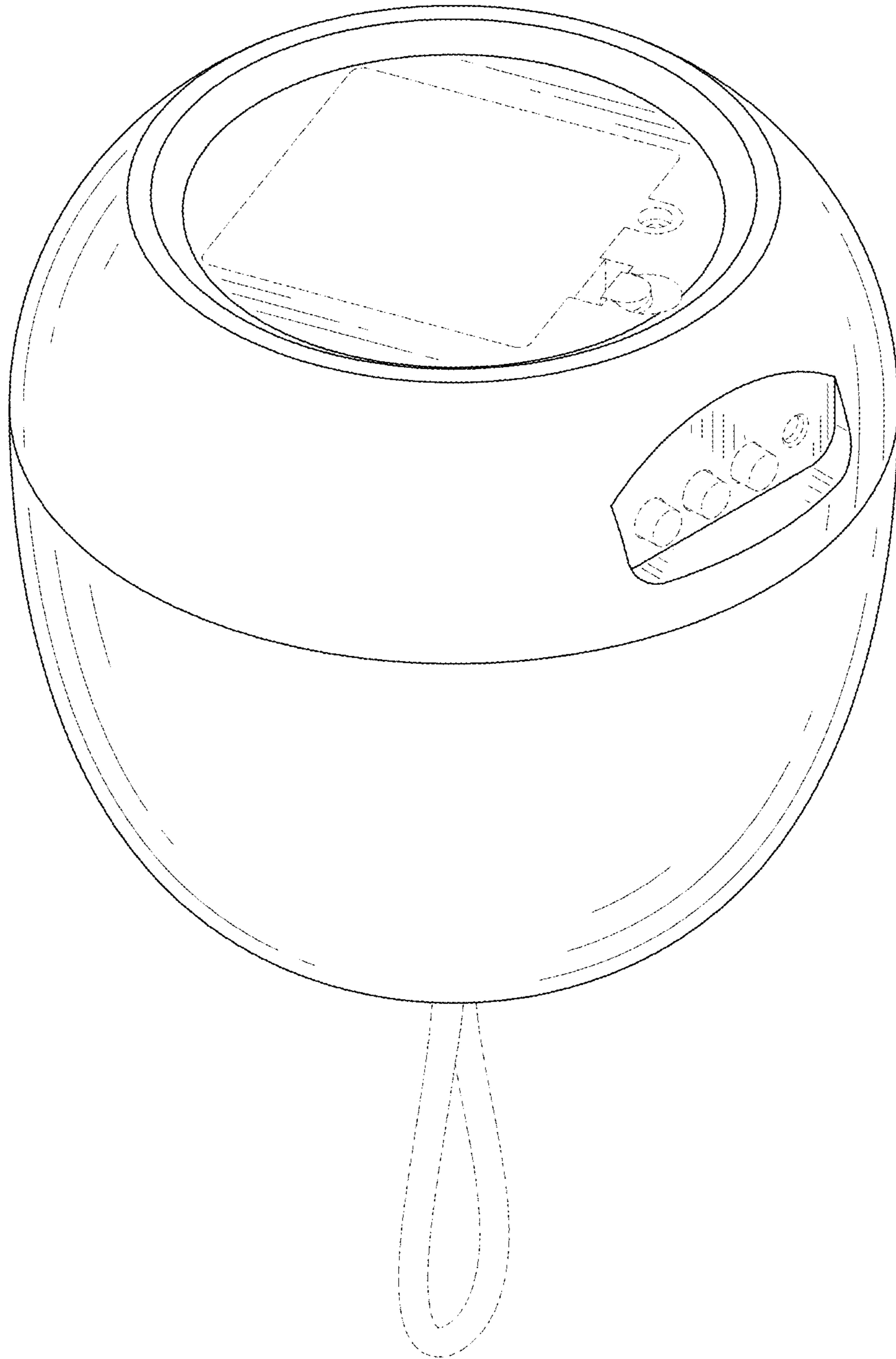

FIG. 2

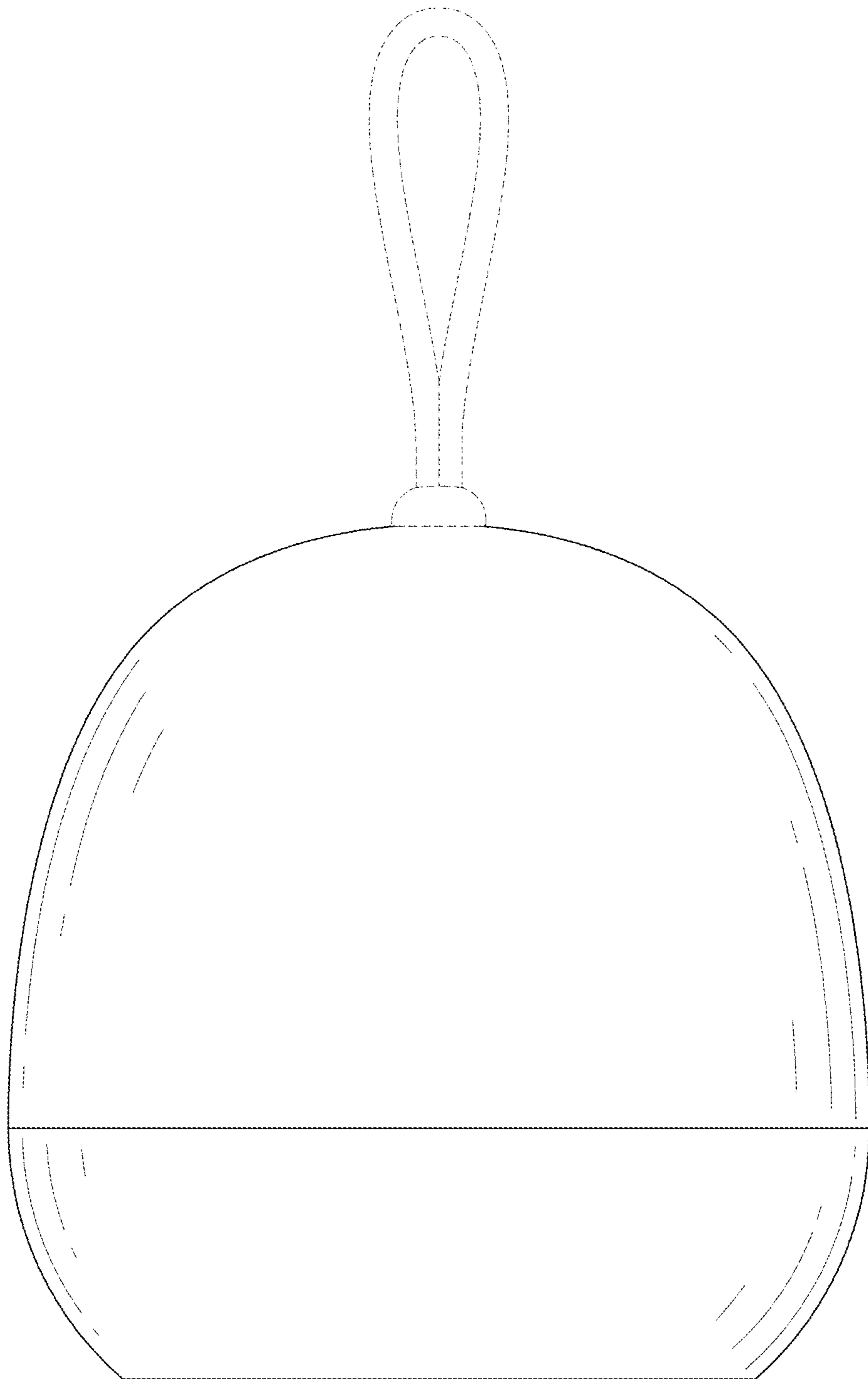

FIG. 3

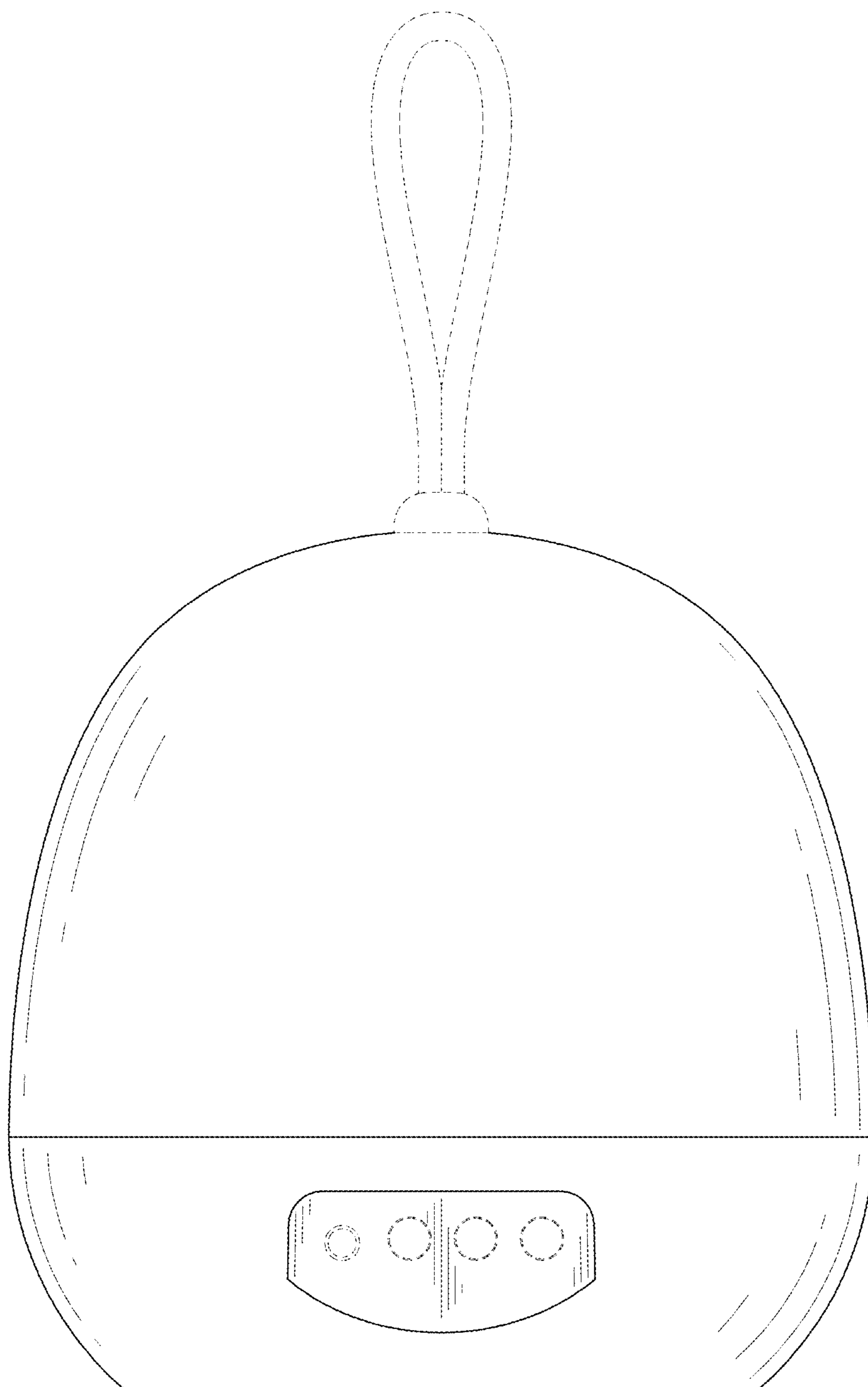

FIG. 4

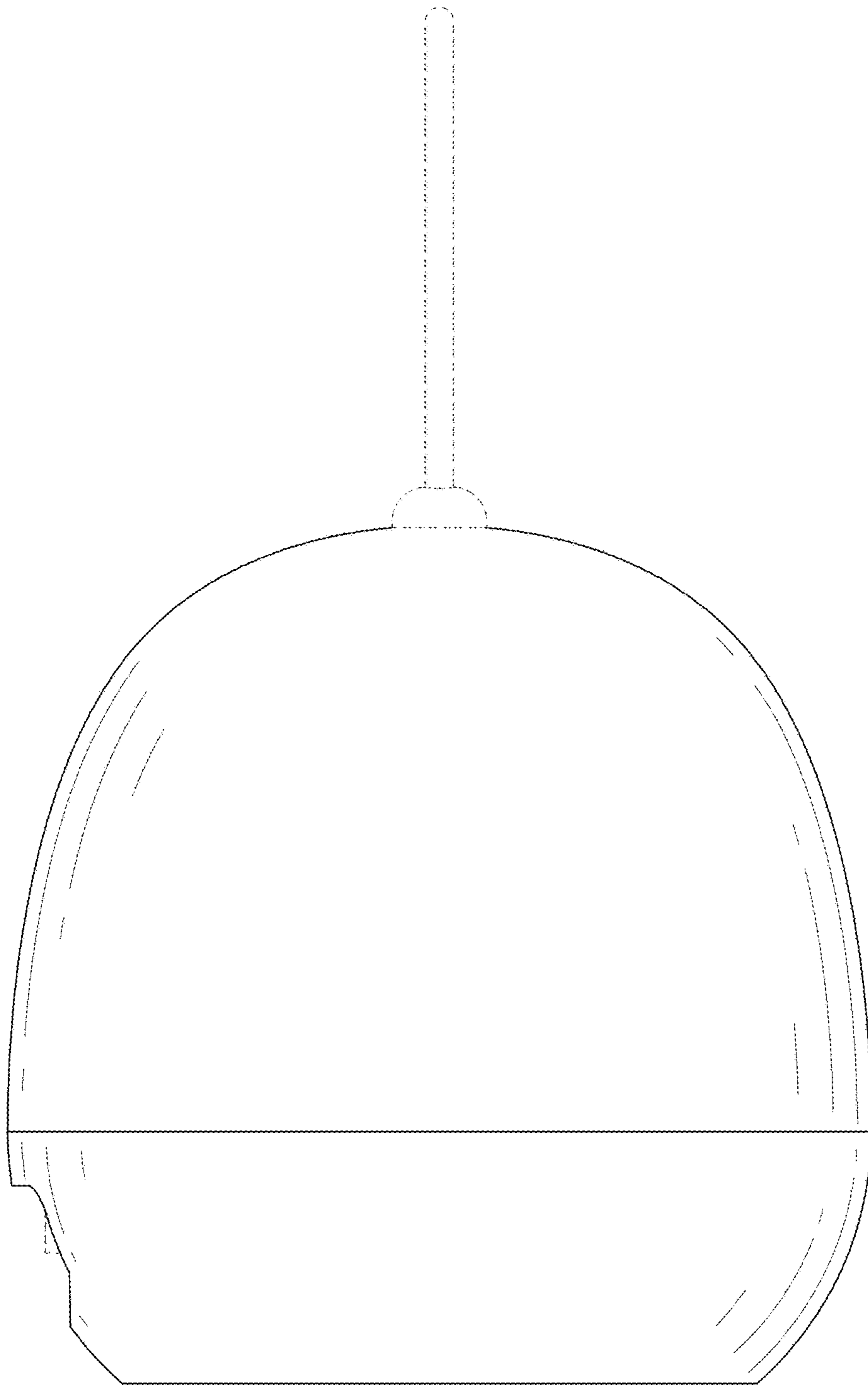

FIG. 5

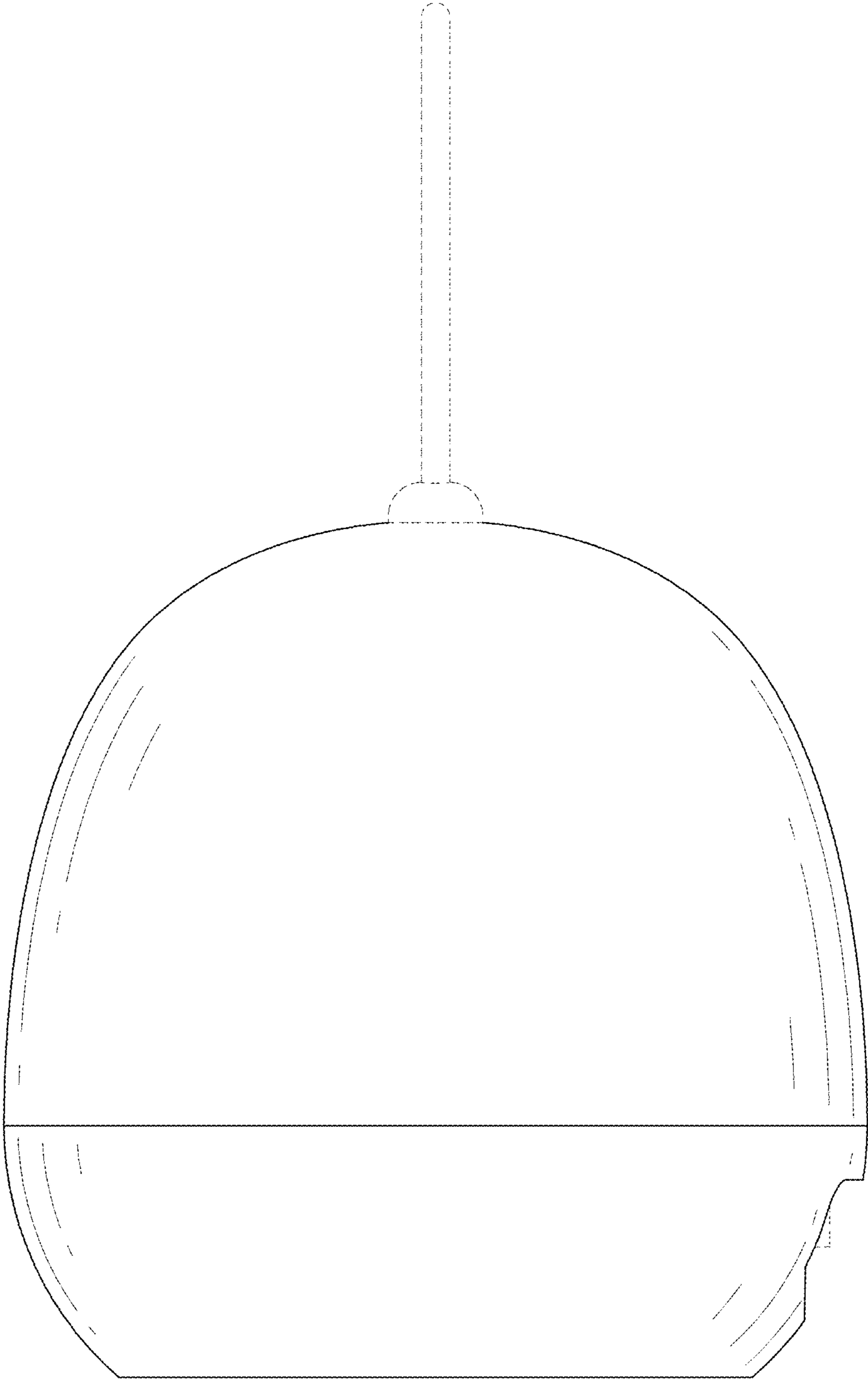

FIG. 6

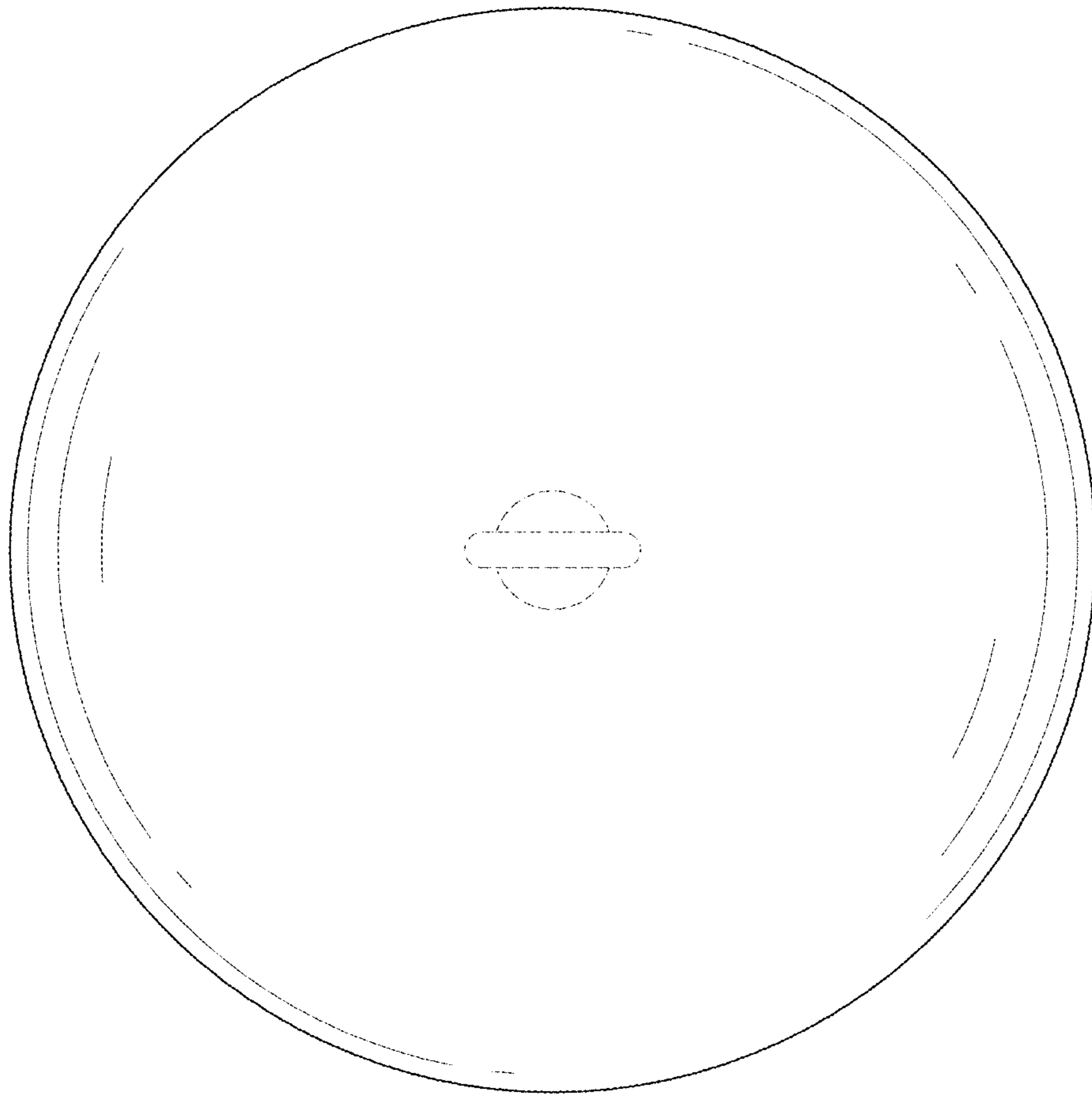

FIG. 7

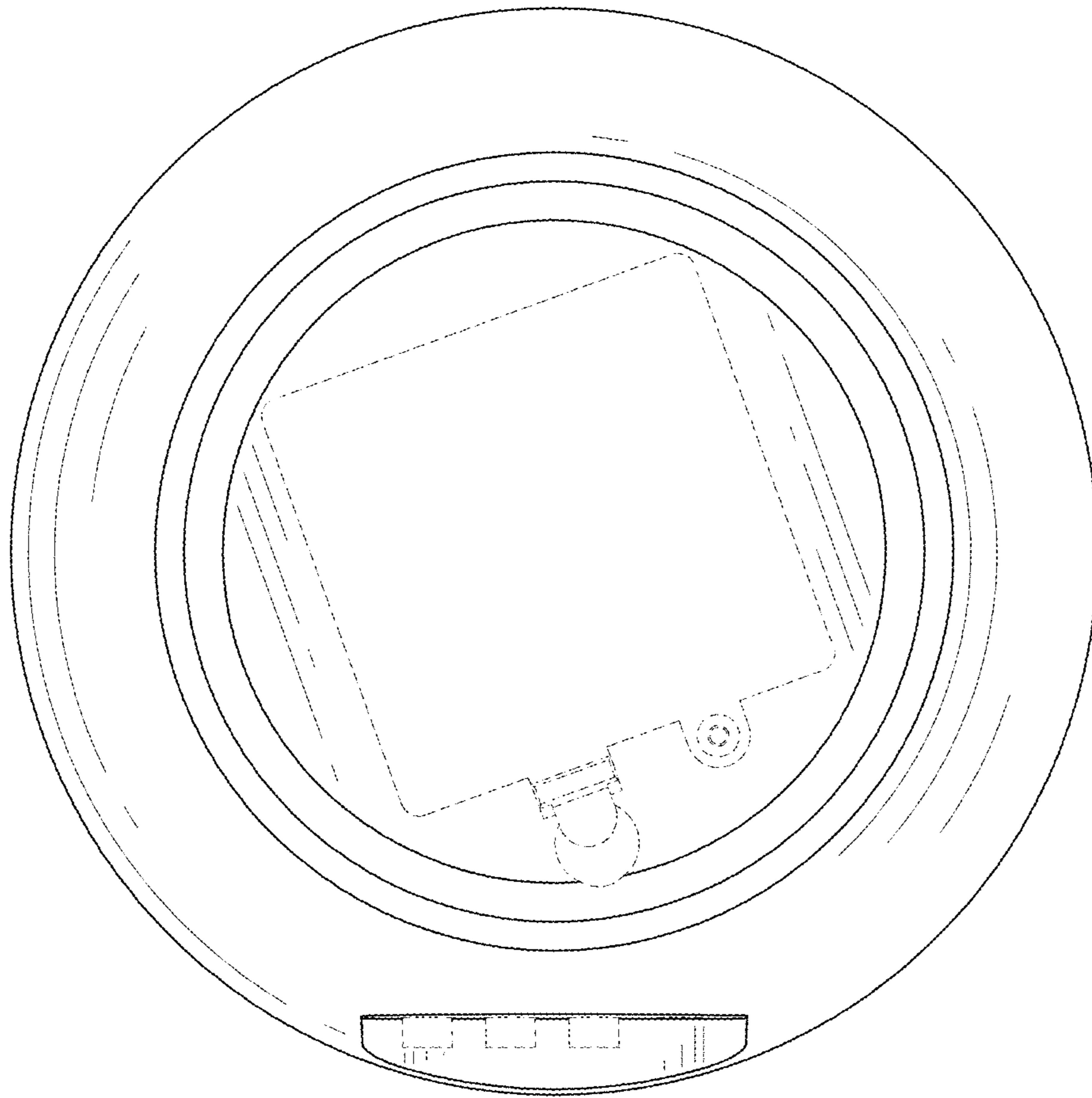

FIG. 8

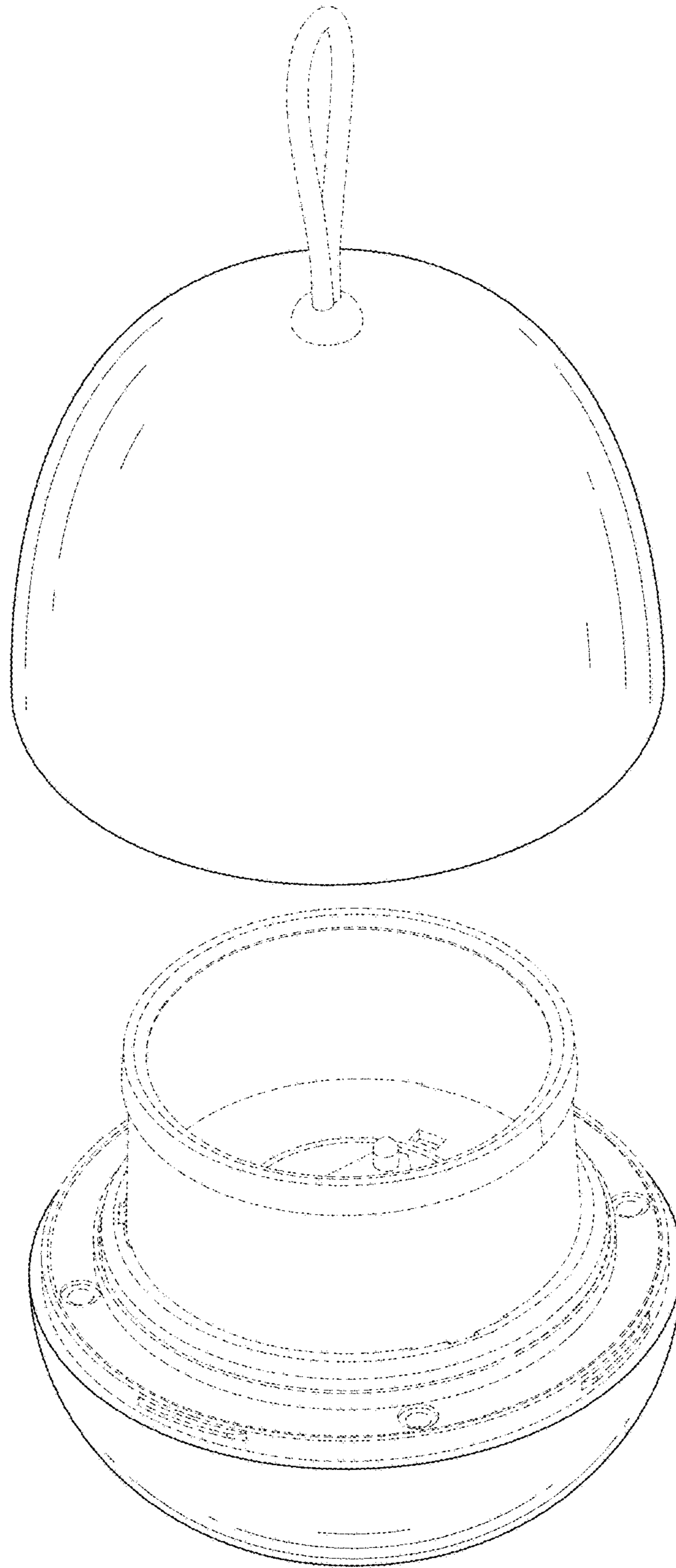

FIG. 9

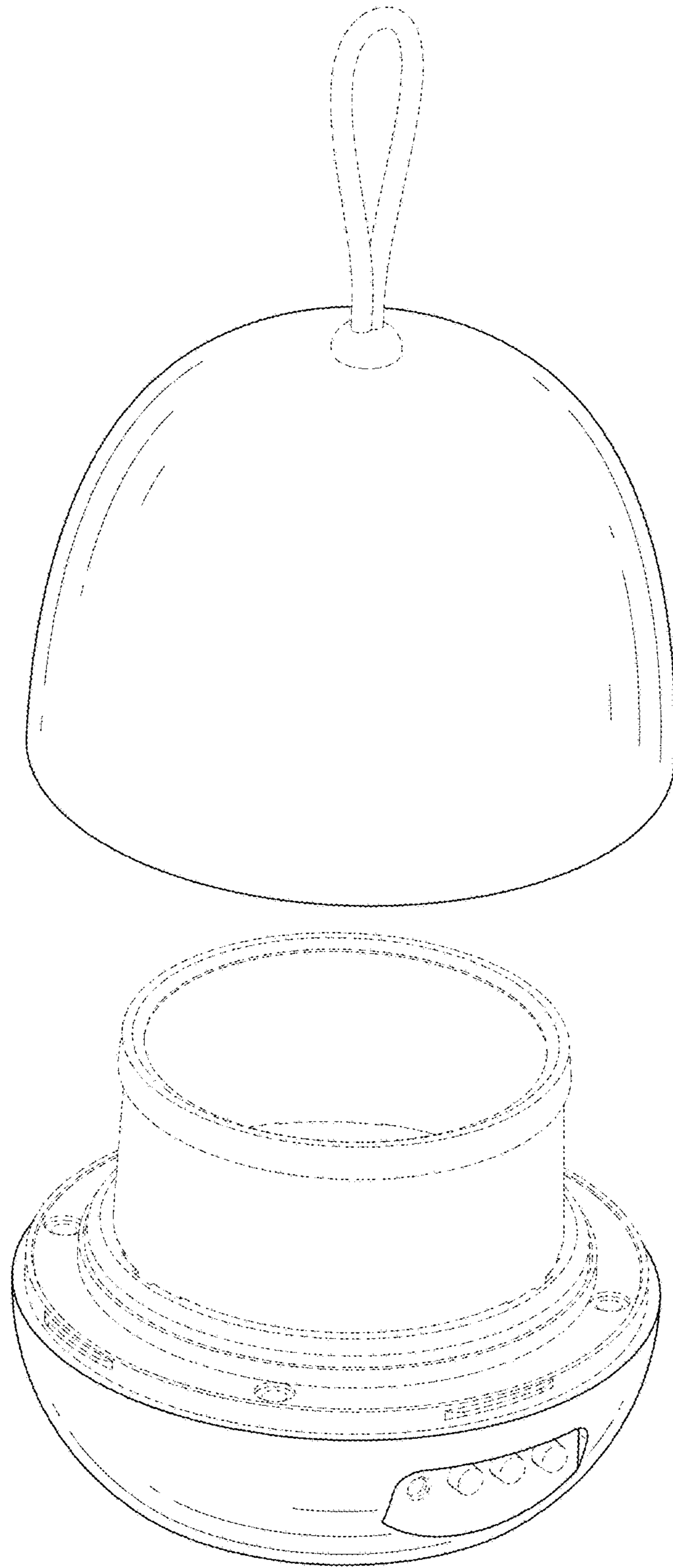

FIG. 10