

US00D861806S

(12) **United States Design Patent** (10) **Patent No.:** **US D861,806 S**  
**Arceta** (45) **Date of Patent:** **\*\* Oct. 1, 2019**

(54) <b>SUPPORT RACK FOR FREE WEIGHTS</b>	5,123,547 A *	6/1992 Koch	..... F16L 3/2235 211/59.4
(71) Applicant: <b>Brunswick Corporation</b> , Mettawa, IL (US)	D329,563 S	9/1992 Rasmussen	
	D333,522 S *	2/1993 Gianino	..... D24/229
	D333,687 S	3/1993 Smith	
(72) Inventor: <b>Radmond V. Arceta</b> , Libertyville, IL (US)	D362,776 S	10/1995 Thorn	
	D364,063 S	11/1995 Lo	
	D377,727 S *	2/1997 Fairweather	..... D6/552
	D380,115 S *	6/1997 Fairweather	..... D6/552
(73) Assignee: <b>Brunswick Corporation</b> , Mettawa, IL (US)	D424,141 S	5/2000 Eckmann	
	D455,310 S	4/2002 Webber	
	D469,293 S	1/2003 Harms	
	D469,294 S	1/2003 Harms et al.	
(**) Term: <b>15 Years</b>	6,527,682 B1	3/2003 Gomez	

(Continued)

(21) Appl. No.: **29/684,923**

(22) Filed: **Mar. 25, 2019**

**Related U.S. Application Data**

(62) Division of application No. 29/621,163, filed on Oct. 5, 2017.

(51) **LOC (12) Cl.** ..... **21-02**

(52) **U.S. Cl.**  
USPC ..... **D21/686**

(58) **Field of Classification Search**  
USPC ..... 482/62, 94, 98, 104, 107, 108, 133, 135,  
482/142, 148, 908; D21/673, 684, 686,  
D21/690, 691, 694; D6/329, 552, 682.4;  
D7/701

CPC ..... F16L 3/2235; A63B 71/0036; A63B 1/00;  
A63B 21/0724; A63B 21/00069; A47F  
5/0846

See application file for complete search history.

(56) **References Cited**

**U.S. PATENT DOCUMENTS**

D164,503 S *	9/1951 Kerr	..... 211/14
D180,106 S *	4/1957 Seifert	..... 211/70.6
D271,903 S *	12/1983 Kaufman	..... D24/229
D318,767 S	8/1991 Schneider	
D319,361 S	8/1991 Moser	

**FOREIGN PATENT DOCUMENTS**

WO 2006/069421 7/2006

*Primary Examiner* — Susan E Krakower

*Assistant Examiner* — Michael A Maharajh

(74) *Attorney, Agent, or Firm* — Andrus Intellectual Property Law, LLP

(57) **CLAIM**

The ornamental design for a support rack for free weights, as shown and described.

**DESCRIPTION**

FIG. 1 is a perspective view of a support rack for free weights, showing my new design; FIG. 2 is a right side view thereof; FIG. 3 is a left side view thereof; FIG. 4 is a front view thereof; FIG. 5 is a rear view thereof; FIG. 6 is a top view thereof; and, FIG. 7 is a bottom view.

The broken lines shown in the figures are for the purpose of illustrating portions of the support rack for free weights, which form no part of the claimed design.

**1 Claim, 6 Drawing Sheets**

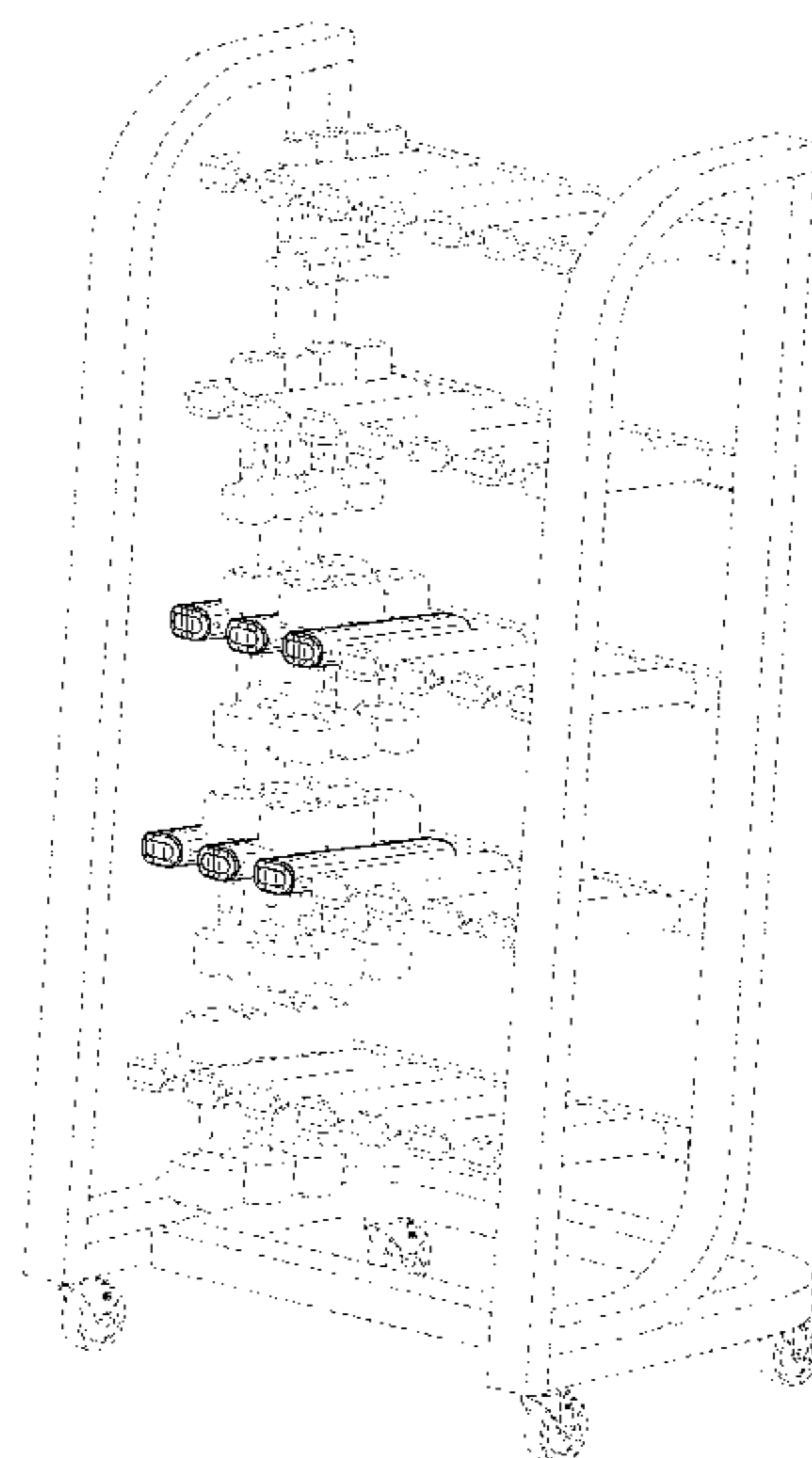

# US D861,806 S

Page 2

(56)

## References Cited

### U.S. PATENT DOCUMENTS

6,599,222 B2 *	7/2003	Wince .....	A63B 21/0724	482/106	8,479,930 B1	7/2013	Cohen	
D492,742 S	7/2004	Harms			D708,494 S *	7/2014	Carpenter .....	D7/701
D492,748 S	7/2004	Harms			8,790,225 B2 *	7/2014	Mayes .....	A63B 21/00069
D493,056 S	7/2004	Shomak						482/127
D506,516 S	6/2005	Yang			D722,845 S	2/2015	Lesage	
D514,354 S	2/2006	Nix et al.			D725,937 S	4/2015	Hendricks	
7,022,053 B2	4/2006	Whetstone			9,028,380 B2 *	5/2015	Hoole .....	A63B 21/0552
7,029,425 B2	4/2006	Krull						482/121
D528,612 S	9/2006	Black			90,028,380	5/2015	Hoole	
7,112,163 B2	9/2006	Krull			D739,189 S *	9/2015	Carpenter .....	D7/701
D533,743 S	12/2006	Eastman			D756,153 S	5/2016	LeFevre	
D536,562 S	2/2007	Widerman et al.			9,409,049 B1	8/2016	Brunelo et al.	
D553,453 S	10/2007	Toth			D772,356 S	11/2016	Gregory	
D557,541 S *	12/2007	Corbell .....	D6/552		D785,418 S *	5/2017	Carpenter .....	D7/701
D560,089 S	1/2008	DeMeyer			D788,234 S	5/2017	Gregory	
D565,132 S	3/2008	Lien			D789,163 S *	6/2017	Nemoto .....	D7/701
D565,673 S	4/2008	Lien et al.			9,737,783 B2 *	8/2017	Doerr .....	A63B 71/0036
D573,827 S *	7/2008	Taggart .....	D6/552		D802,962 S	11/2017	Bauer	
D577,234 S	9/2008	Webber et al.			D804,593 S	12/2017	Leier	
D577,235 S *	9/2008	Blazer .....	D6/552		D806,808 S	1/2018	Gregory	
D579,252 S	10/2008	Savoie			D807,448 S *	1/2018	Tseng .....	D21/694
D603,637 S	11/2009	Anderson et al.			D834,900 S *	12/2018	Kasza .....	D7/701
7,699,756 B2 *	4/2010	Piane, Jr. ....	A63B 1/00	482/38	D839,694 S *	2/2019	Pollard .....	D7/701
					D850,543 S *	6/2019	Lau .....	D21/686
D630,395 S	1/2011	DiMartino			2005/0009671 A1	1/2005	Hummer, Jr.	
D634,145 S	3/2011	Lai			2007/0010381 A1	1/2007	Black	
8,323,159 B2	12/2012	Perry et al.			2009/0211996 A1	8/2009	Webber	
D677,504 S	3/2013	Childs			2013/0334155 A1 *	12/2013	Kasza .....	A47F 5/0846
8,394,004 B2	3/2013	Towley, III						211/75
					2014/0367351 A1	12/2014	Juen	
					2015/0258412 A1 *	9/2015	Doerr .....	A63B 71/0036
								482/93

\* cited by examiner

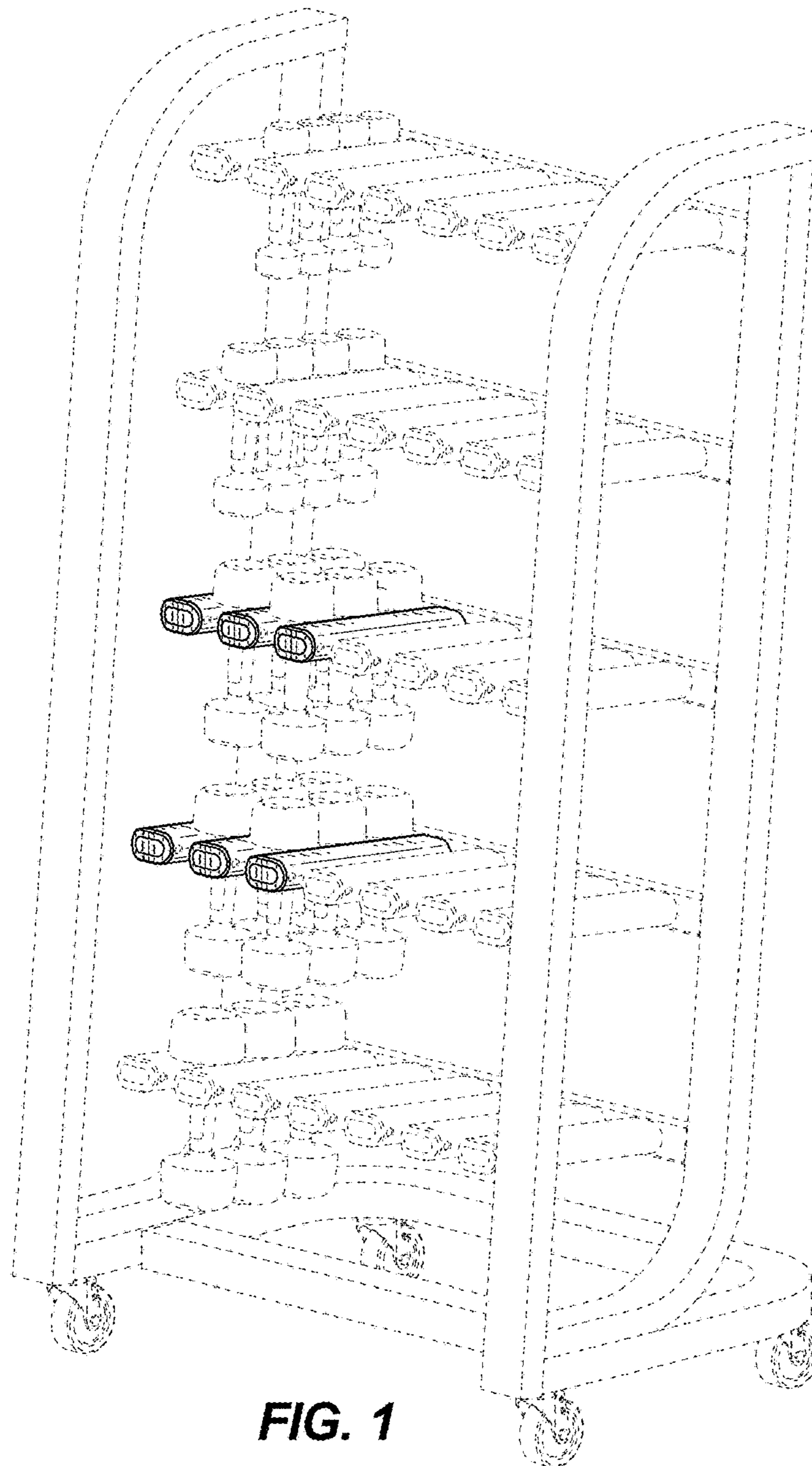

**FIG. 1**

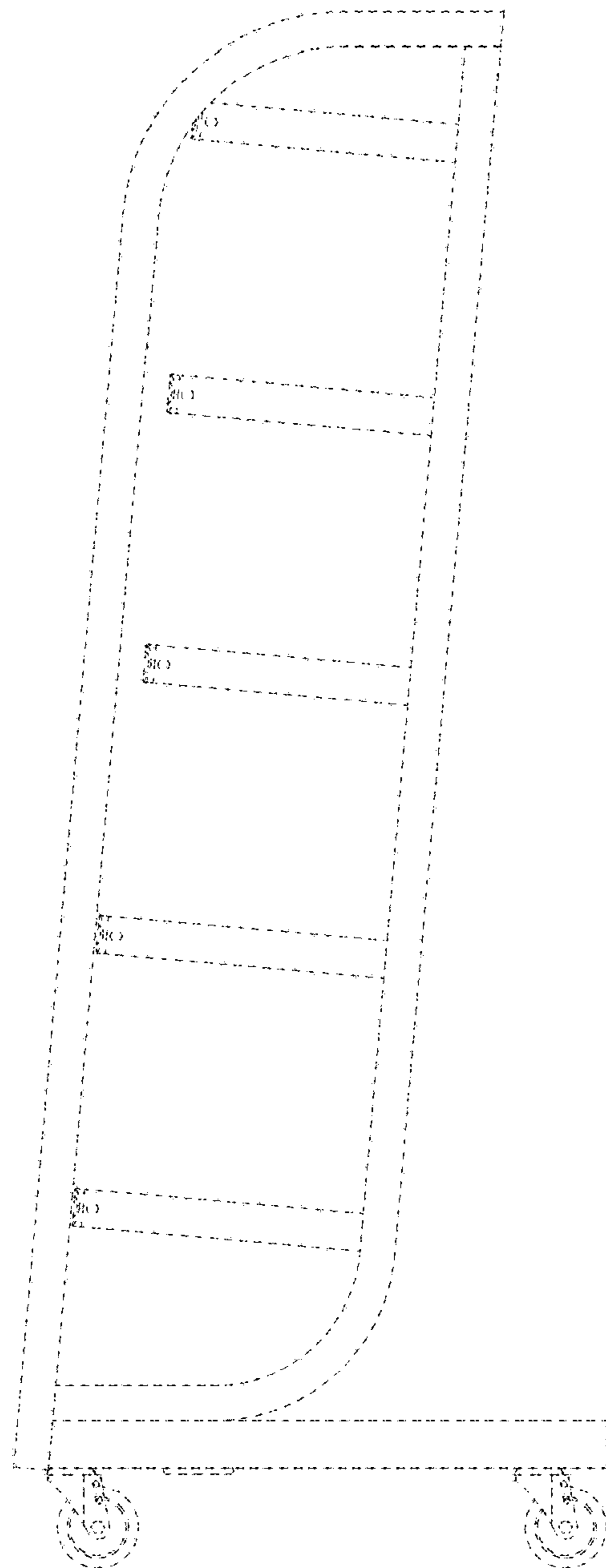

**FIG. 2**

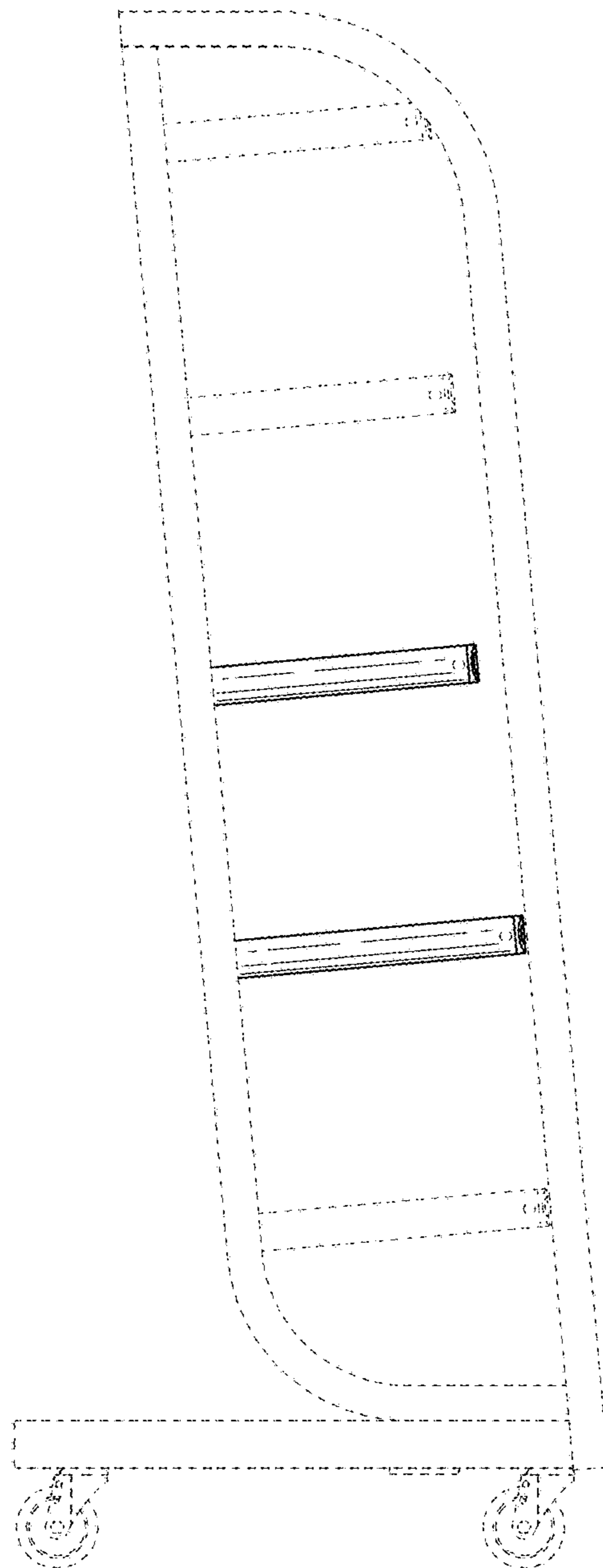

**FIG. 3**

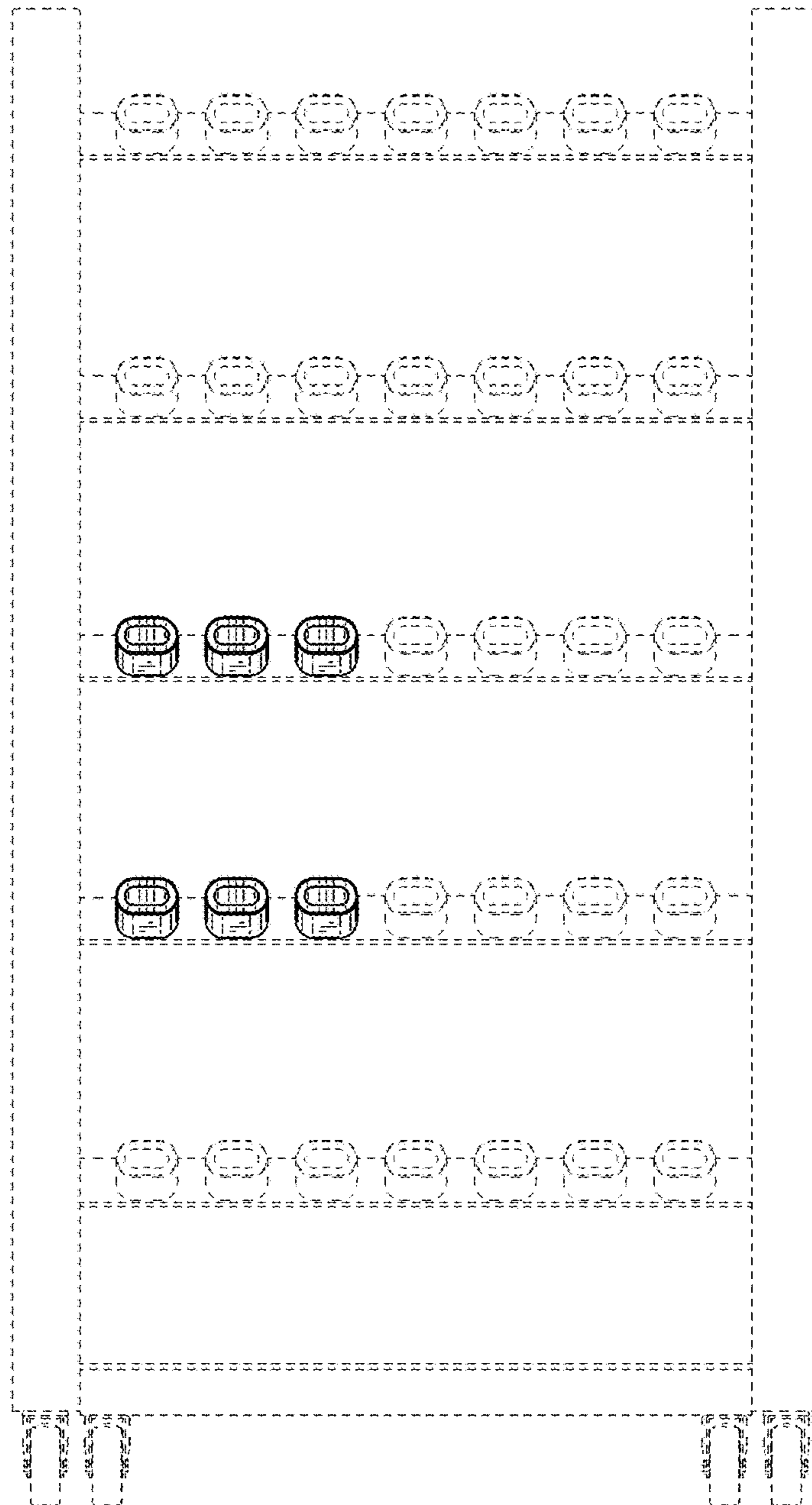

**FIG. 4**

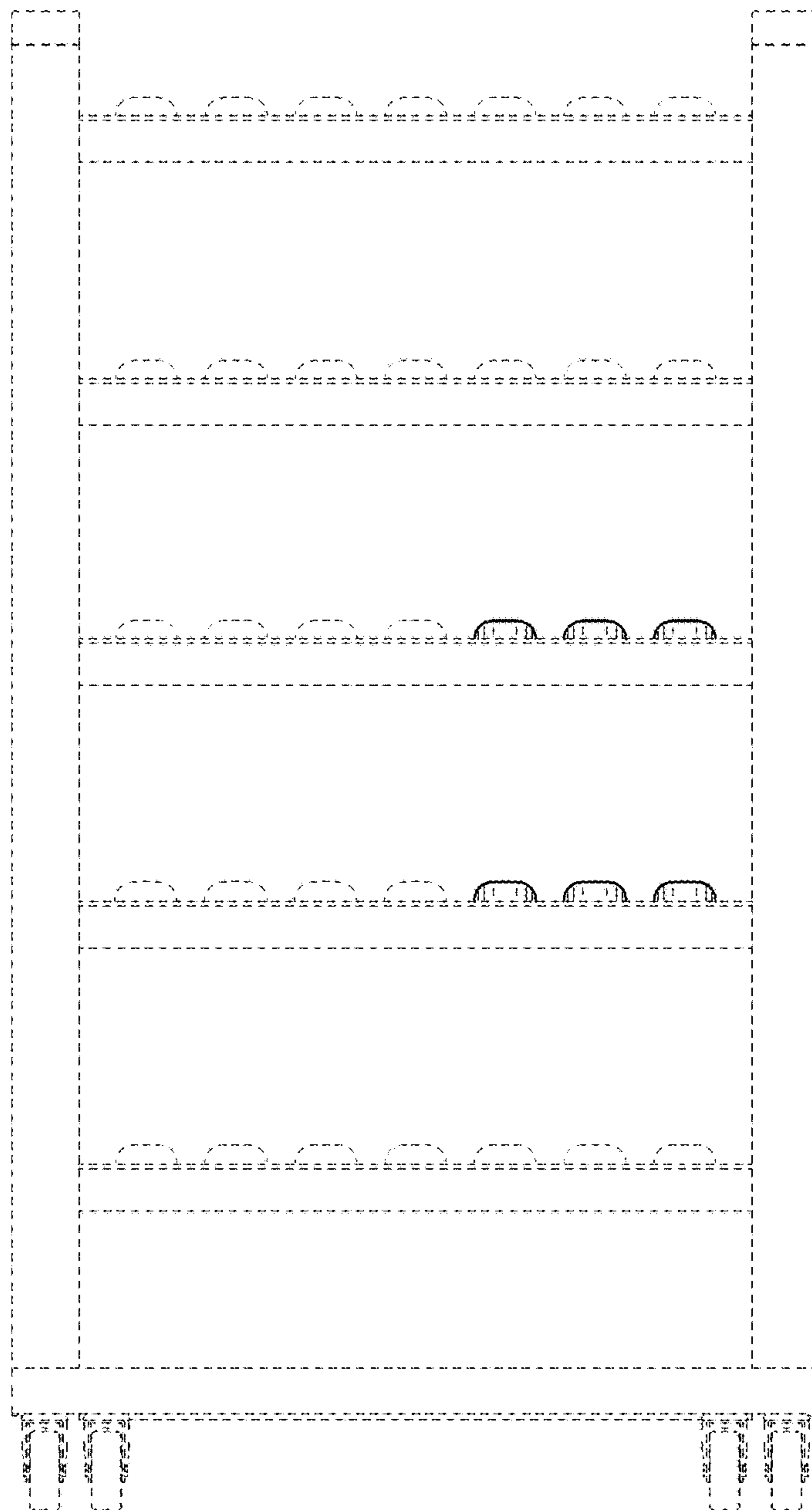

**FIG. 5**

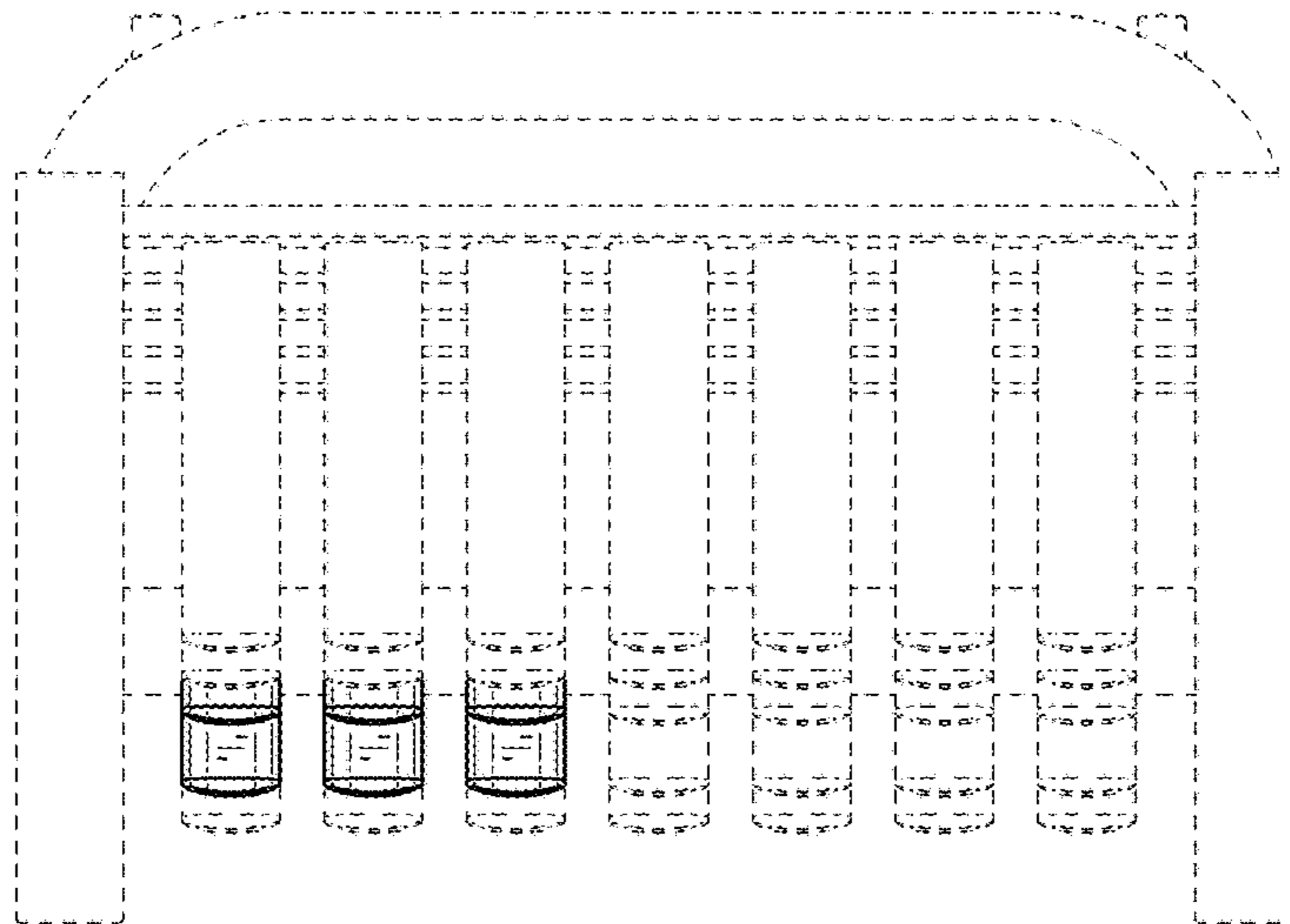

**FIG. 6**

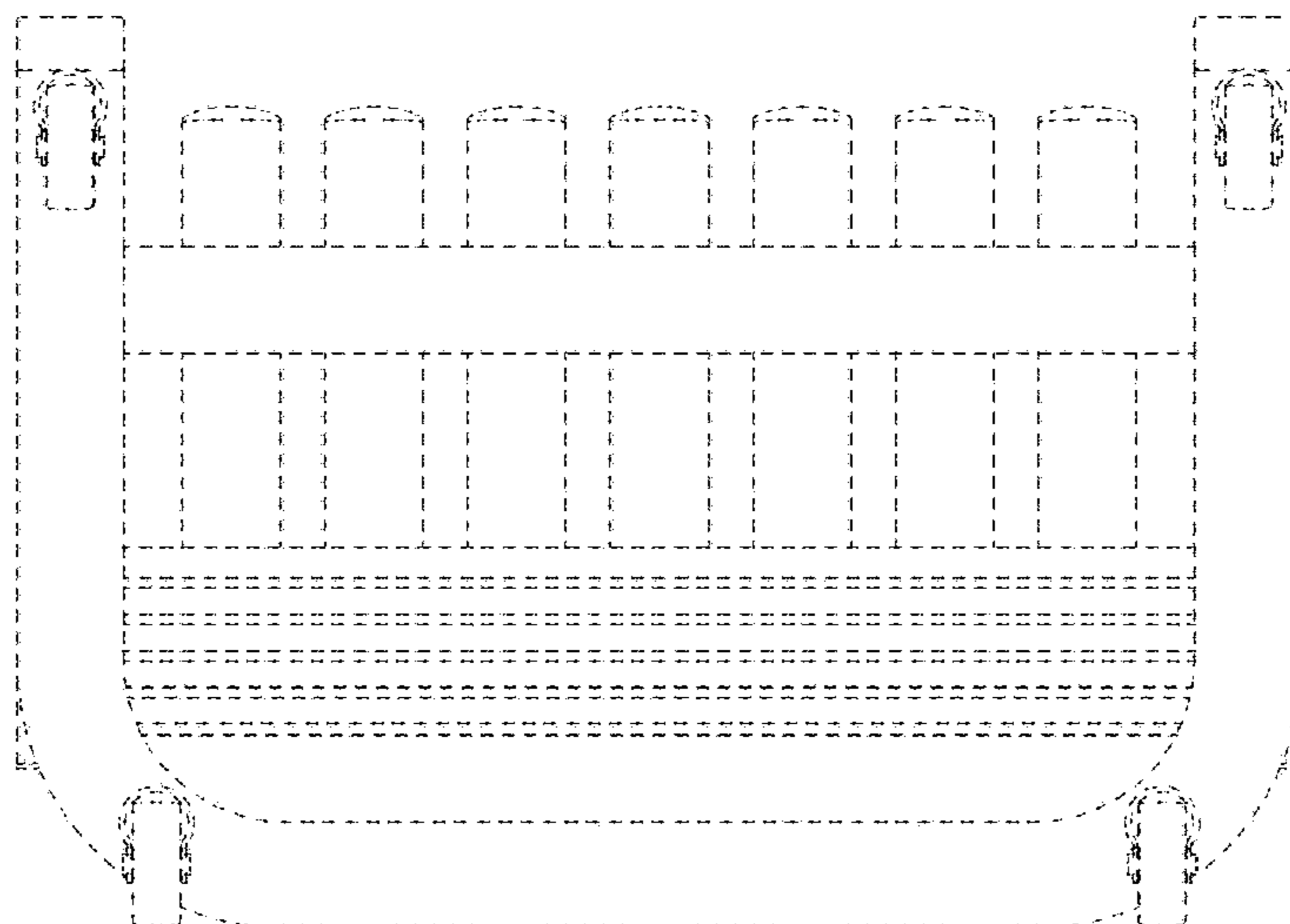

**FIG. 7**