



US00D861625S

(12) **United States Design Patent** (10) **Patent No.:** **US D861,625 S**
Ahn et al. (45) **Date of Patent:** **** Oct. 1, 2019**

(54) **DISPLAY DEVICE**

(71) Applicant: **SAMSUNG DISPLAY CO., LTD.**,
Yongin-si, Gyeonggi-do (KR)

(72) Inventors: **Sung Sang Ahn**, Hwaseong-si (KR);
Chang Min Park, Gwangmyeong-si (KR); **Sang Wol Lee**, Yongin-si (KR)

(73) Assignee: **Samsung Display Co., Ltd.**, Yongin-si (KR)

(**) Term: **15 Years**

(21) Appl. No.: **29/643,780**

(22) Filed: **Apr. 11, 2018**

(30) **Foreign Application Priority Data**

Oct. 12, 2017 (KR) 30-2017-0047463

(51) **LOC (12) Cl.** **14-03**

(52) **U.S. Cl.**
USPC **D14/126**

(58) **Field of Classification Search**
USPC D14/125-134, 239, 371, 136, 374-377,
D14/440, 450, 448, 336, 159, 341-345;
312/7.2; 348/836, 838, 180, 184, 325,
348/739; 248/917-924, 465; 345/104,
345/133, 156, 168, 87, 173; D21/329,
D21/515, 577, 622, 333, 433, 448, 452,
D21/450, 331, 505; D10/15, 26;
446/484, 175, 356; D6/477, 479, 300,
D6/308; D24/185; D34/14; 361/679.21;
D19/113, 114; D20/10
CPC ... G06F 1/1601; G06F 1/1643; H05K 5/0004;
H05K 5/0017; H05K 5/02; H05K 5/0217
See application file for complete search history.

(56) **References Cited**

U.S. PATENT DOCUMENTS

D584,726 S * 1/2009 Morita D14/341
D710,354 S * 8/2014 Ahn D14/345

D797,732 S * 9/2017 Chong D14/371
D807,842 S * 1/2018 Sugita D14/126
2012/0206896 A1* 8/2012 Suzuki G06F 1/1616
361/807

* cited by examiner

Primary Examiner — Randall H Gholson

(74) *Attorney, Agent, or Firm* — Lewis Roca Rothgerber
Christie LLP

(57) **CLAIM**

The ornamental design for a display device, as shown and described.

DESCRIPTION

FIG. 1 is a perspective view of the display device in an unfolded state;
FIG. 2 is a front view thereof;
FIG. 3 is a rear view thereof;
FIG. 4 is a left side view thereof;
FIG. 5 is a right side view thereof;
FIG. 6 is a top view thereof, with the bottom view being a mirror image;
FIG. 7 is a perspective view of the display device in a folded state;
FIG. 8 is a front view thereof;
FIG. 9 is a rear view thereof;
FIG. 10 is a left side view thereof;
FIG. 11 is a right side view thereof;
FIG. 12 is a top view thereof, with the bottom view being a mirror image; and,
FIGS. 13 to 15 illustrate that images can be displayed on the screen of the display device, but the images are shown for reference only and form no part of the design.
The broken lines shown in the drawings are for illustrative purposes only and form no part of the claimed design.

1 Claim, 13 Drawing Sheets

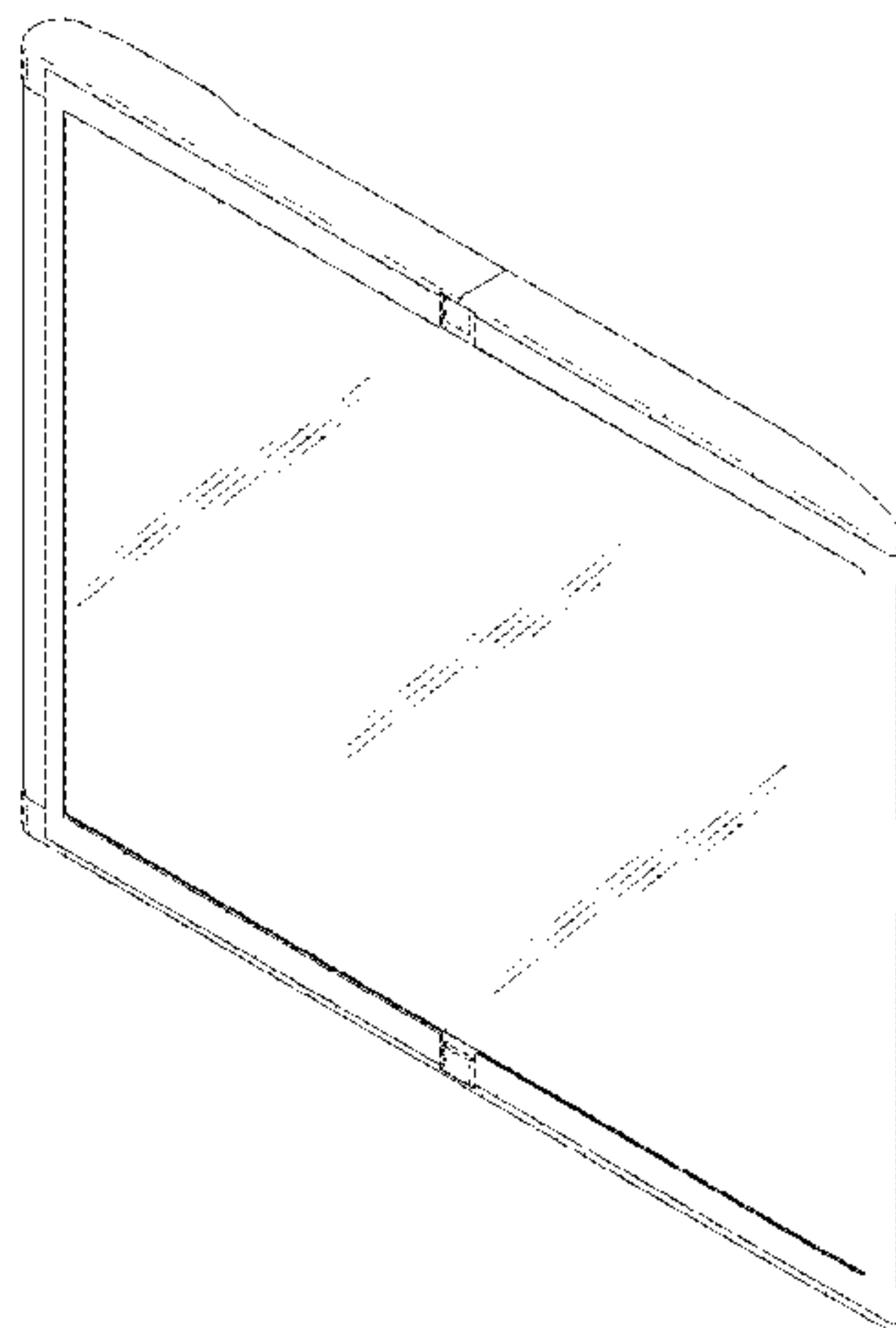

FIG. 1

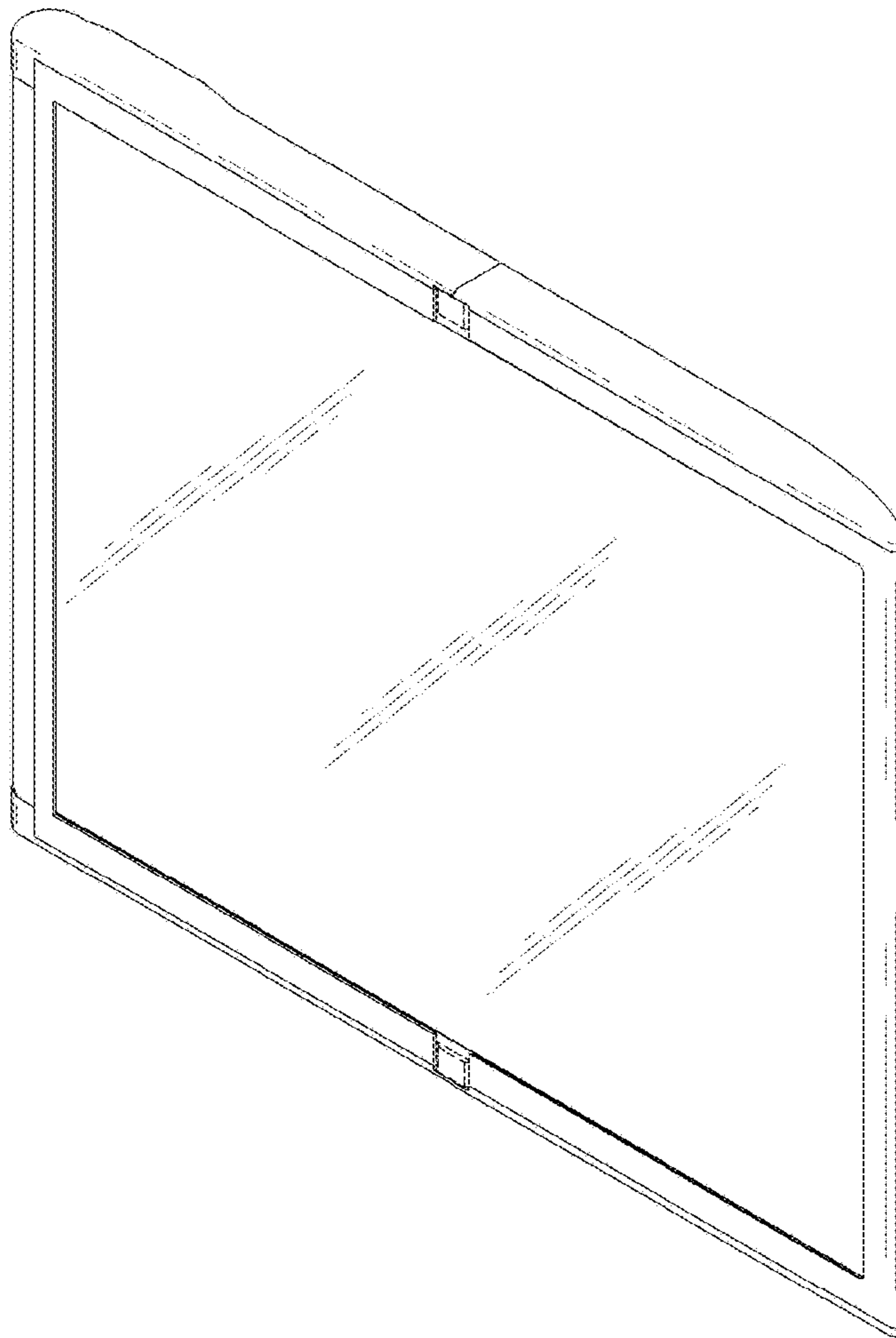

FIG. 2

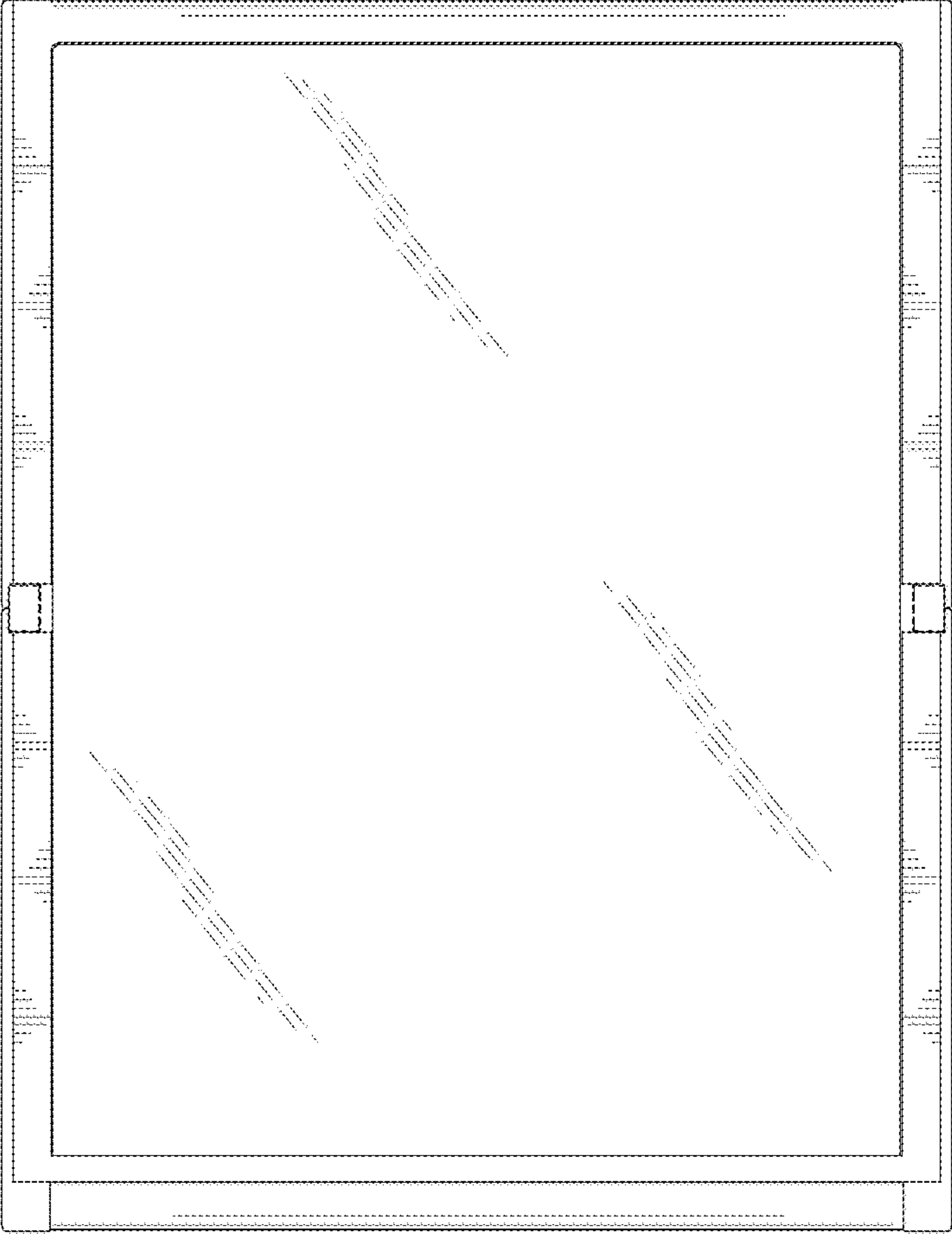

FIG. 3

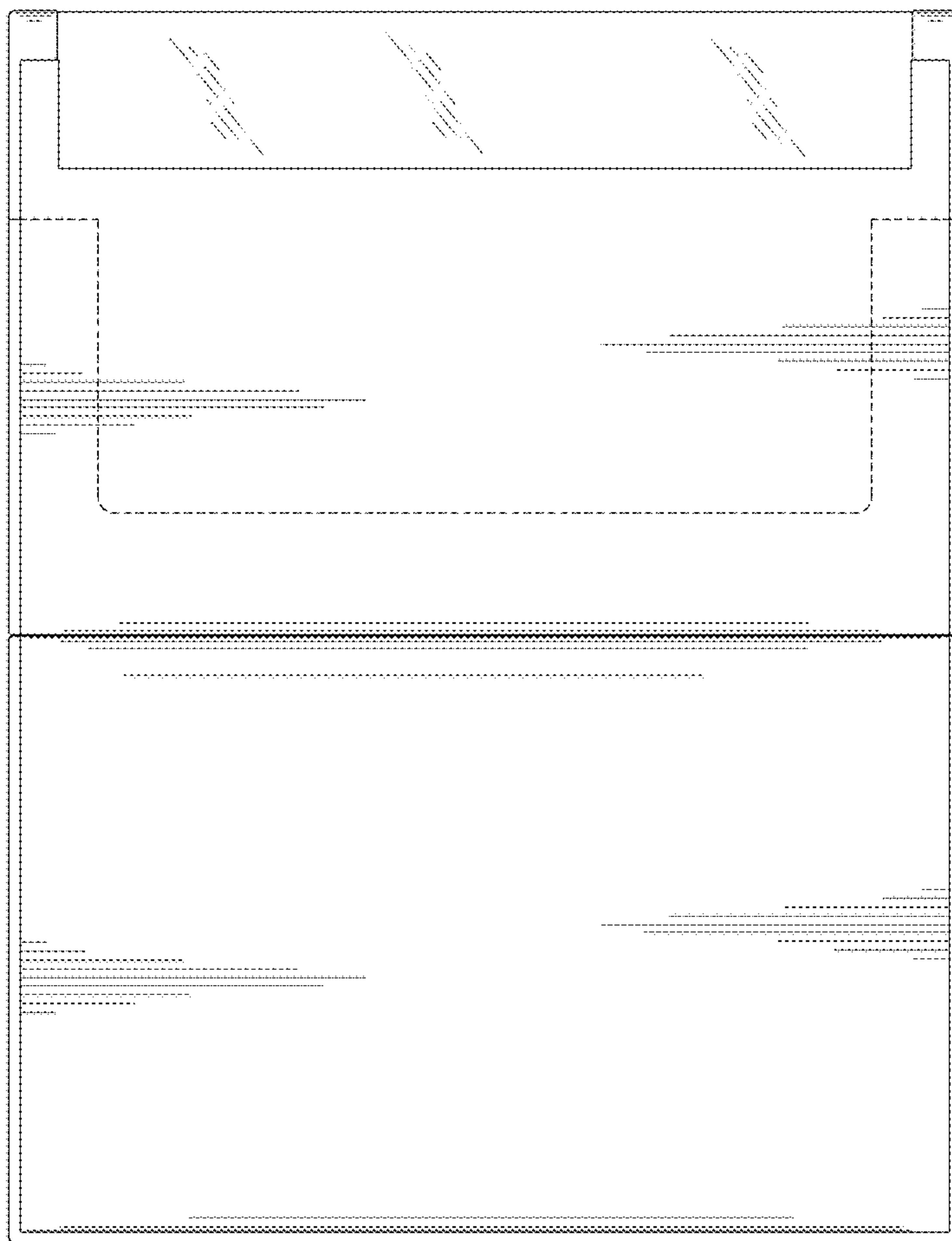

FIG. 4



FIG. 5

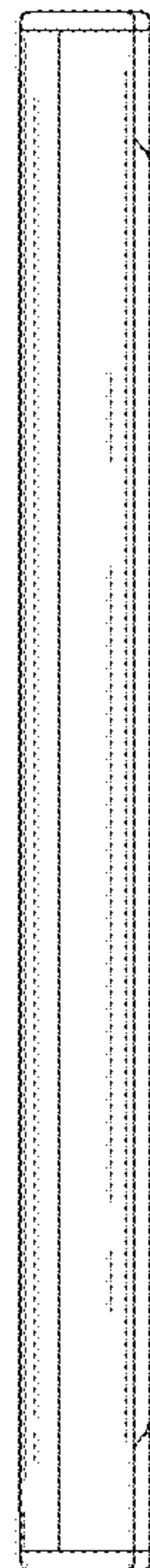

FIG. 6

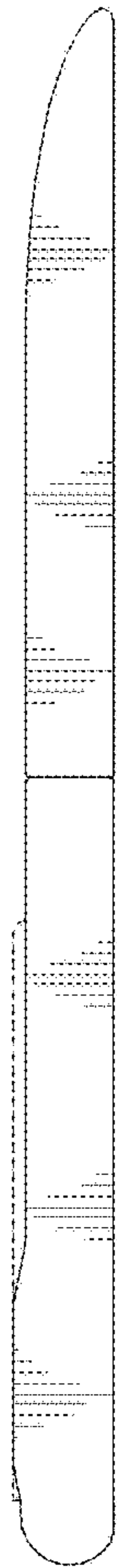

FIG. 7

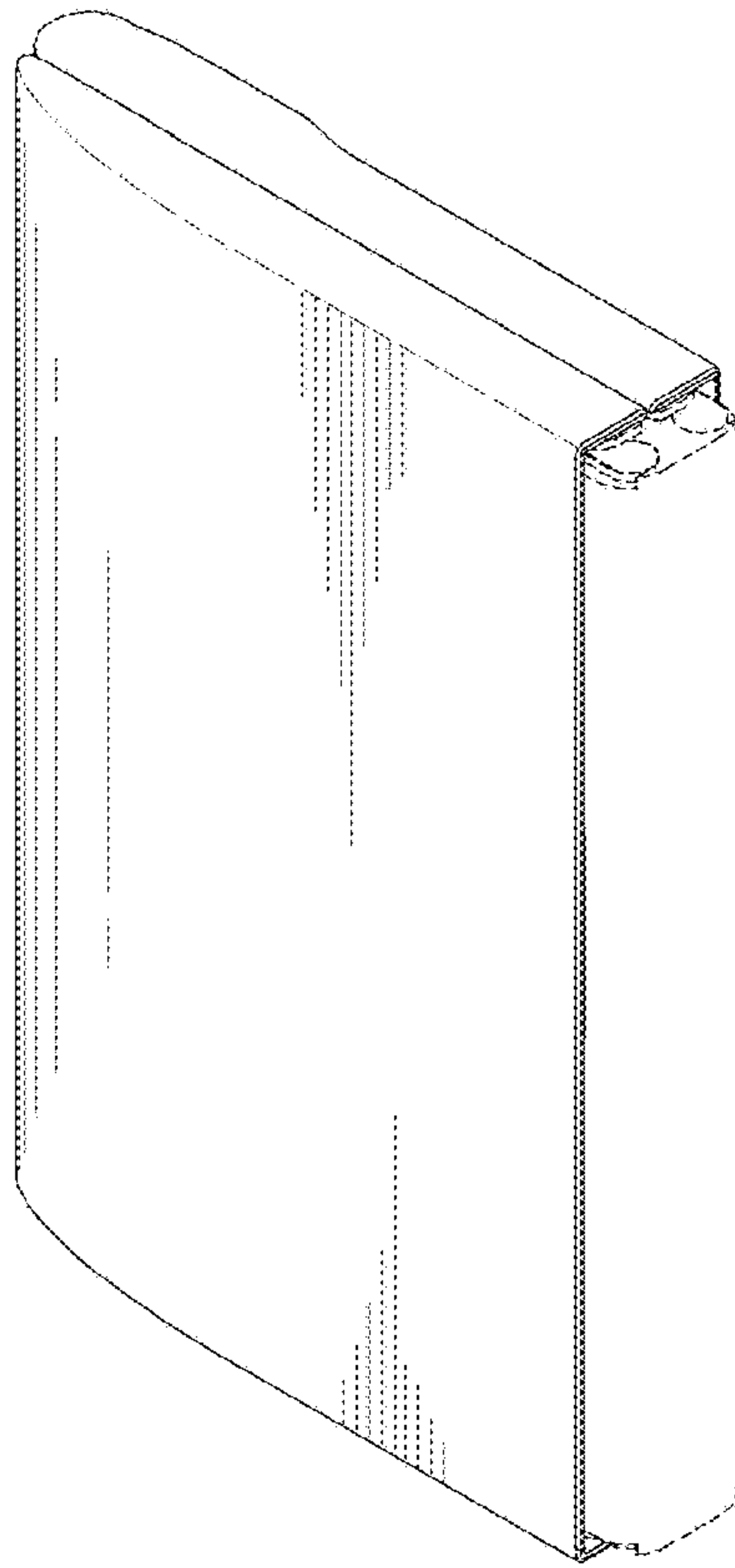

FIG. 8

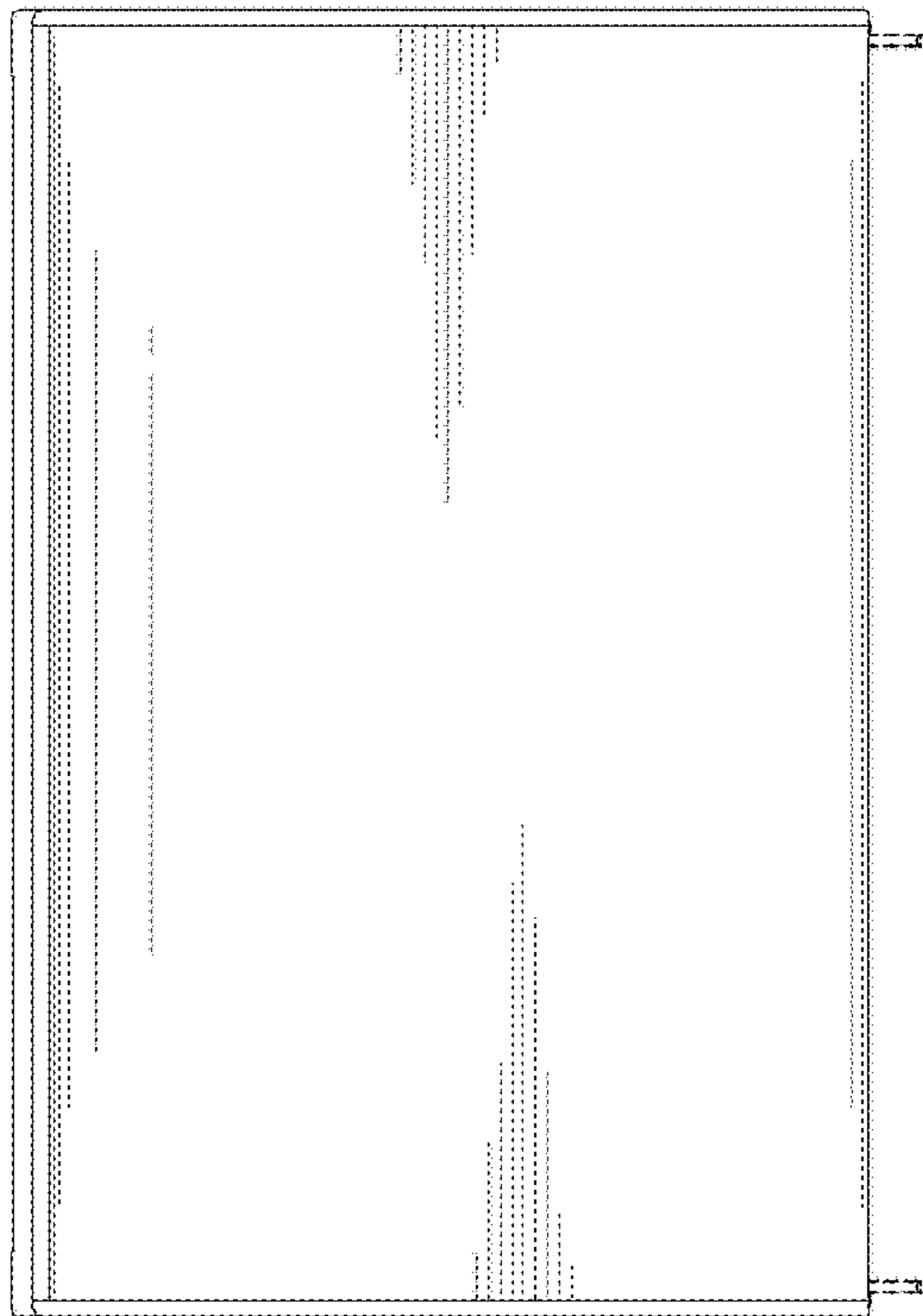

FIG. 9

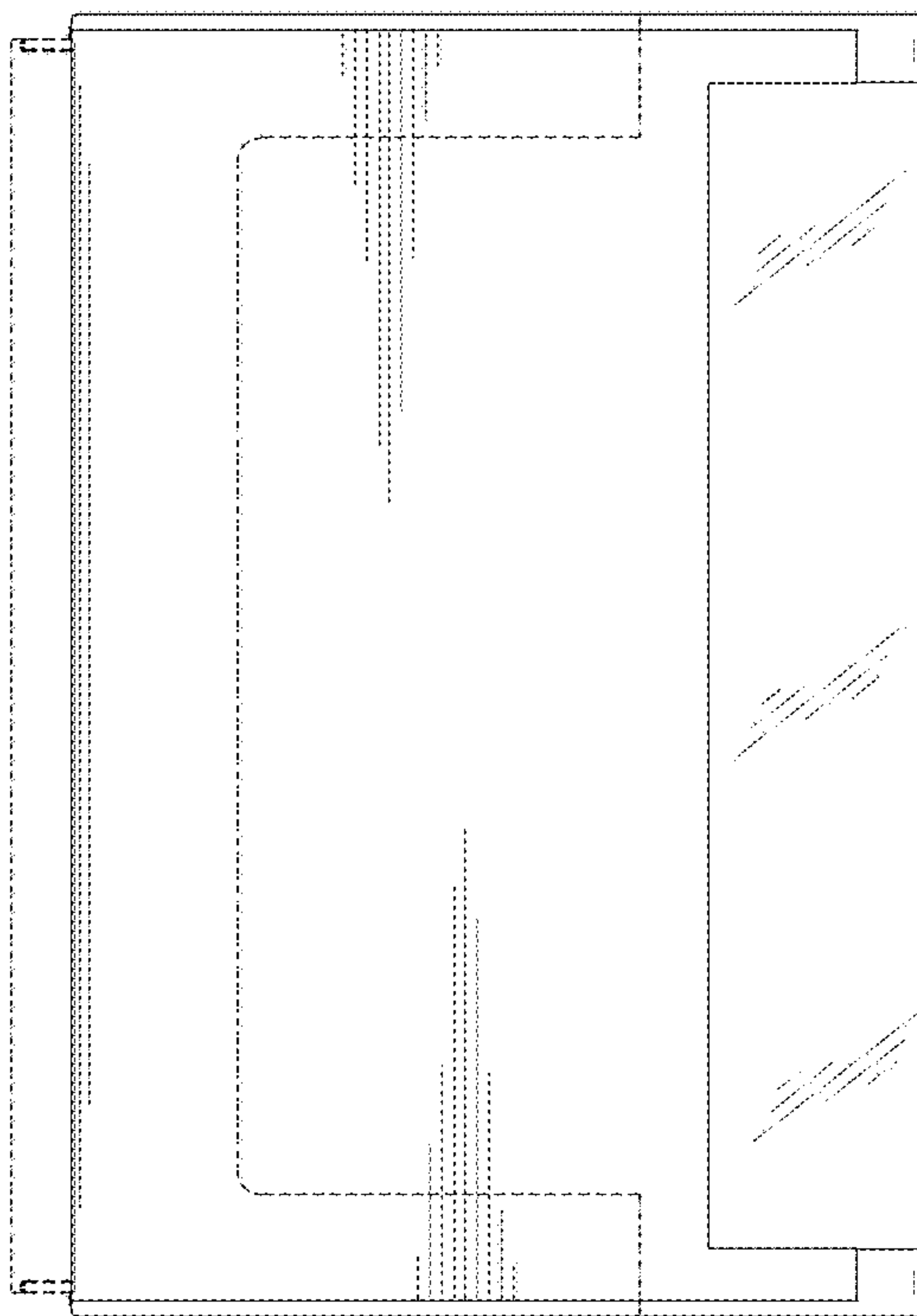

FIG. 10

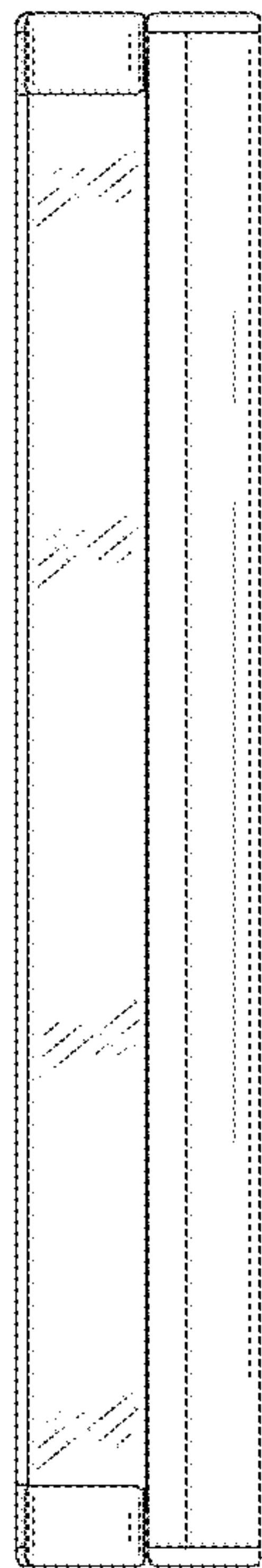

FIG. 11

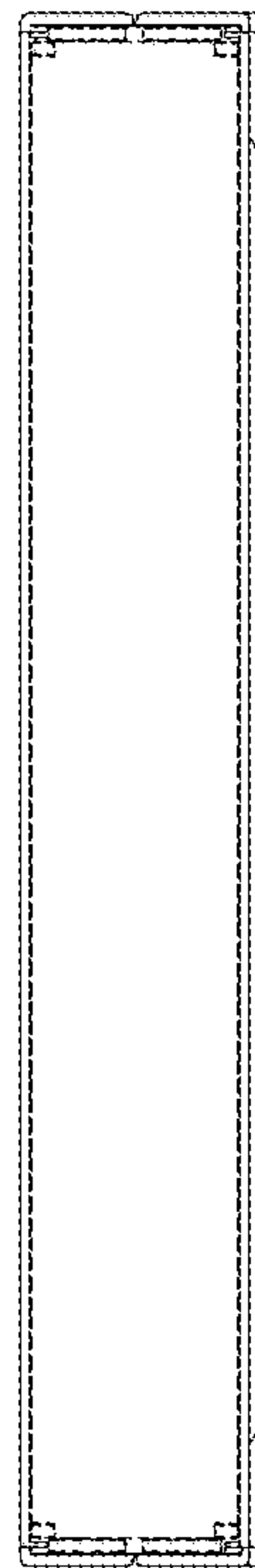

FIG. 12

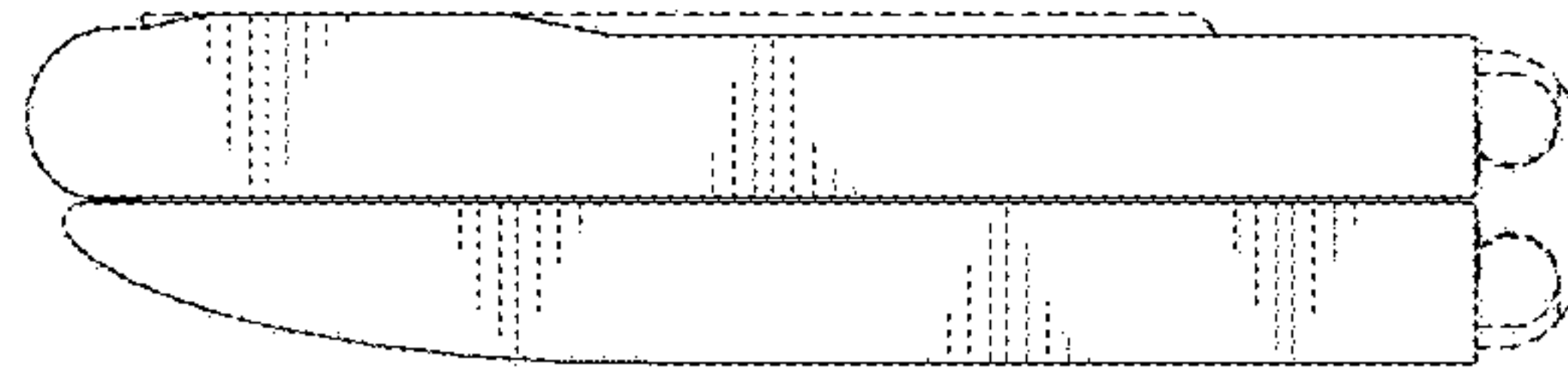

FIG. 13

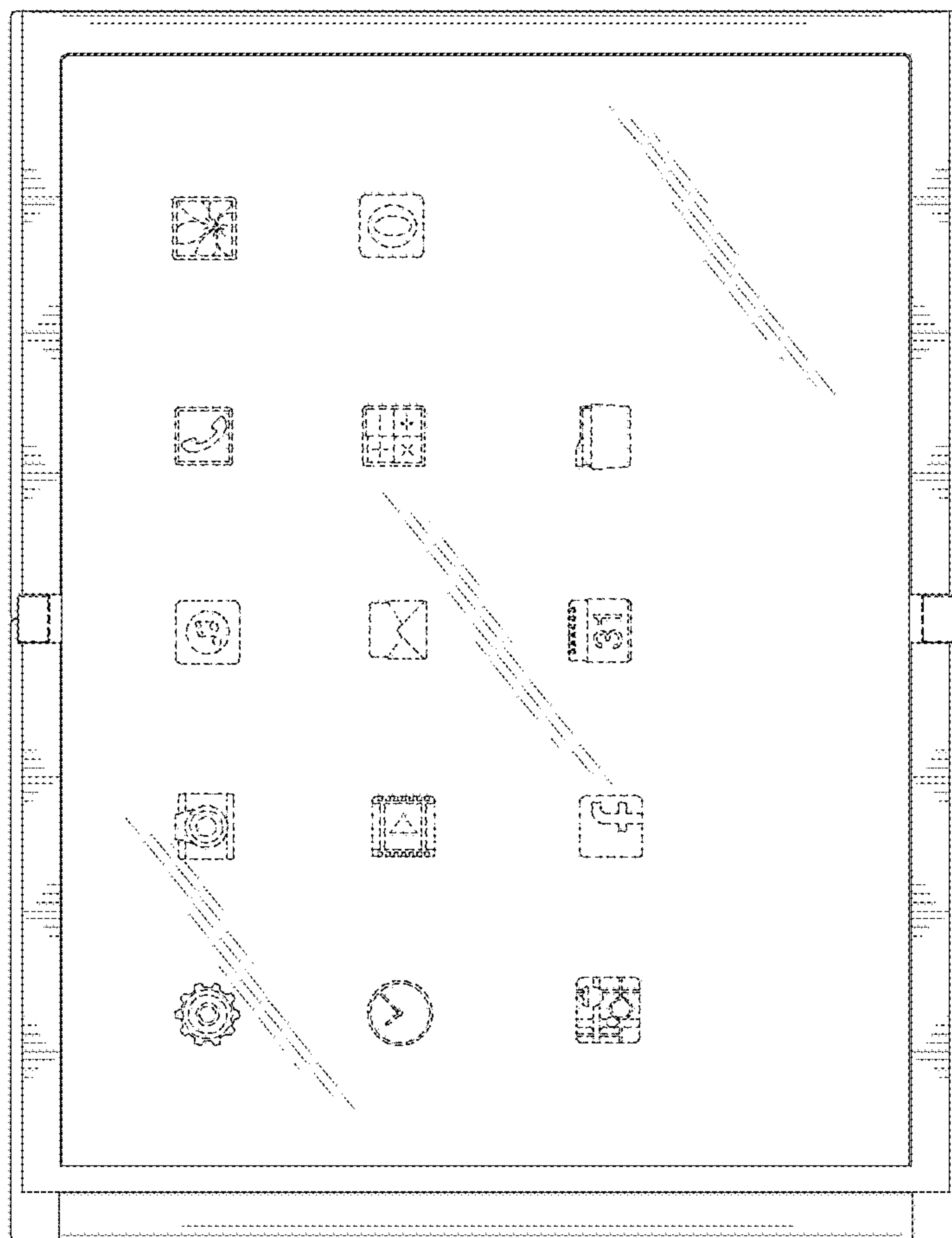

FIG. 14

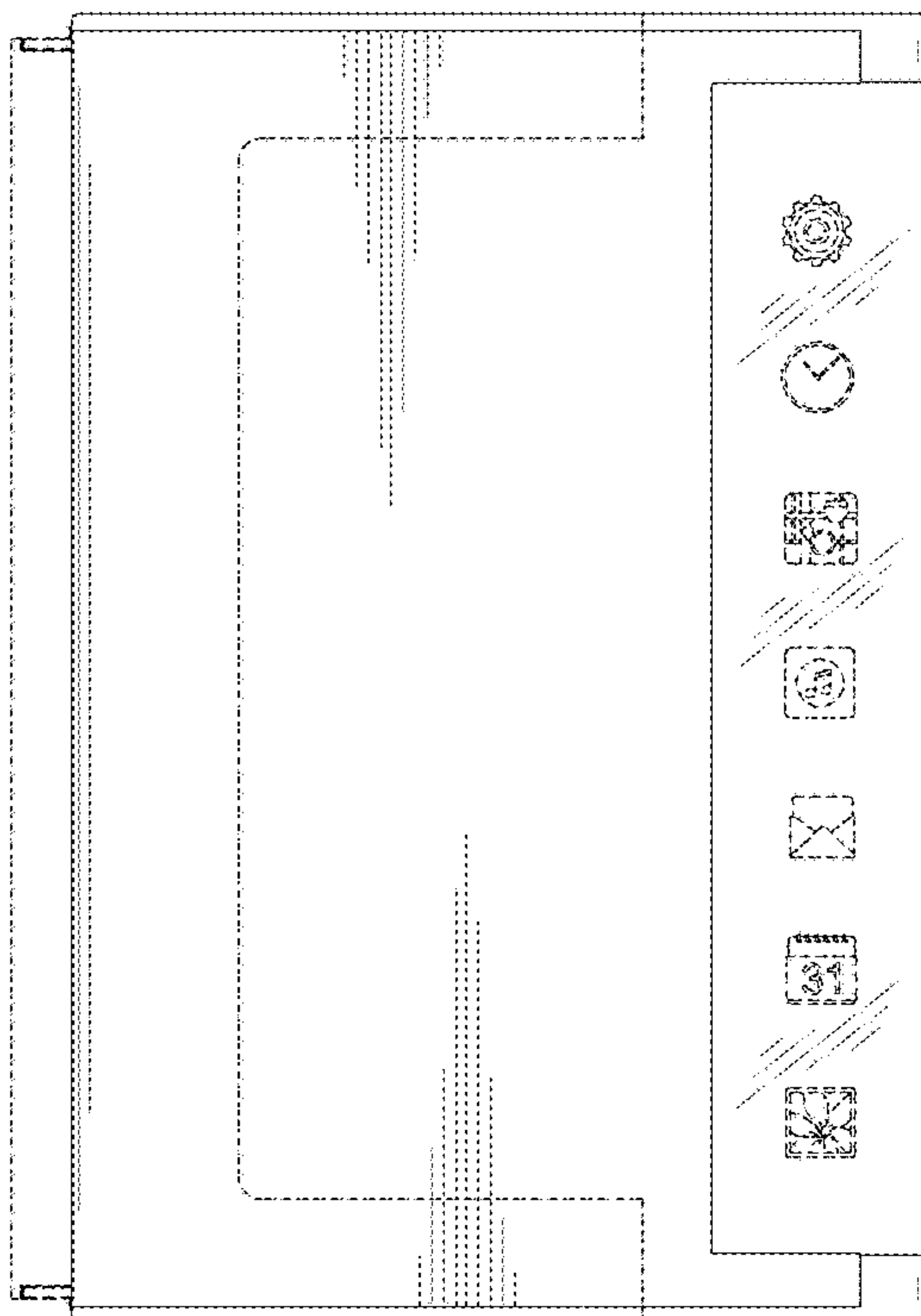

FIG. 15

