



US00D861624S

(12) **United States Design Patent** (10) **Patent No.:** **US D861,624 S**
Ahn et al. (45) **Date of Patent:** **** Oct. 1, 2019**

(54) **DISPLAY DEVICE**

(71) Applicant: **SAMSUNG DISPLAY CO., LTD.**,
Yongin-si, Gyeonggi-do (KR)

(72) Inventors: **Hung Kun Ahn**, Seongnam-si (KR);
Sang Wol Lee, Yongin-si (KR); **Sung Guk An**, Suwon-si (KR); **Sang Gu Kim**, Seoul (KR); **Jae Hoon Jung**,
Bucheon-si (KR)

(73) Assignee: **Samsung Display Co., Ltd.**, Yongin-si
(KR)

(**) Term: **15 Years**

(21) Appl. No.: **29/643,769**

(22) Filed: **Apr. 11, 2018**

(30) **Foreign Application Priority Data**

Oct. 12, 2017 (KR) 30-2017-0047462

(51) **LOC (12) Cl.** **14-03**

(52) **U.S. Cl.**
USPC **D14/126**

(58) **Field of Classification Search**

USPC D14/125-134, 239, 371, 136, 374-377,
D14/440, 450, 448, 336, 342, 159;
312/7.2; 348/836, 838, 180, 184, 325,
348/739; 248/917-924, 465; 345/104,
345/133, 156, 168, 87, 173; D21/329,
D21/515, 577, 622, 333, 433, 448, 452,
D21/450, 331, 505; D10/15, 26;
446/484, 175, 356; D6/477, 479, 300;
D24/185; D34/14; 361/679.21

CPC ... G06F 1/1601; G06F 1/1643; H05K 5/0004;
H05K 5/0017; H05K 5/02; H05K 5/0217

See application file for complete search history.

(56) **References Cited**

U.S. PATENT DOCUMENTS

D584,726 S * 1/2009 Morita D14/341
D710,354 S * 8/2014 Ahn D14/345
D797,732 S * 9/2017 Chong D14/371

(Continued)

Primary Examiner — Randall H Gholson

(74) *Attorney, Agent, or Firm* — Lewis Roca Rothgerber
Christie LLP

(57) **CLAIM**

The ornamental design for a display device, as shown and
described.

DESCRIPTION

FIG. 1 is a perspective view of the display device in a folded
state;

FIG. 2 is a front view thereof;

FIG. 3 is a rear view thereof;

FIG. 4 is a left side view thereof;

FIG. 5 is a right side view thereof;

FIG. 6 is a top view thereof, with the bottom view being a
mirror image;

FIG. 7 is an another perspective view thereof;

FIG. 8 is a perspective of the display device in an unfolded
state;

FIG. 9 is a front view thereof;

FIG. 10 is a rear view thereof;

FIG. 11 is a left side view thereof;

FIG. 12 is a right side view thereof;

FIG. 13 is a top view thereof, with the bottom view being a
mirror image;

FIG. 14 is another perspective view thereof;

FIGS. 15 to 16 illustrate that images can be displayed on the
screen of the display device, but the images are shown for
reference only and form no part of the design; and,

(Continued)

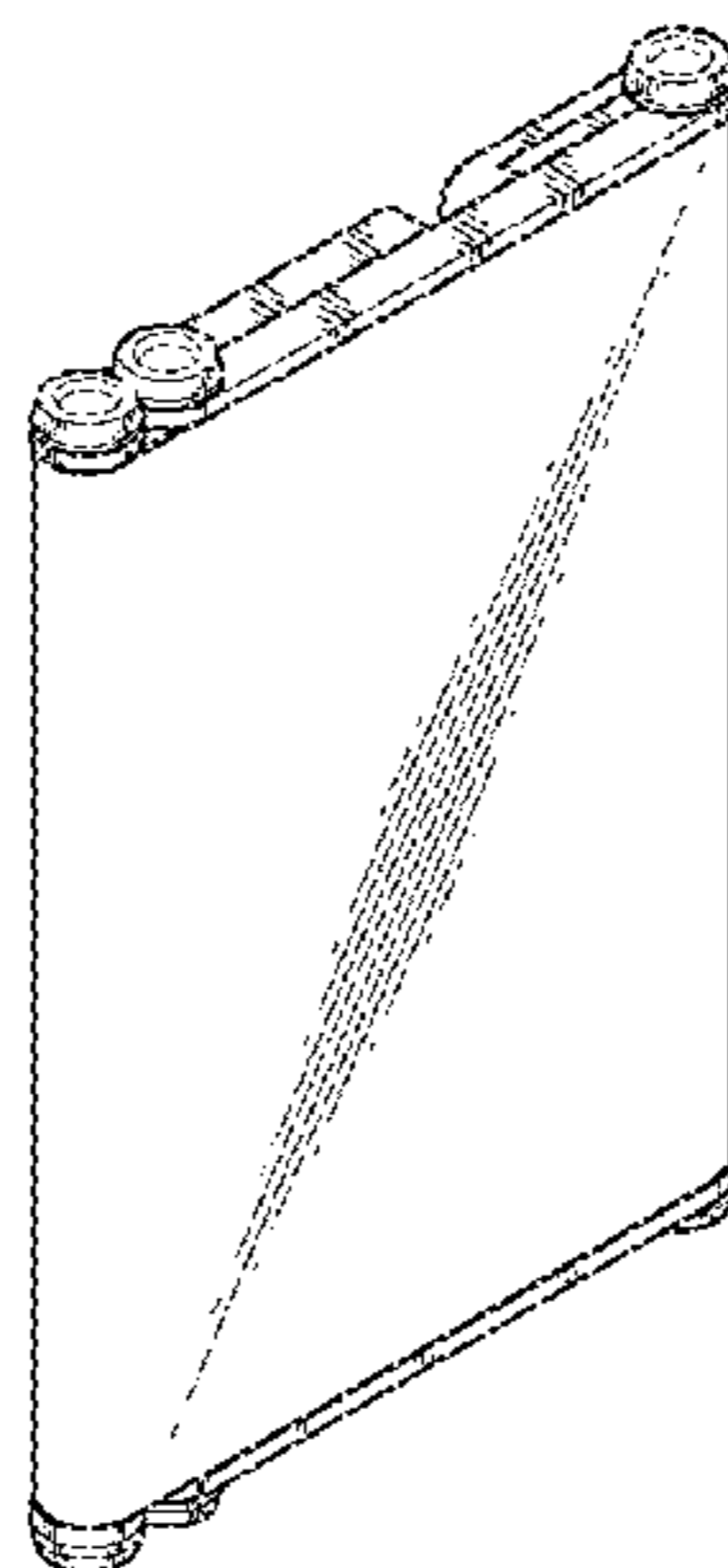

FIGS. 17 and 18 represent the display device when the display device is in a partially unfolded state. The broken lines shown in the drawings are for illustrative purposes only and form no part of the claimed design.

1 Claim, 18 Drawing Sheets

(56)

References Cited

U.S. PATENT DOCUMENTS

D807,842 S *	1/2018	Sugita	D14/126
2012/0206896 A1 *	8/2012	Suzuki	G06F 1/1616 361/807

* cited by examiner

FIG. 1

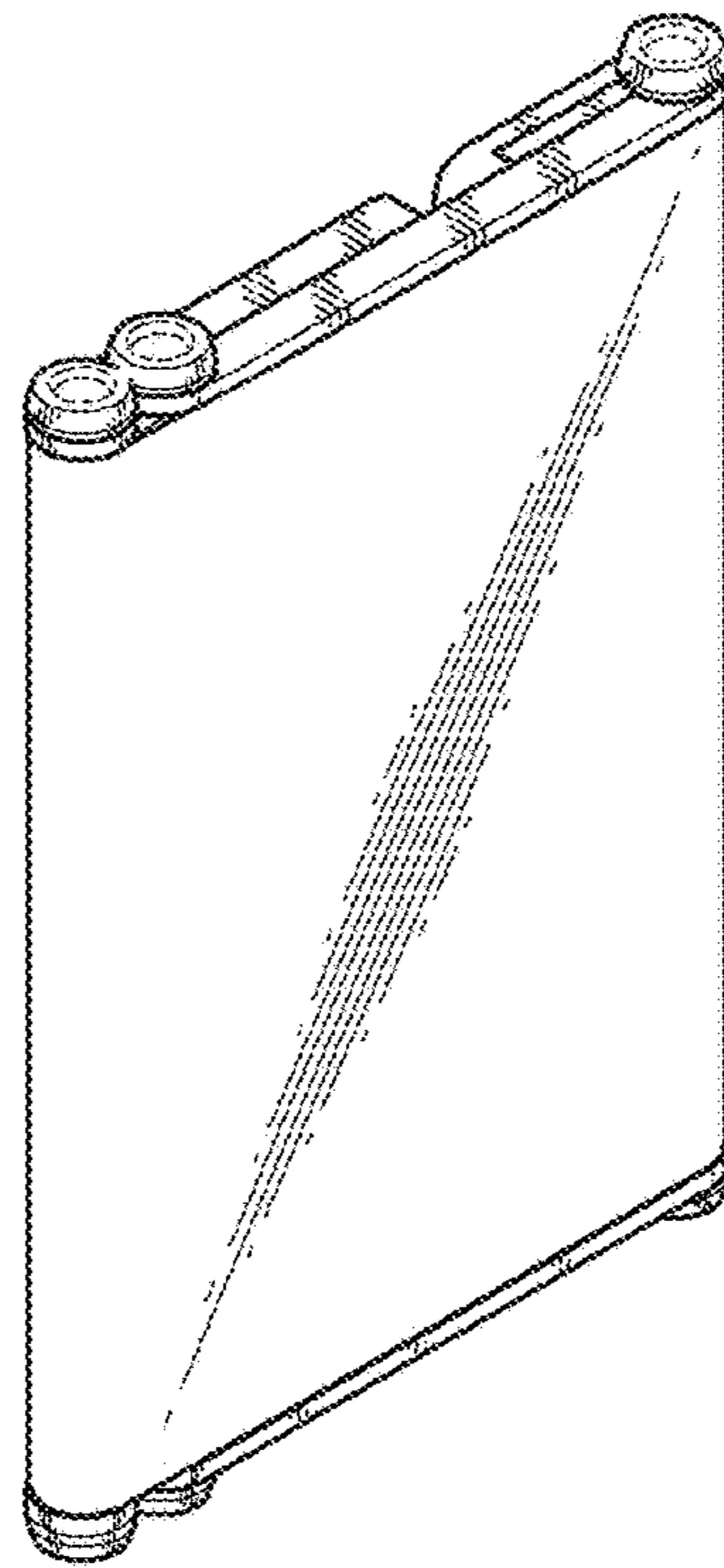

FIG. 2

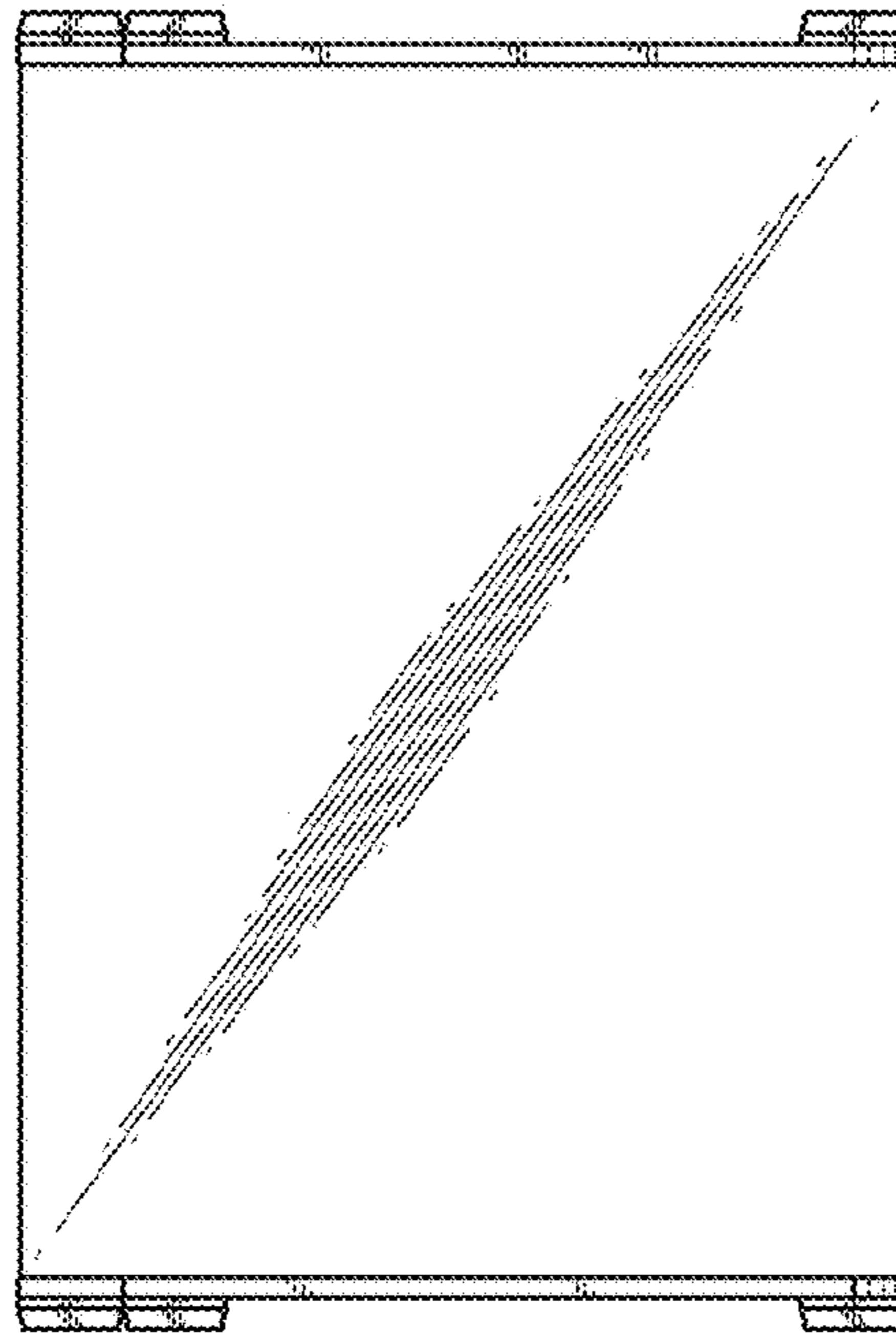

FIG. 3

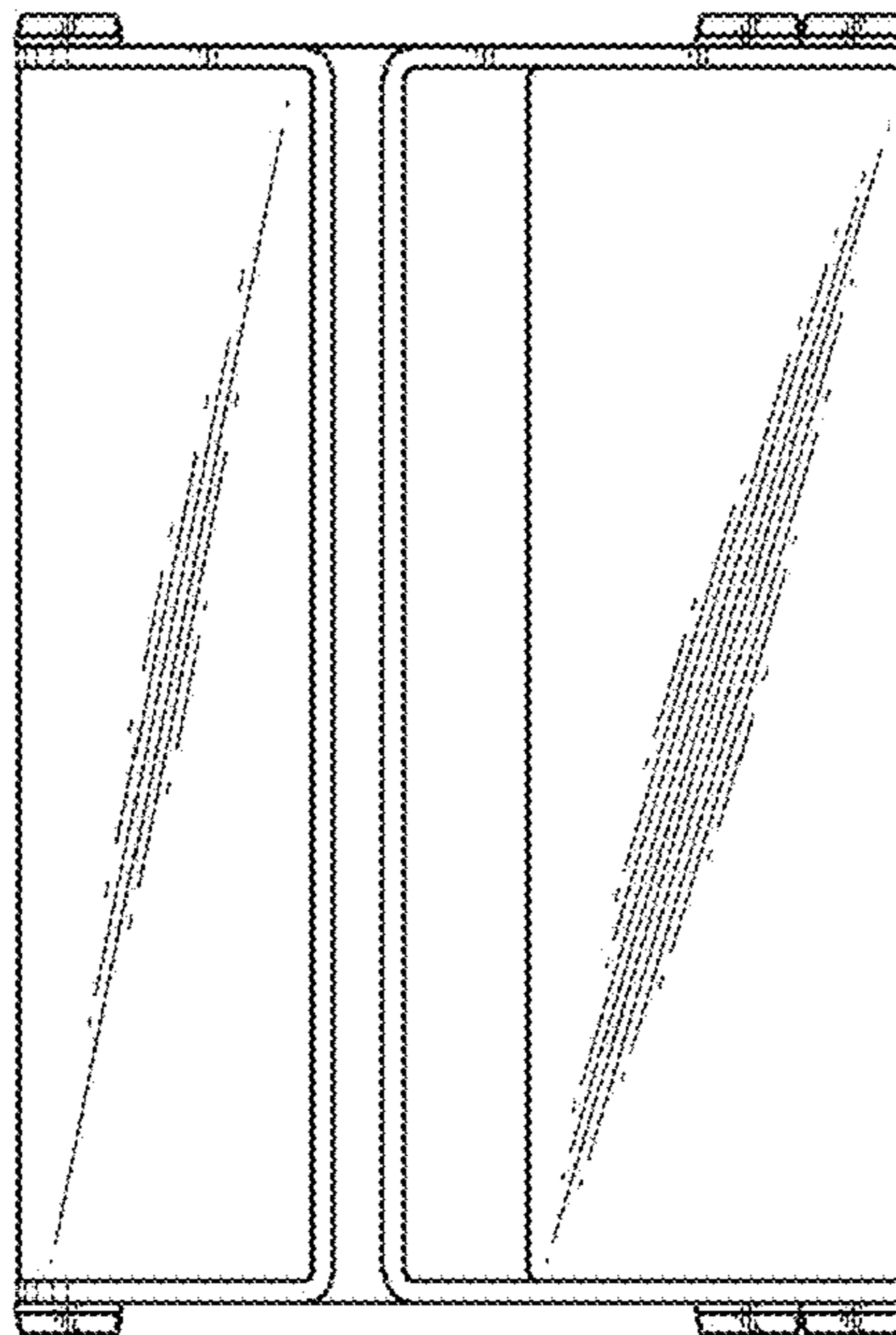

FIG. 4

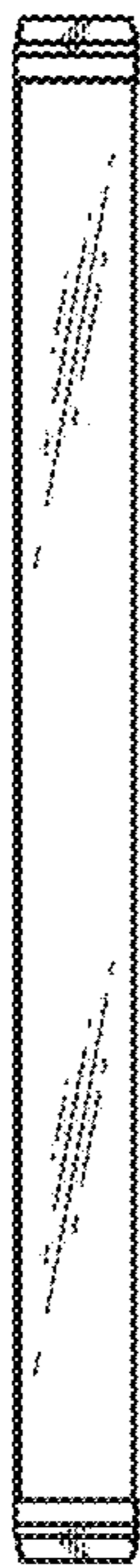

FIG. 5



FIG. 6



FIG. 7

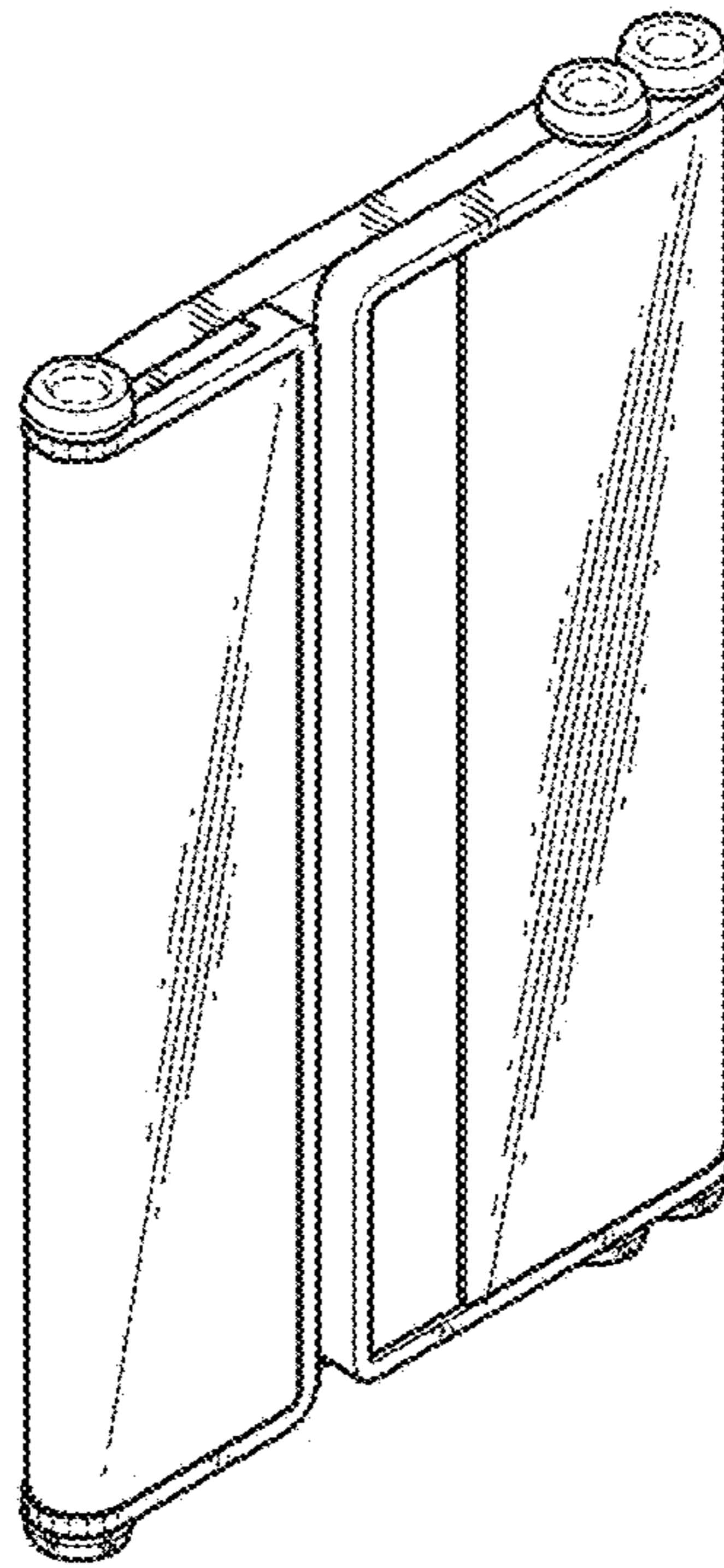

FIG. 8

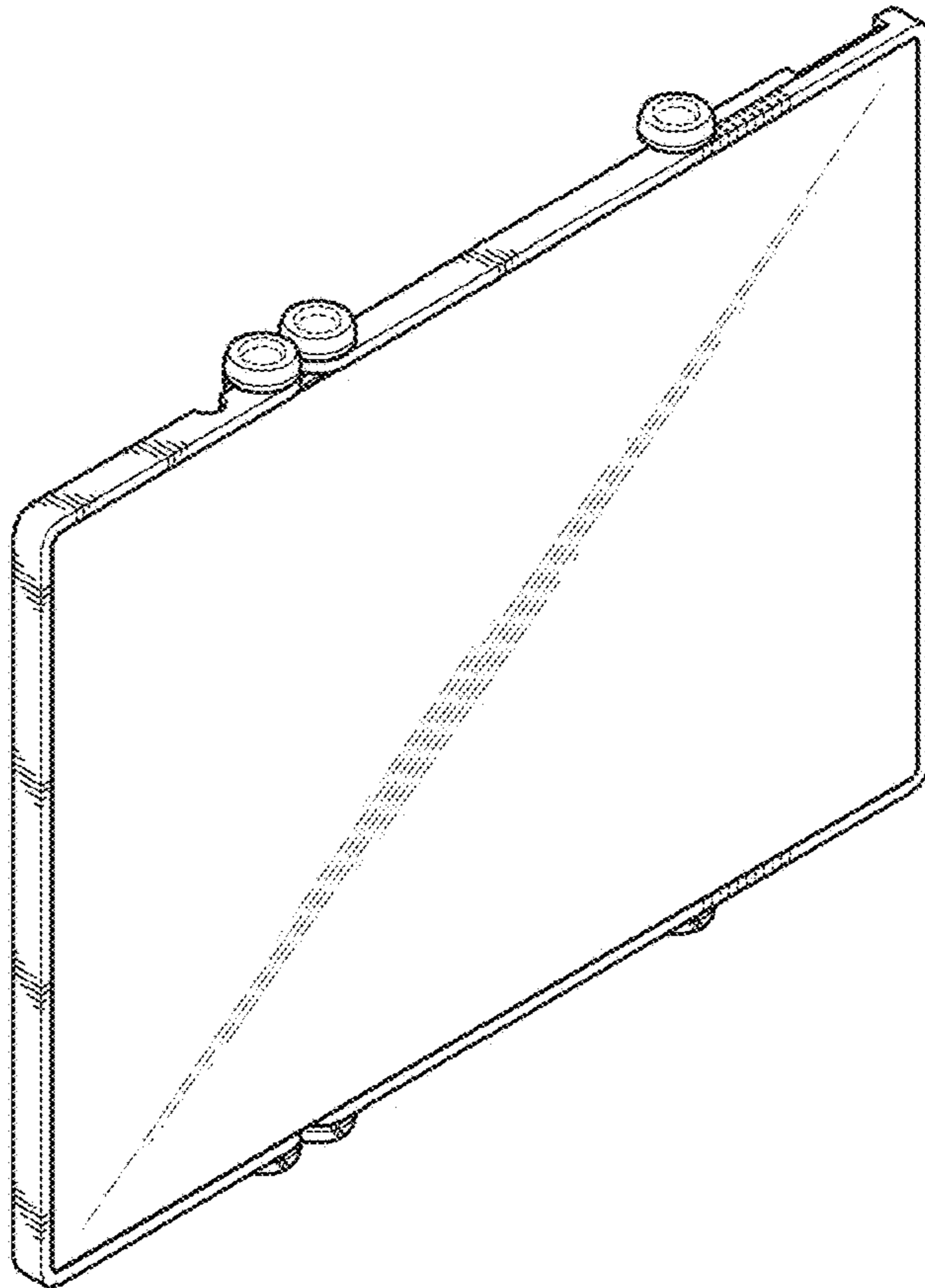

FIG. 9

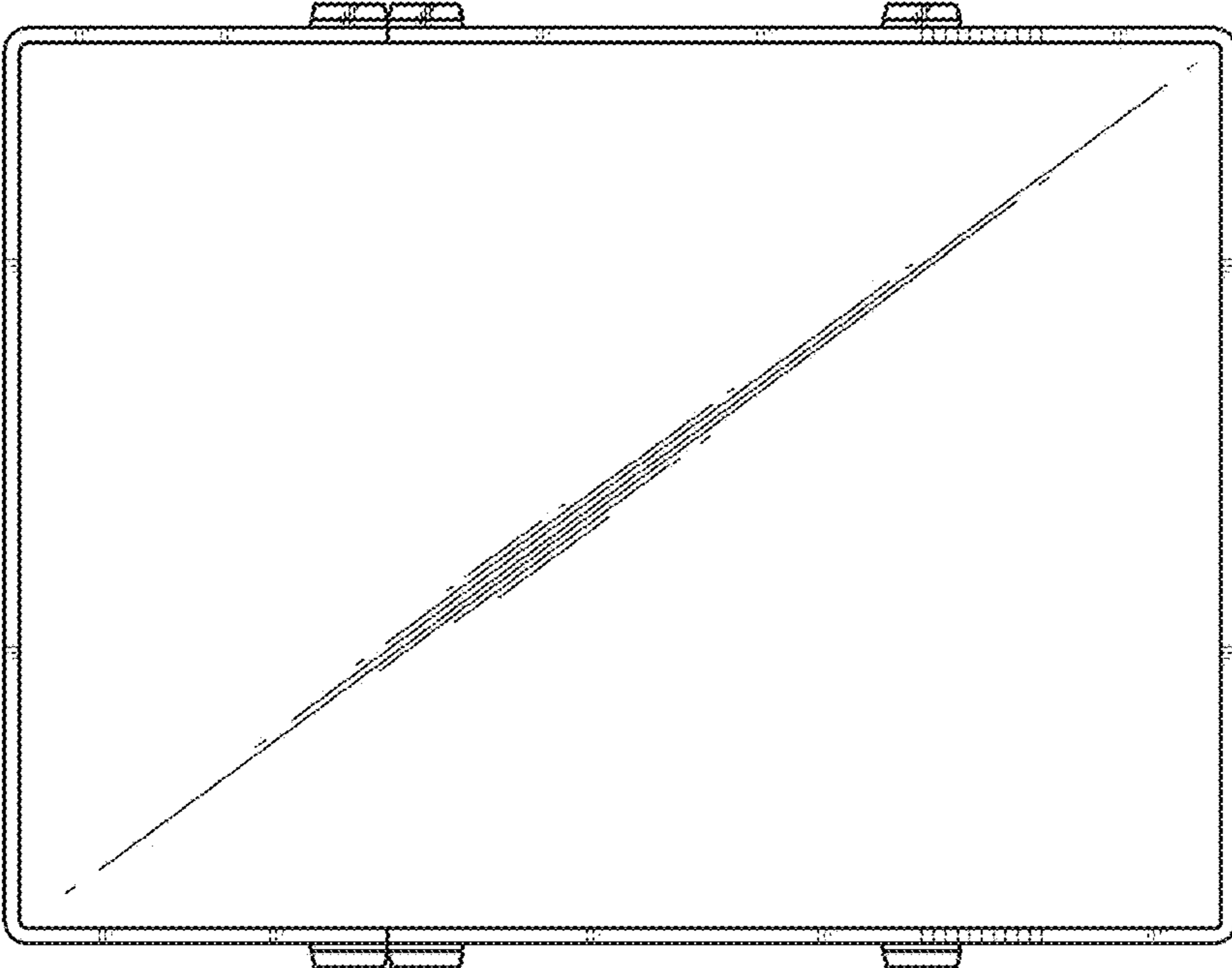

FIG. 10

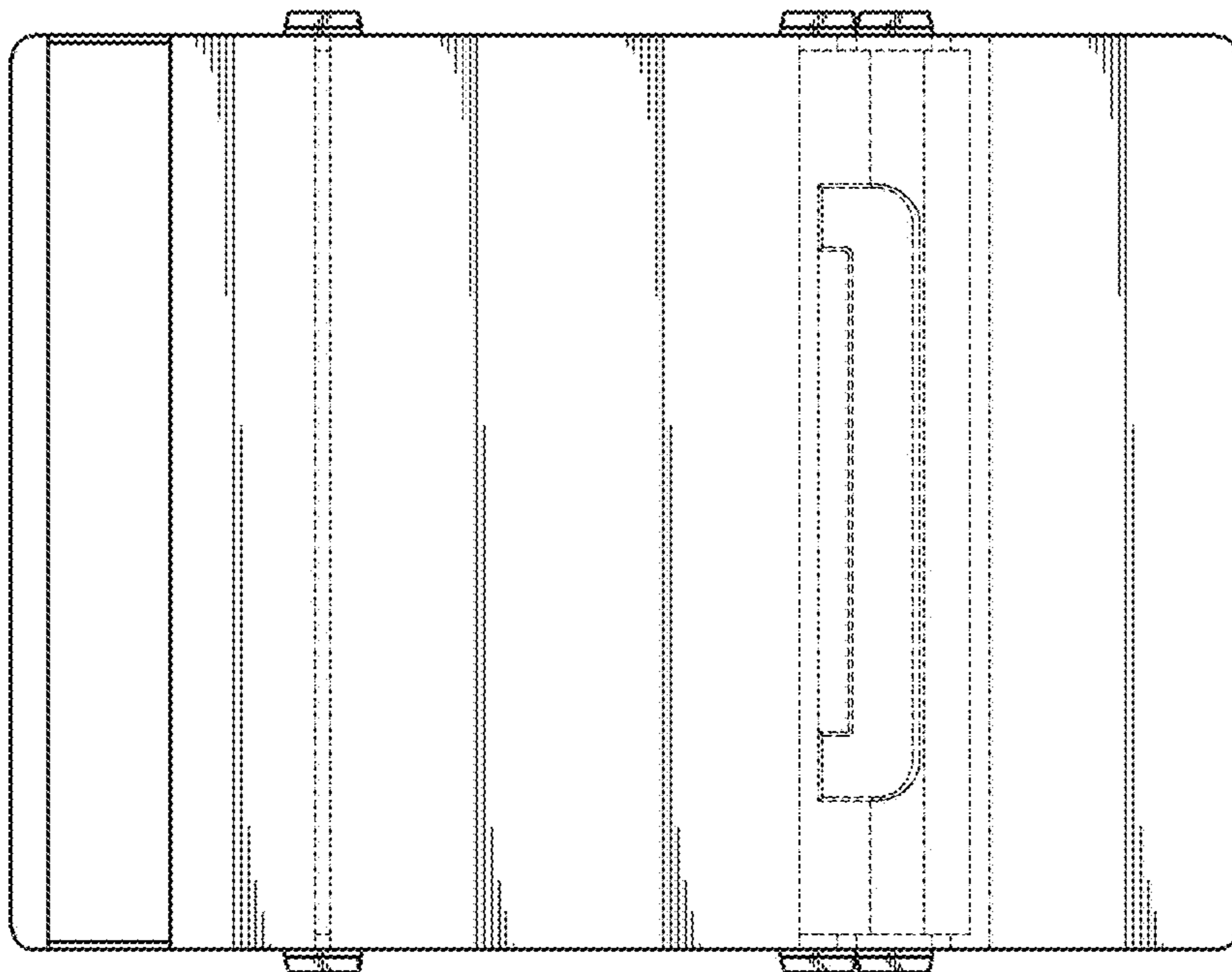

FIG. 11



FIG. 12

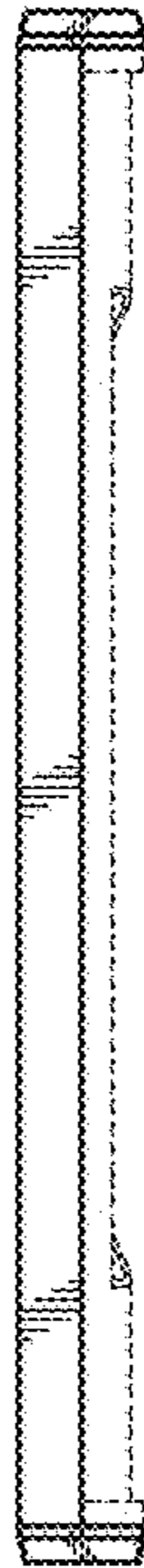

FIG. 13



FIG. 14

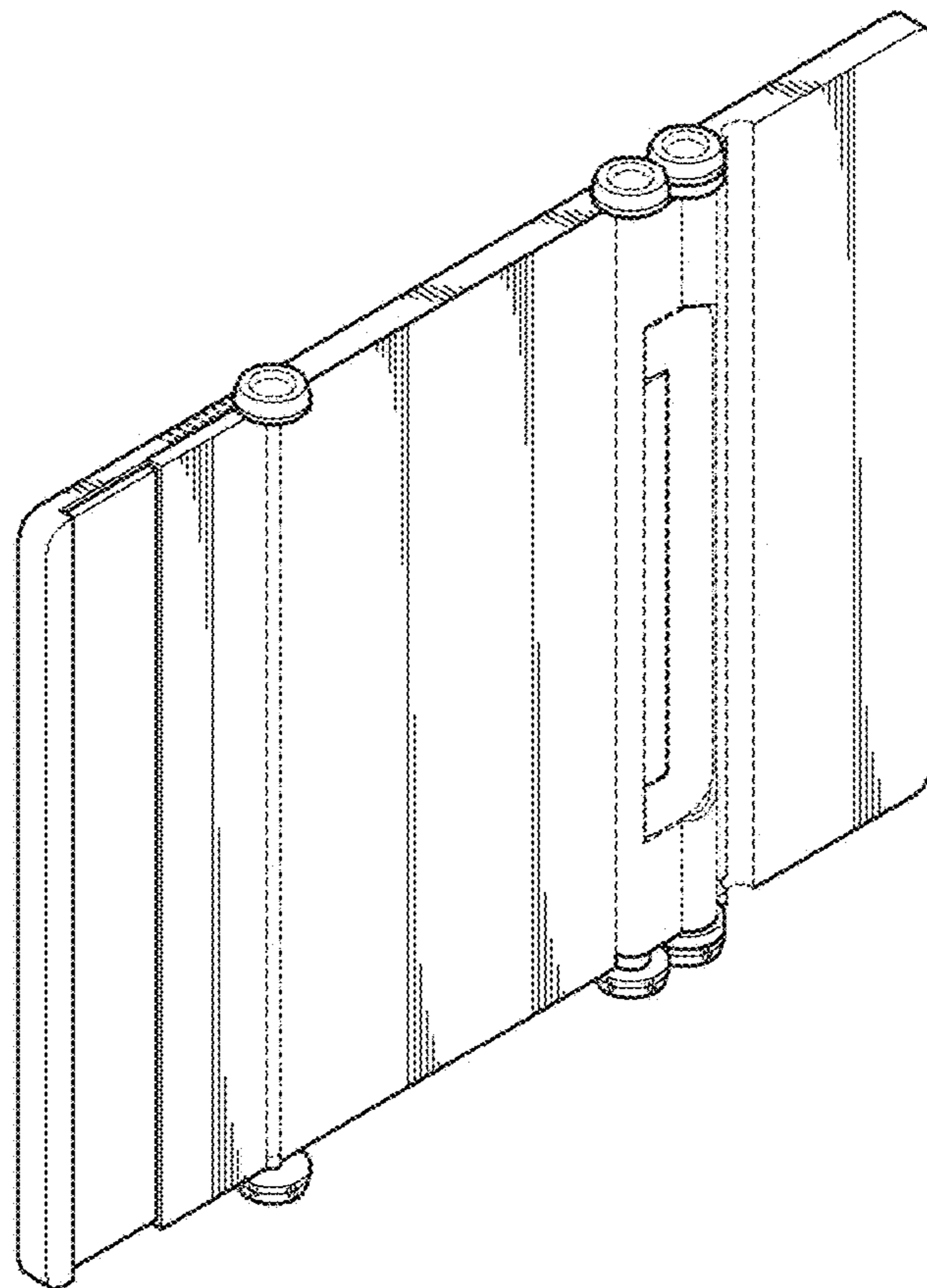

FIG. 15

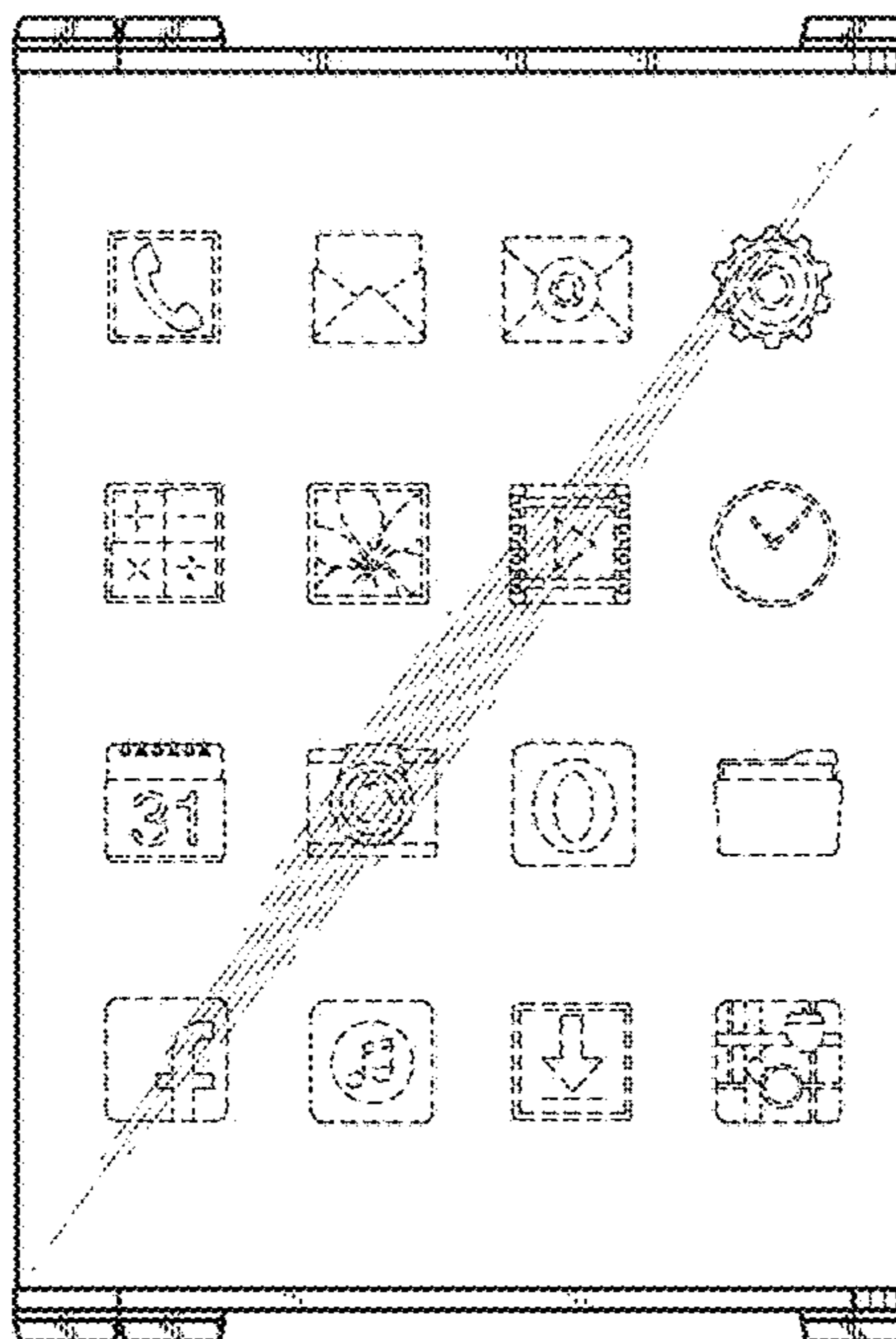

FIG. 16

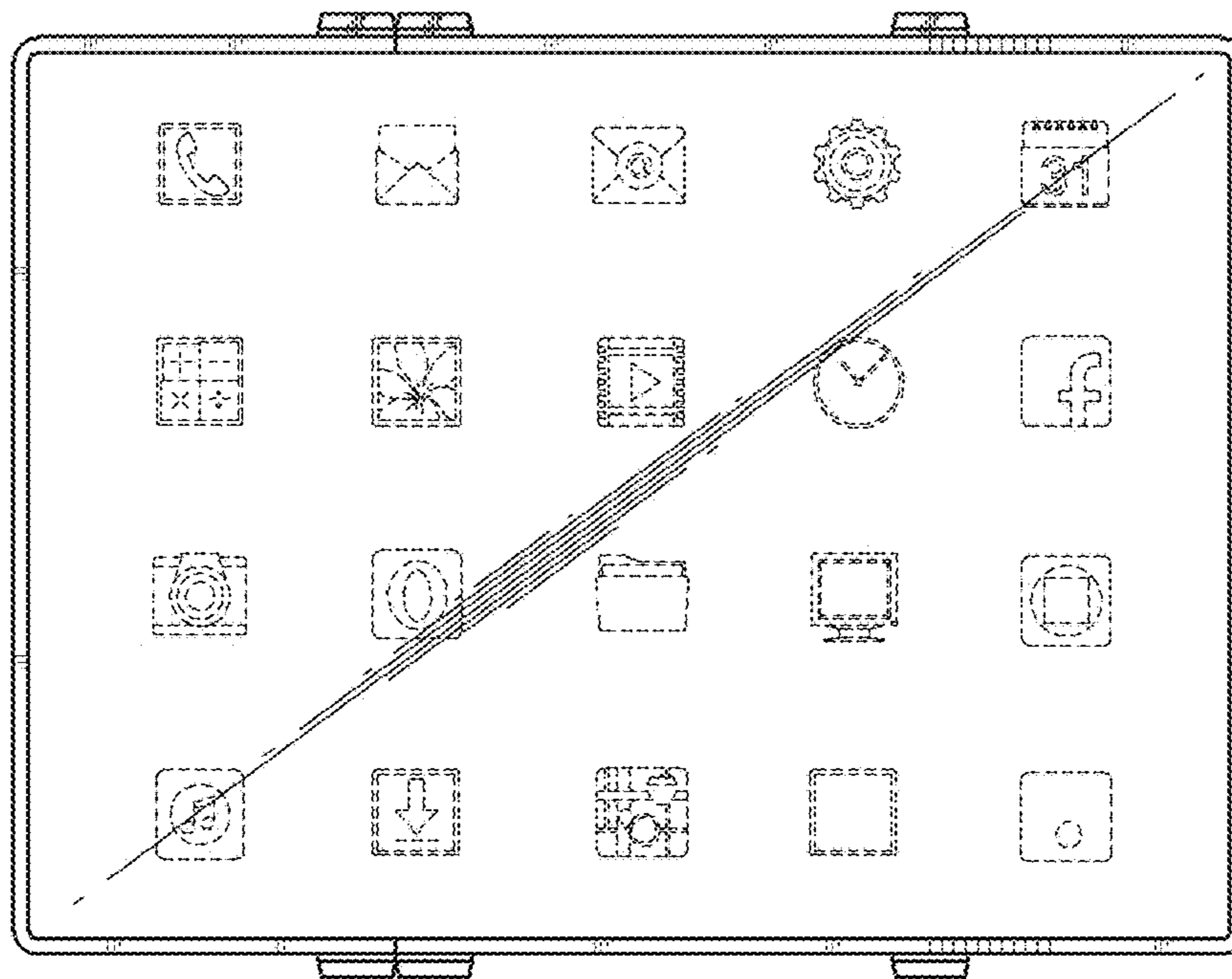

FIG. 17

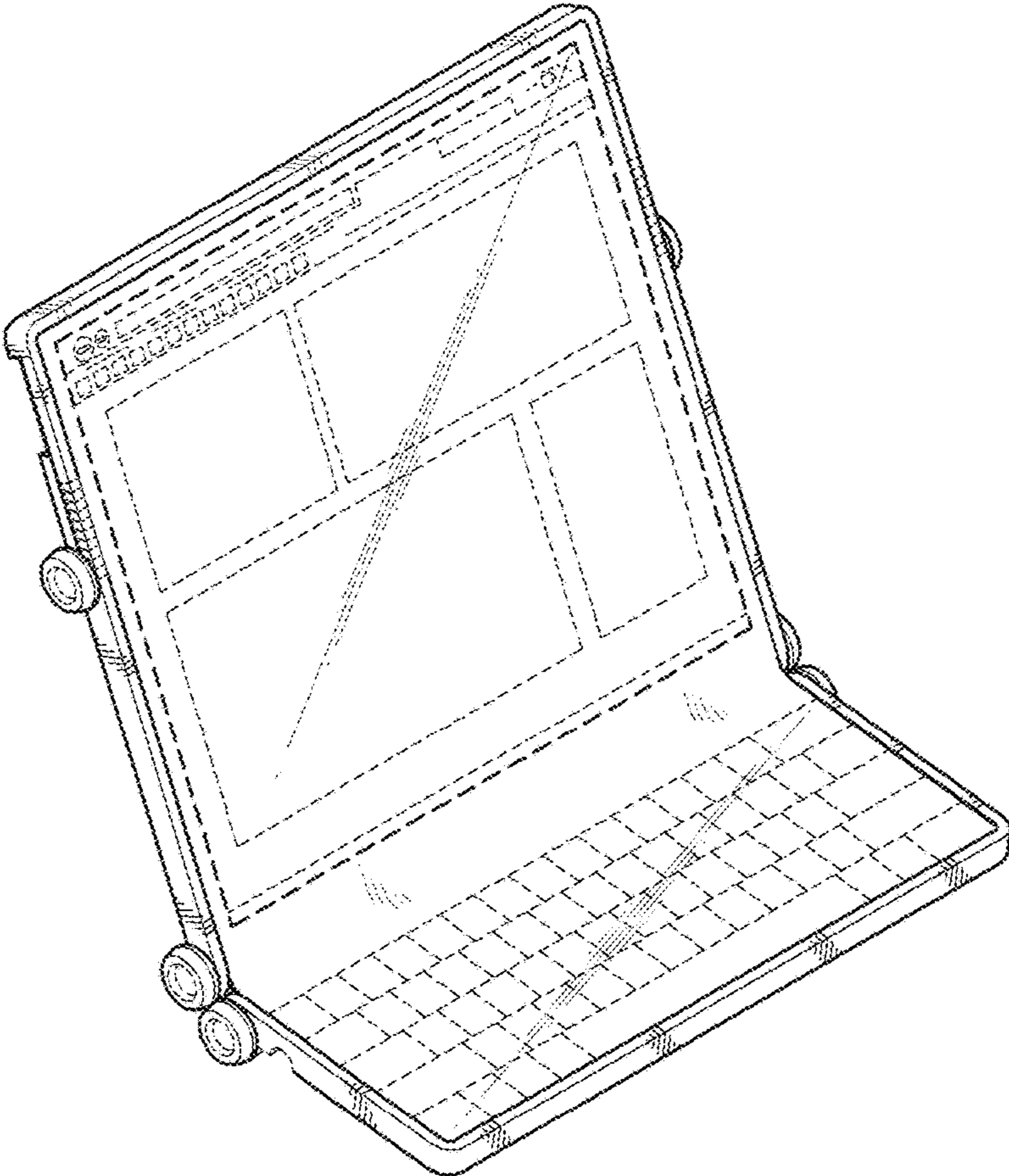

FIG. 18

