



US00D861389S

(12) **United States Design Patent**
Bray

(10) **Patent No.:** **US D861,389 S**
(45) **Date of Patent:** **** Oct. 1, 2019**

(54) **DRESSER**

(71) Applicant: **Blu Dot Design & Manufacturing, Inc.**, Minneapolis, MN (US)
(72) Inventor: **B. Bradshaw Bray**, Minneapolis, MN (US)

(73) Assignee: **Blu Dot Design & Manufacturing, Inc.**, Minneapolis, MN (US)

(**) Term: **15 Years**

(21) Appl. No.: **29/629,148**

(22) Filed: **Dec. 12, 2017**

(51) **LOC (12) Cl.** **06-04**

(52) **U.S. Cl.**
USPC **D6/671**

(58) **Field of Classification Search**
USPC D6/657, 659, 661, 663, 669, 671, 671.1, D6/683.1, 672, 673, 675
CPC A47B 31/00; A47B 46/00; A47B 47/00; A47B 47/022; A47B 47/05; A47B 47/02; A47B 47/04; A47B 47/0066; A47B 47/024; A47B 55/00; A47B 71/00; A47B 67/00; A47B 67/02; A47B 67/04; A47B 73/00; A47B 81/00; A47B 43/00; A47B 43/04; A47B 45/00; A47B 61/00; A47B 61/06; A47B 79/00; A47F 3/00; A47F 3/001; A47F 3/005; A47F 3/0434; A47F 5/08; A47F 7/0078

See application file for complete search history.

(56) **References Cited**

U.S. PATENT DOCUMENTS

2,893,311 A	11/1883	Selby
D97,309 S	4/1935	Stoltz
D98,366 S	1/1936	Pumphrey
D164,614 S	9/1951	Wallace
D165,241 S	11/1951	Porter
2,696,419 A	12/1954	Wallance et al.
D184,935 S	4/1959	Herrmann
D186,115 S	9/1959	Church

(Continued)

OTHER PUBLICATIONS

Houzz. <https://www.houzz.com/product/120934809-ingrid-mid-century-modern-dresser-with-6-drawers-white-midcentury-dressers>. "Ingrid Mid Century Modern Dresser With 6 Drawers, White." Date unknown: Viewed Apr. 2019 (Year: 2019).*

(Continued)

Primary Examiner — R. Johnson

(74) *Attorney, Agent, or Firm* — Fredrikson & Byron, P.A.

(57) **CLAIM**

I claim the ornamental design for a dresser, as shown and described.

DESCRIPTION

FIG. 1 is a front perspective view of a dresser showing the new design;
FIG. 2 is a front elevational view thereof;
FIG. 3 is a rear elevational view thereof;
FIG. 4 is a first side elevational view thereof; the second side elevational view, opposite the first side elevational view, being a mirror image thereof;
FIG. 5 is a top plan view thereof; and
FIG. 6 is a bottom plan view thereof.
FIG. 7 is an enlarged perspective view of the portion identified in FIG. 1, showing one of the four holes of the dresser, the other three holes being identical thereof; and,
FIG. 8 is a sectional view taken along line 8-8 in FIG. 2, which runs through the four holes of the dresser, each hole being symmetric about the line 8-8 such that the cross-section of each hole opposite line 8-8 is a mirror image of the cross-section of each hole shown in FIG. 8.
Where included, broken lines showing environment or structure are for illustrative purposes only and form no part of the claimed design.

1 Claim, 6 Drawing Sheets

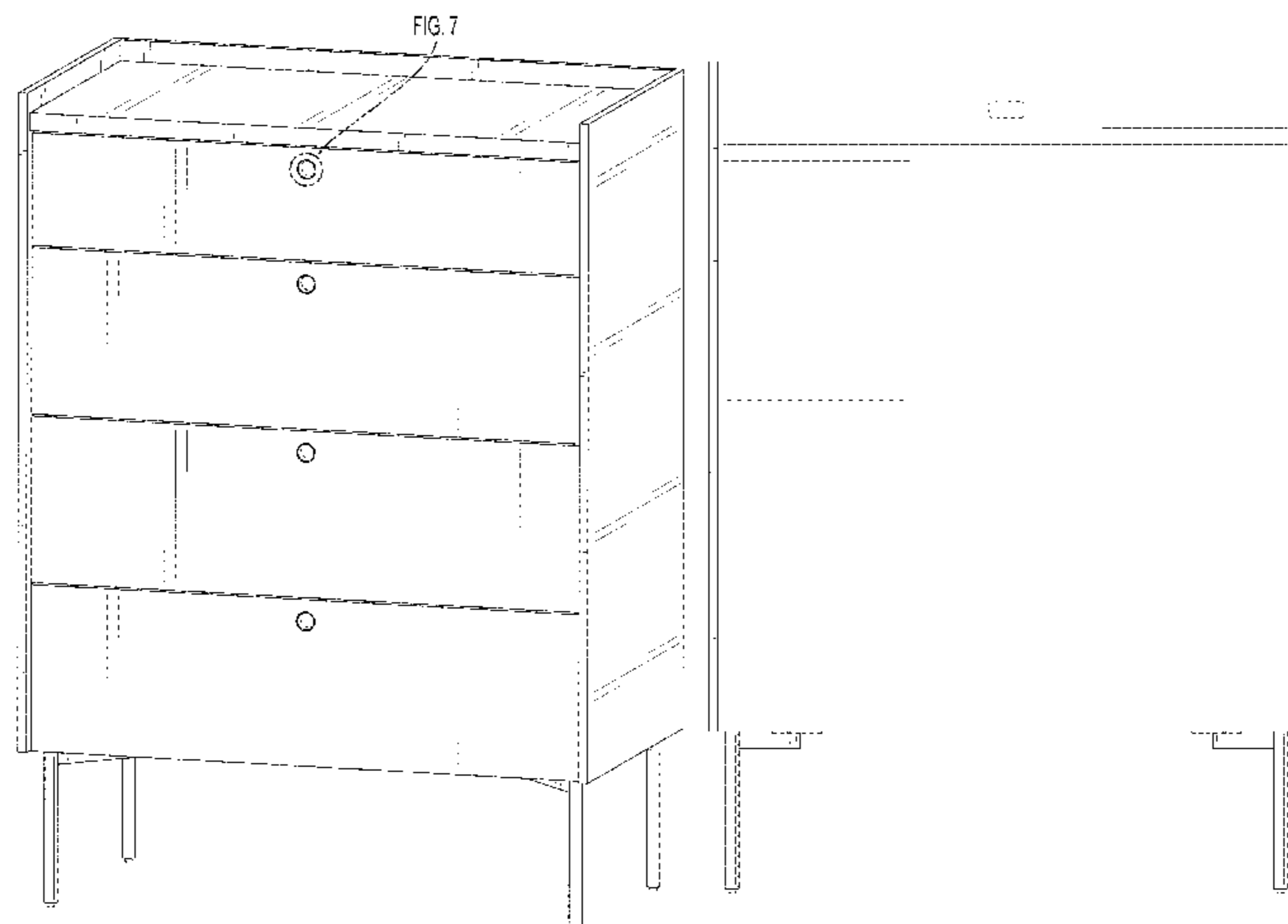

(56)

References Cited

U.S. PATENT DOCUMENTS

D188,197 S 6/1960 Swarts
 D193,516 S 9/1962 Deaton
 D193,717 S 10/1962 Deaton
 3,700,300 A 10/1972 Davis et al.
 D234,386 S 2/1975 Hodges
 3,971,608 A 7/1976 Gans
 D241,213 S 8/1976 Fertleman
 D267,532 S 1/1983 Platner
 D293,521 S 1/1988 Handler et al.
 D304,980 S 12/1989 Bush et al.
 D336,392 S 6/1993 Whalen
 D394,171 S * 5/1998 De Blaay D6/671.1
 D401,080 S * 11/1998 Zaidman D6/671
 D401,443 S 11/1998 Zaidman
 D420,230 S 2/2000 Wanek et al.
 D427,453 S 7/2000 Lacroix et al.
 D427,806 S 7/2000 Lacroix et al.
 D439,076 S 3/2001 Mathieu et al.
 D440,430 S 4/2001 Hutton
 D499,274 S 12/2004 Juneau et al.
 D519,750 S 5/2006 Boudreau
 D526,142 S 8/2006 Schmitt
 D526,814 S 8/2006 Juneau et al.
 D532,624 S 11/2006 Juneau
 D533,732 S 12/2006 Juneau
 D553,879 S 10/2007 Juneau
 D554,893 S 11/2007 Boerner et al.
 D609,496 S * 2/2010 Kanthasamy D6/671.1
 D609,497 S 2/2010 Kanthasamy
 D663,136 S 7/2012 Thompson
 D667,653 S 9/2012 Lenney
 D669,704 S 10/2012 Zambelli
 D784,736 S * 4/2017 Chen D6/671.1

D791,516 S 7/2017 Everson et al.
 D812,935 S 3/2018 Hannoosh et al.
 D815,467 S 4/2018 Hannoosh et al.
 D815,468 S 4/2018 Hannoosh et al.
 D818,745 S 5/2018 Hannoosh et al.
 D825,230 S 8/2018 Massaud
 D825,231 S 8/2018 Massaud
 2009/0277715 A1 * 11/2009 Scharer A47B 47/00
 181/286
 2013/0126452 A1 * 5/2013 Lo A47B 67/04
 211/79
 2014/0231404 A1 * 8/2014 Struck H05B 1/0272
 219/218

OTHER PUBLICATIONS

Chairish. <https://www.chairish.com/product/1209920/edmond-spence-mid-century-modern-bedroom-dresser>. "Edmond Spence Mid Century Modern Bedroom Dresser". Date unknown: Viewed Apr. 2019 (Year: 2019).
 Blu Dot Catalog No. 16, Designed in Minneapolis, Minnesota, Copyright 2015, 44 pages.
 Blu Dot Catalog No. 17, Designed in Minneapolis, Minnesota, Copyright 2015, 52 pages.
 Blu Dot Catalog No. 18, Designed in Minneapolis, Minnesota, Copyright 2015, 51 pages.
 Blu Dot Catalog No. 19, Designed in Minneapolis, Minnesota, Copyright 2016, 54 pages.
 Houzz. <https://www.houzz.com/product/120934809-ingrid-mid-century-modern-dresser-with-6-drawers-white-white-midcentury-dressers>. "Ingrid Mid Century Modern Dresser With 6 Drawers, White.". Date unknown: Viewed Apr. 2019 (Year: 2019).

* cited by examiner

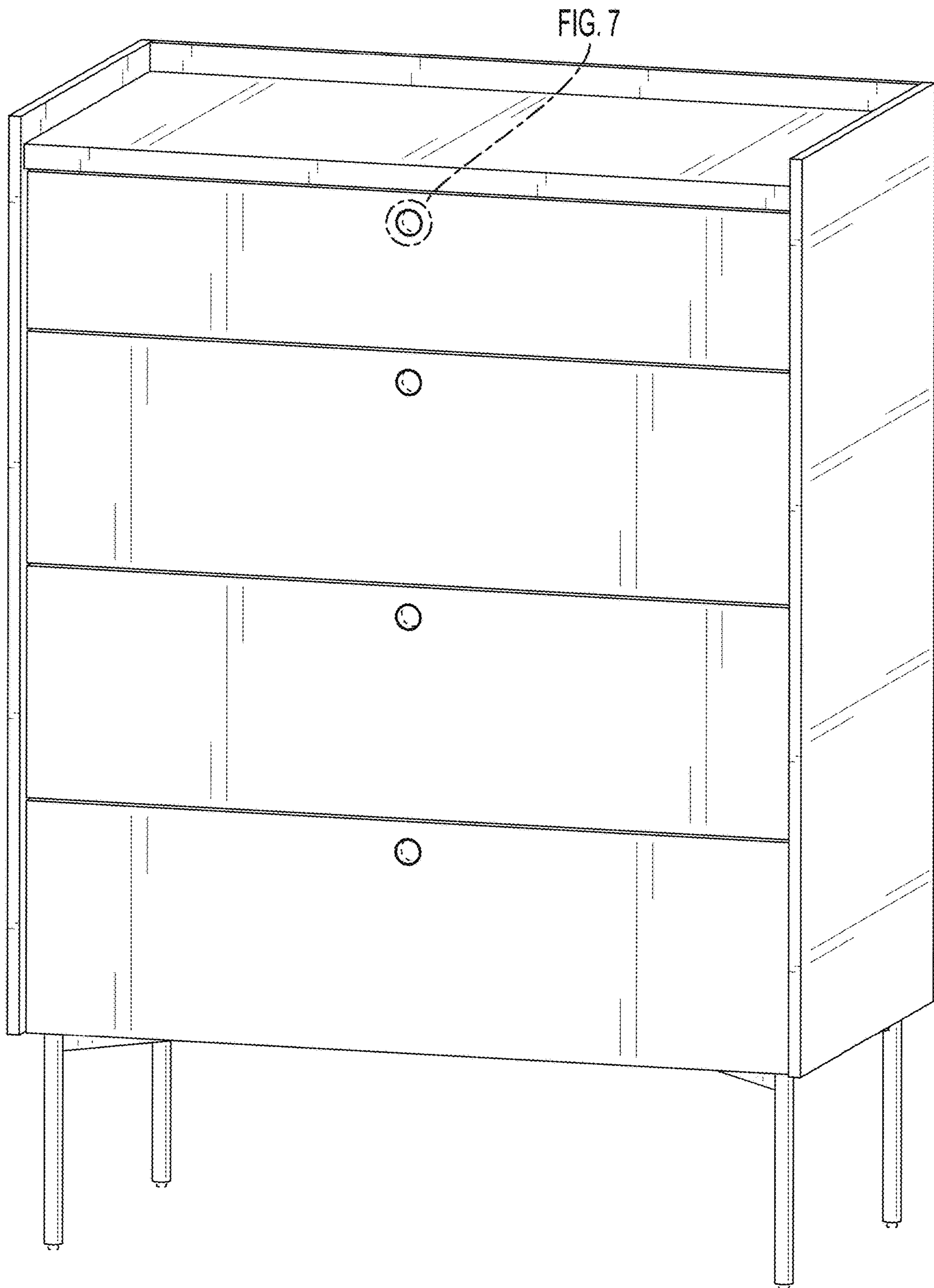

FIG. 1

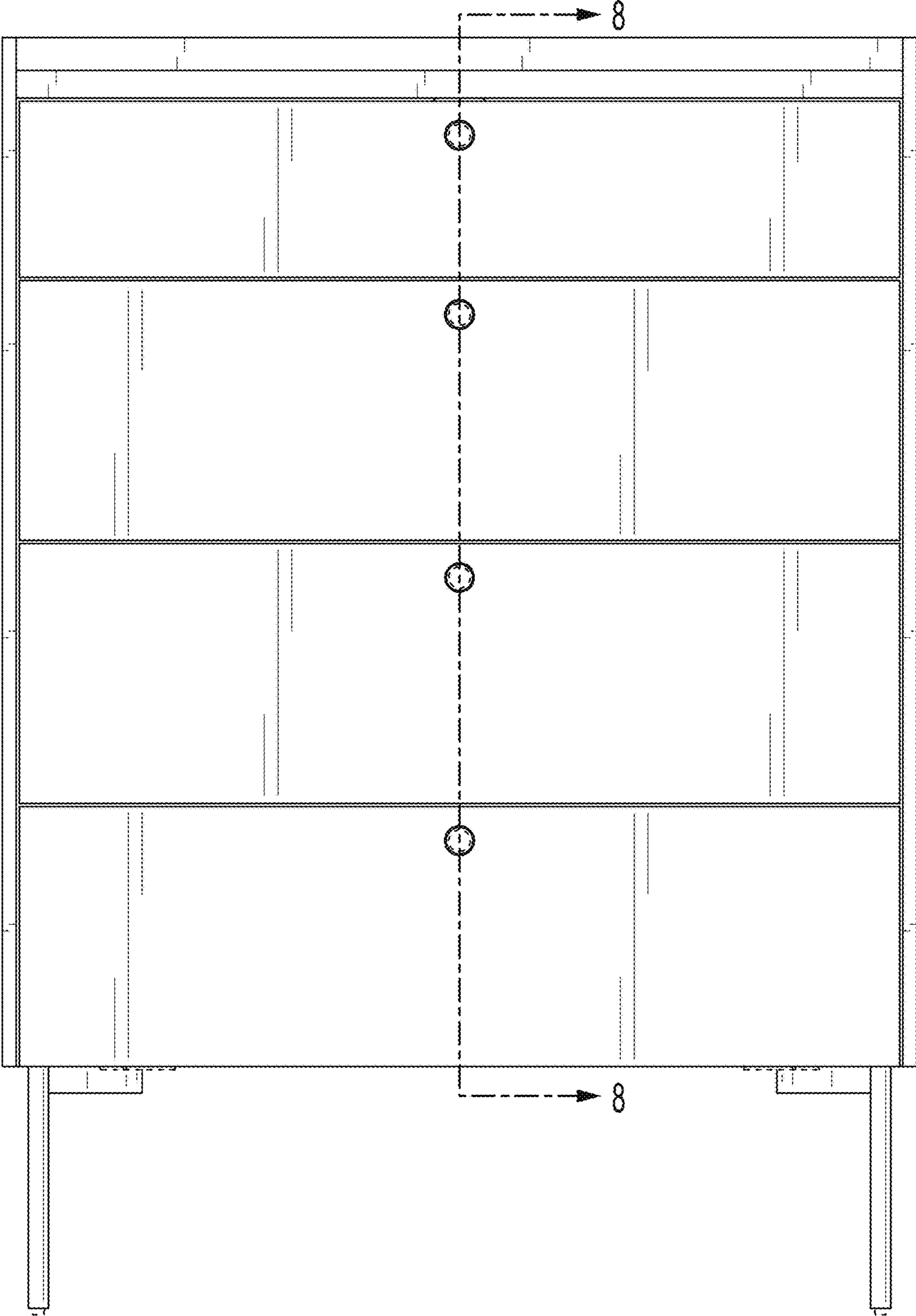

FIG. 2

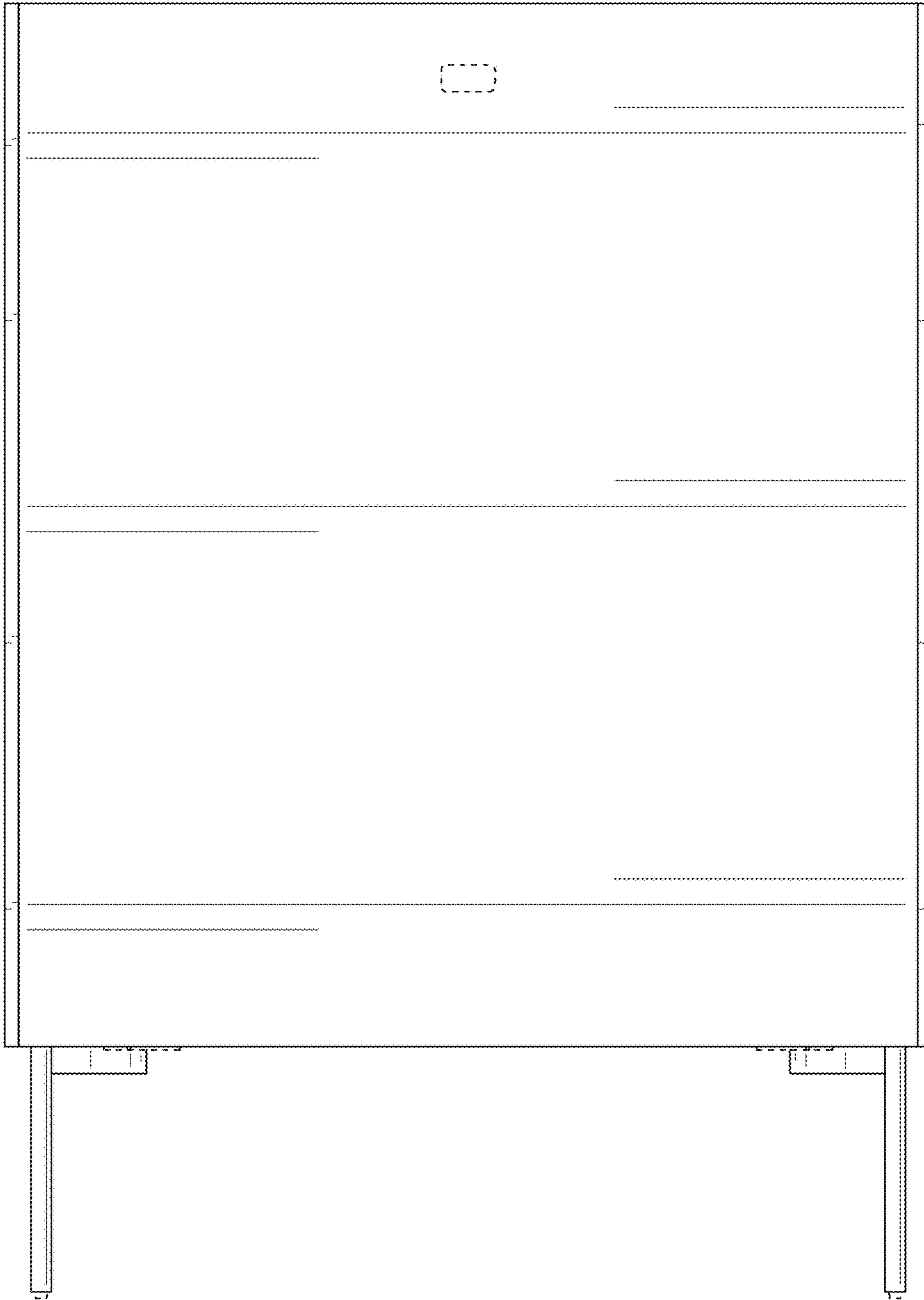

FIG. 3

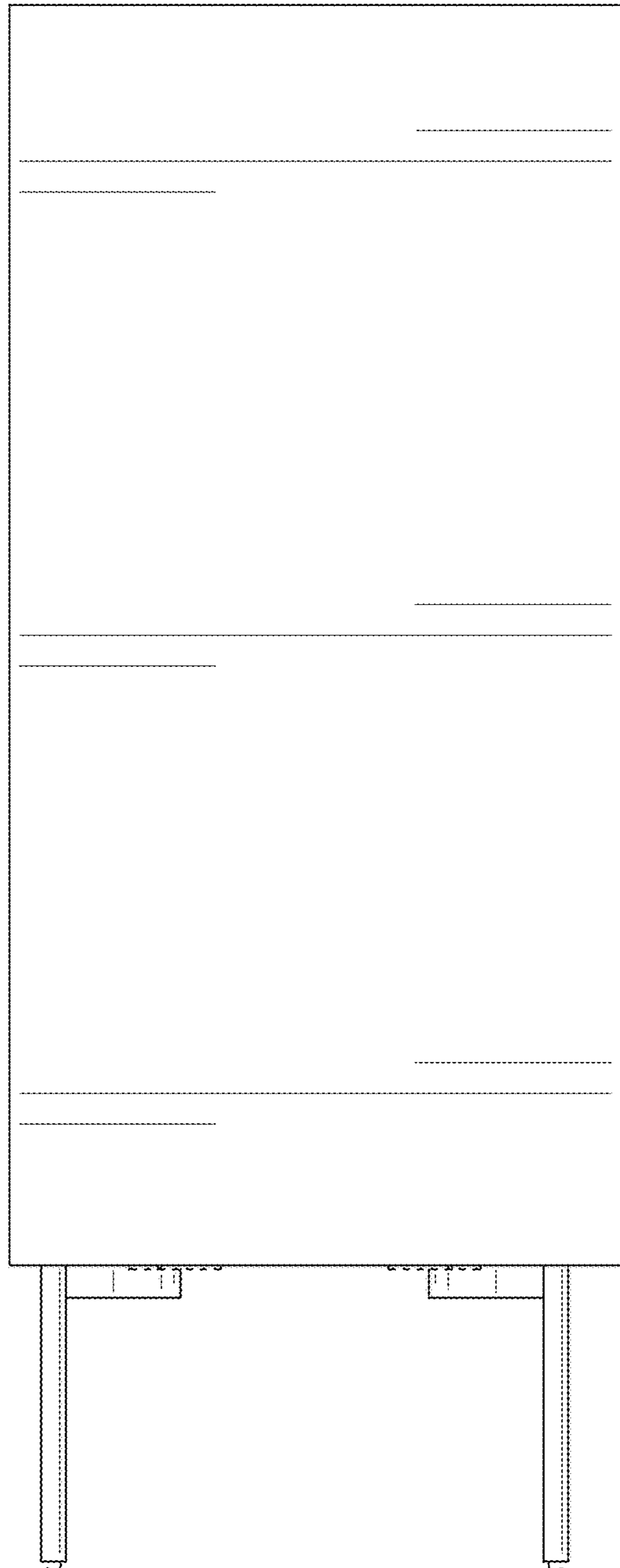

FIG. 4

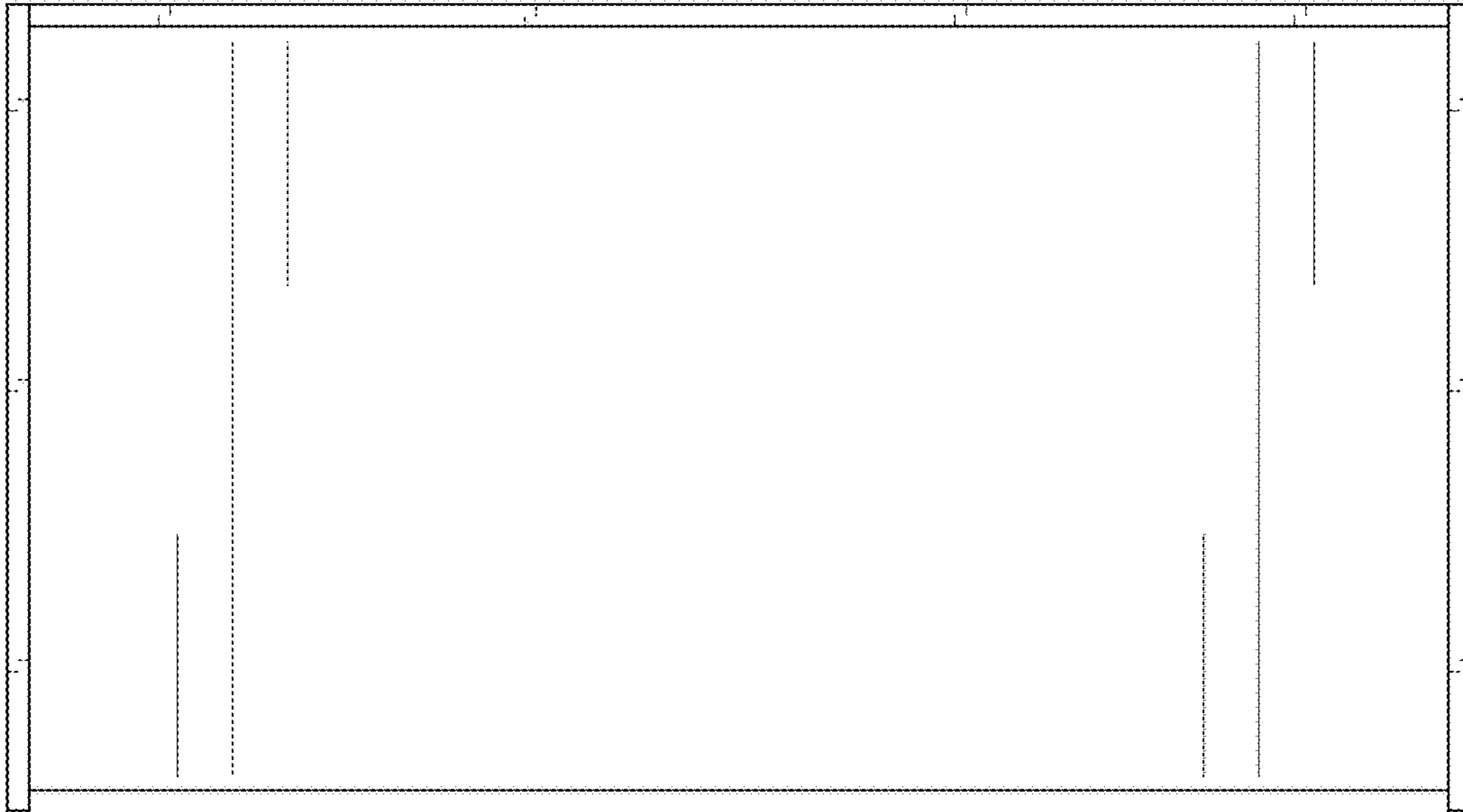

FIG. 5

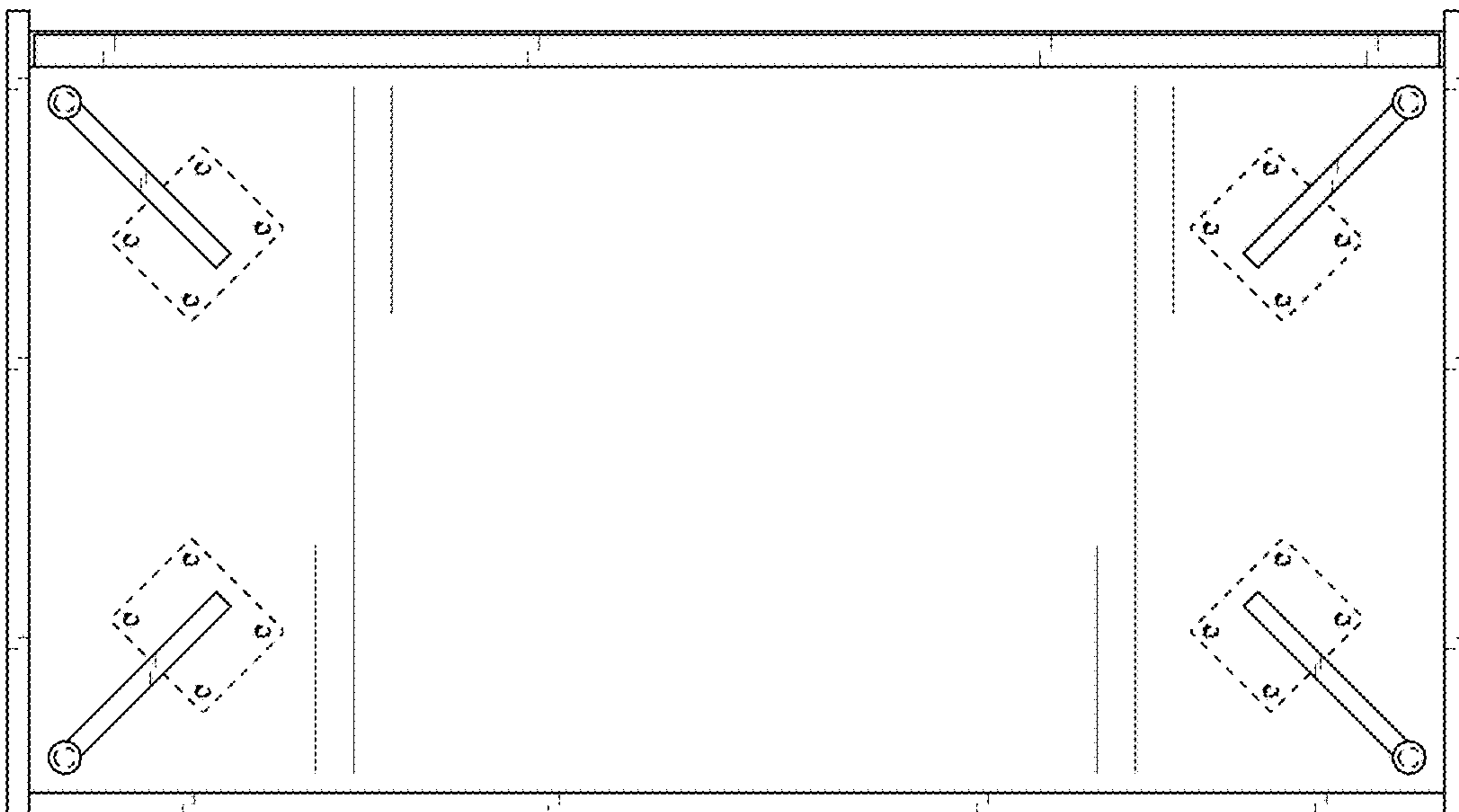

FIG. 6

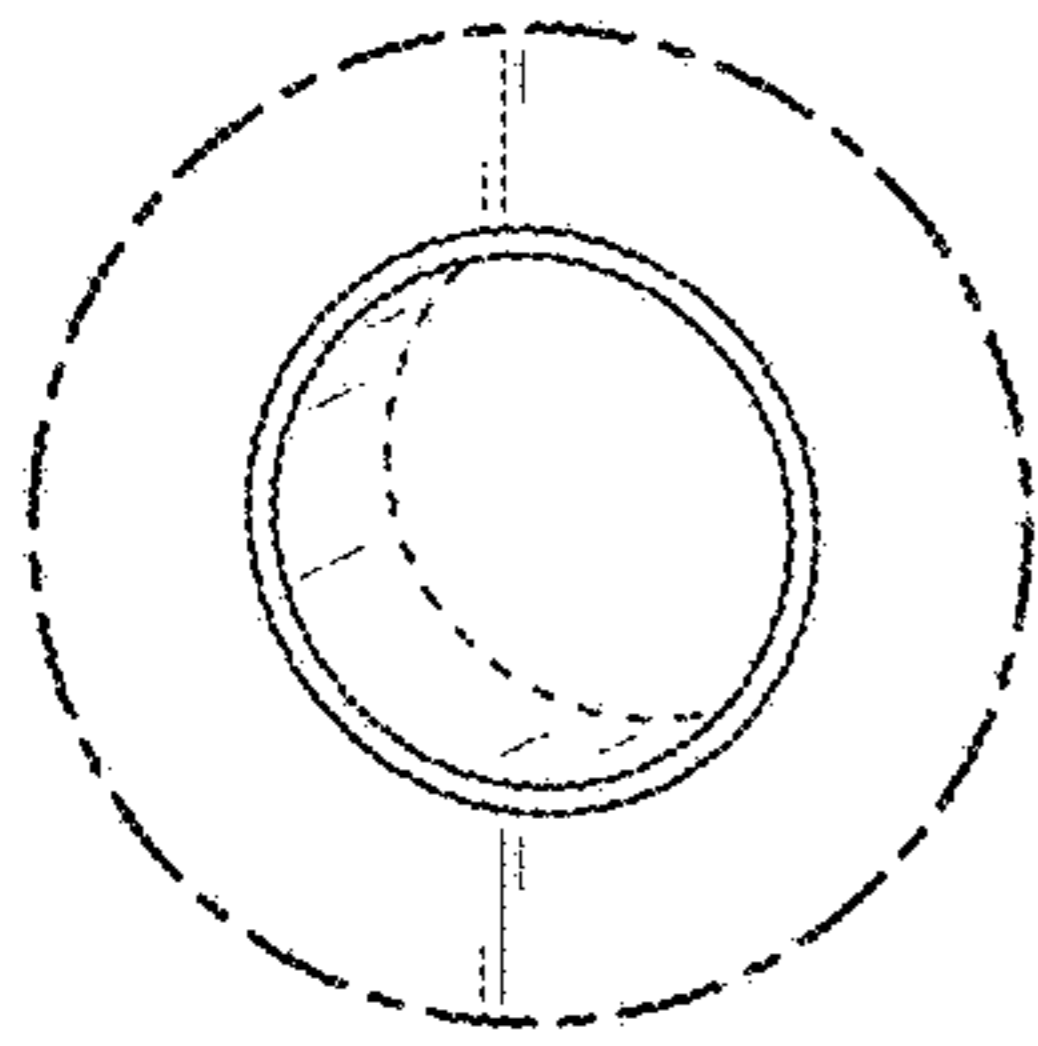

FIG. 7

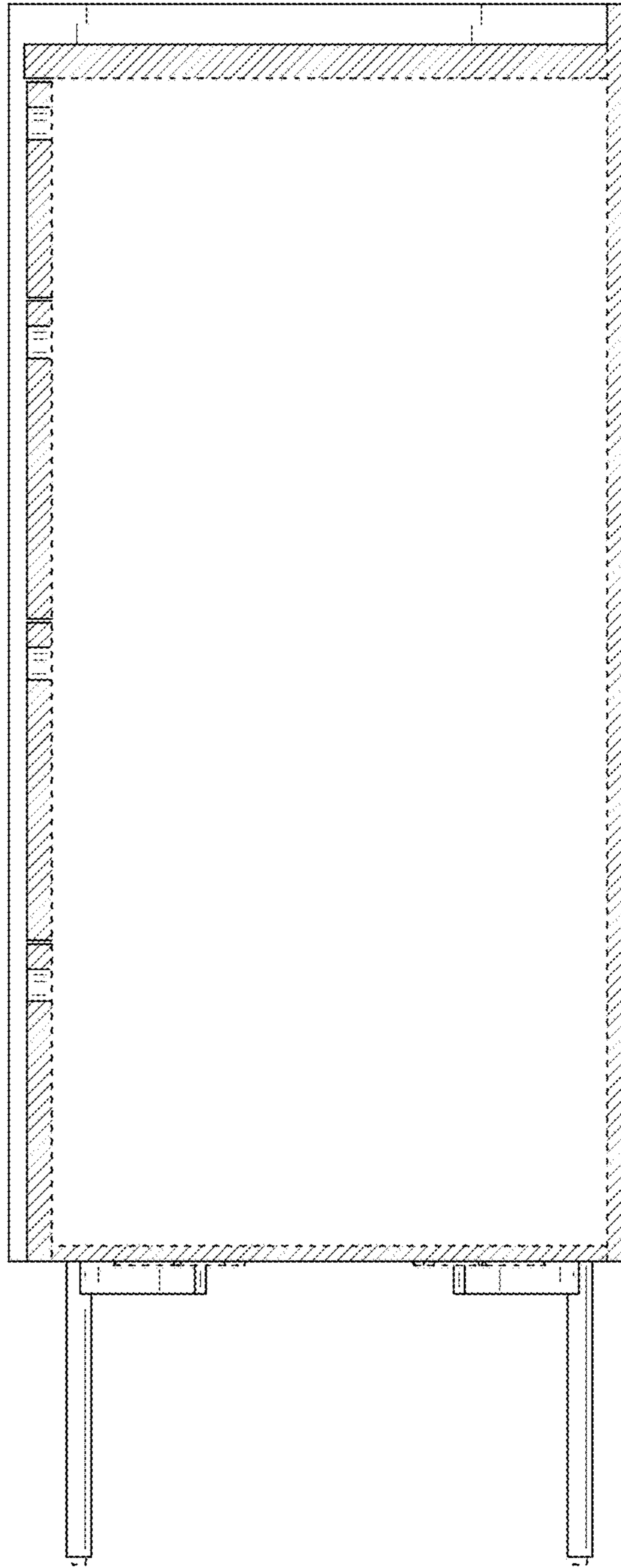

FIG. 8