



US00D861367S

(12) **United States Design Patent**  
**Shen**

(10) **Patent No.:** **US D861,367 S**

(45) **Date of Patent:** **\*\* Oct. 1, 2019**

(54) **OFFICE CHAIR**

(71) Applicant: **NINGBO MEIYING ELECTRONIC TECHNOLOGY CO., LTD**, Ningbo (CN)

(72) Inventor: **Yinuo Shen**, Ningbo (CN)

(73) Assignee: **Ningbo Meiyang Electronic Technology Co., Ltd.** (CN)

(\*\*) Term: **15 Years**

(21) Appl. No.: **29/656,319**

(22) Filed: **Jul. 11, 2018**

(51) **LOC (12) Cl.** ..... **06-01**

(52) **U.S. Cl.**  
USPC ..... **D6/366**

(58) **Field of Classification Search**  
USPC ..... D6/334-336, 356, 364, 365, 366, 367, D6/374, 375, 379, 380, 716, 716.1, 716.3, D6/716.4  
CPC .. A47C 4/028; A47C 7/02; A47C 7/18; A47C 7/38; A47C 7/40; B60N 2/02; B60N 2/20; B60N 2/22; B60N 2/58  
See application file for complete search history.

(56) **References Cited**

**U.S. PATENT DOCUMENTS**

D298,986 S *	12/1988	Carter	.....	D6/356
D317,534 S *	6/1991	Hansel	.....	D6/333
D326,959 S *	6/1992	VanDuser	.....	D6/356
D509,077 S *	9/2005	Beermann	.....	D6/356
D532,211 S *	11/2006	Su	.....	D6/366
D536,543 S *	2/2007	Hsu	.....	D6/356

D542,547 S *	5/2007	Su	.....	D6/366
D549,475 S *	8/2007	Su	.....	D6/356
D612,623 S *	3/2010	Smit	.....	D6/366
D612,641 S *	3/2010	Smit	.....	D6/366
7,753,451 B2 *	7/2010	Maebert	.....	B60N 2/20 297/344.11
D721,897 S *	2/2015	Ritzel	.....	D6/356
D748,926 S *	2/2016	Henstridge	.....	D6/356
D789,699 S *	6/2017	Kumagai	.....	D6/356
D790,240 S *	6/2017	Kumagai	.....	D6/356
D807,072 S *	1/2018	Mao	.....	D6/366
D809,313 S *	2/2018	Mao	.....	D6/366
D811,145 S *	2/2018	Li	.....	D6/716
2011/0057498 A1 *	3/2011	Fujita	.....	B60N 2/58 297/452.18

\* cited by examiner

*Primary Examiner* — Mimosa De

(57) **CLAIM**

The ornamental design for office chair, as shown and described.

**DESCRIPTION**

FIG. 1 is a perspective view of the office chair showing my new design;  
FIG. 2 is a front view thereof;  
FIG. 3 is a back view thereof;  
FIG. 4 is a left side view thereof;  
FIG. 5 is a right side view thereof;  
FIG. 6 is a top view thereof; and,  
FIG. 7 is a bottom view thereof.

The darker broken lines shown on the backrest and seat represent stitching, other lighter broken lines in the drawing illustrate portions of the office chair that form no part of the claimed design.

**1 Claim, 7 Drawing Sheets**

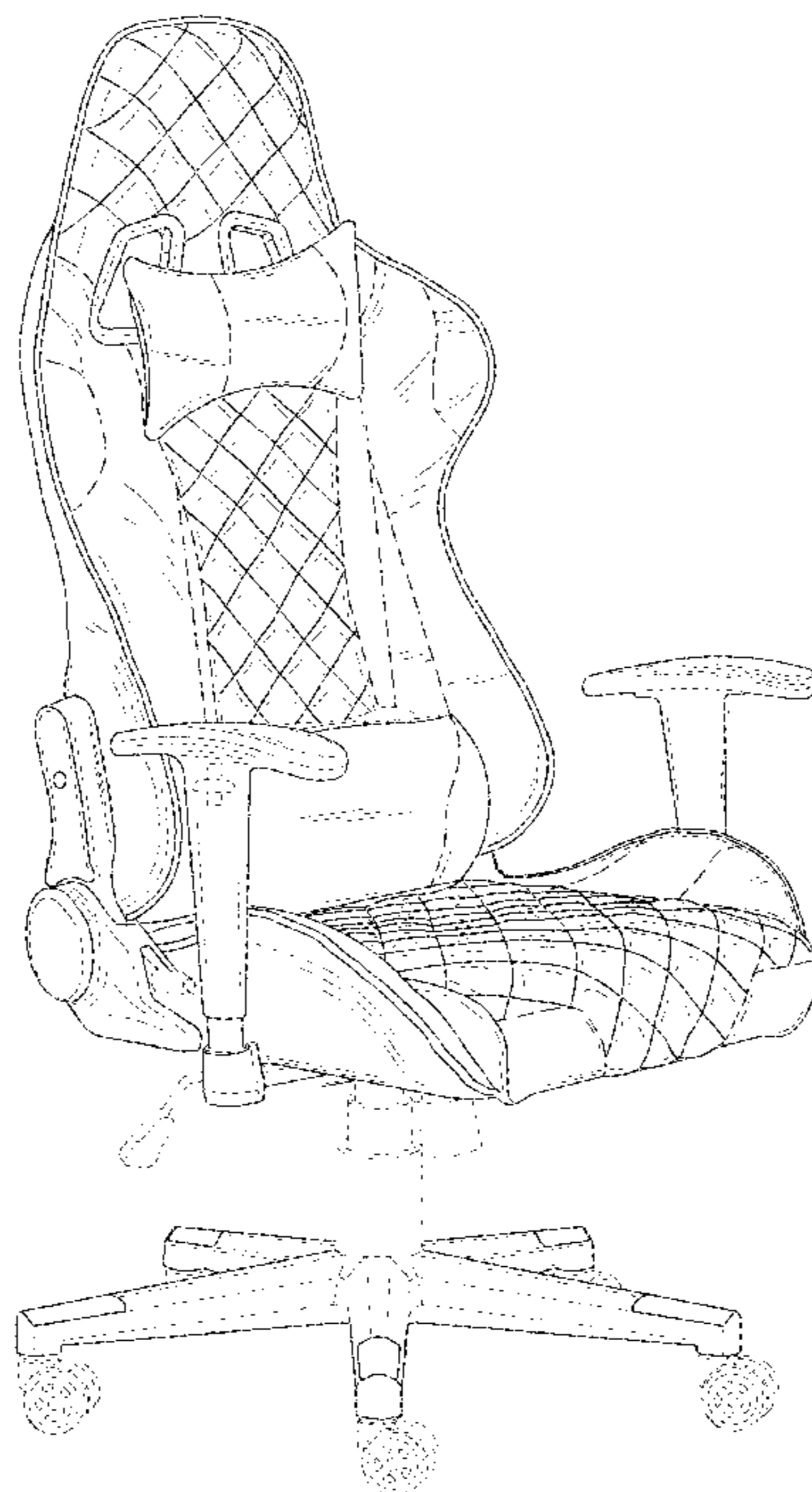

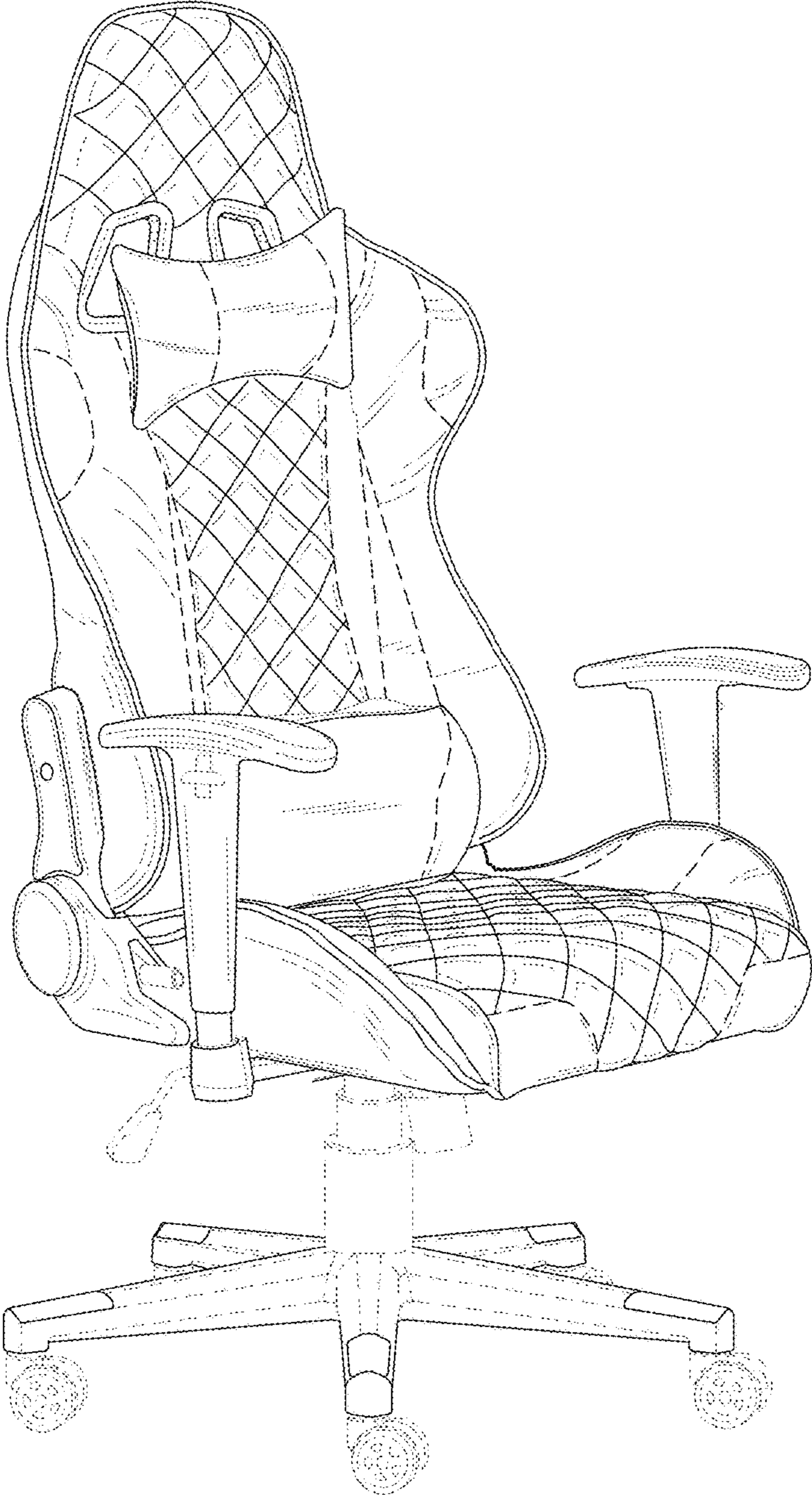

FIG. 1

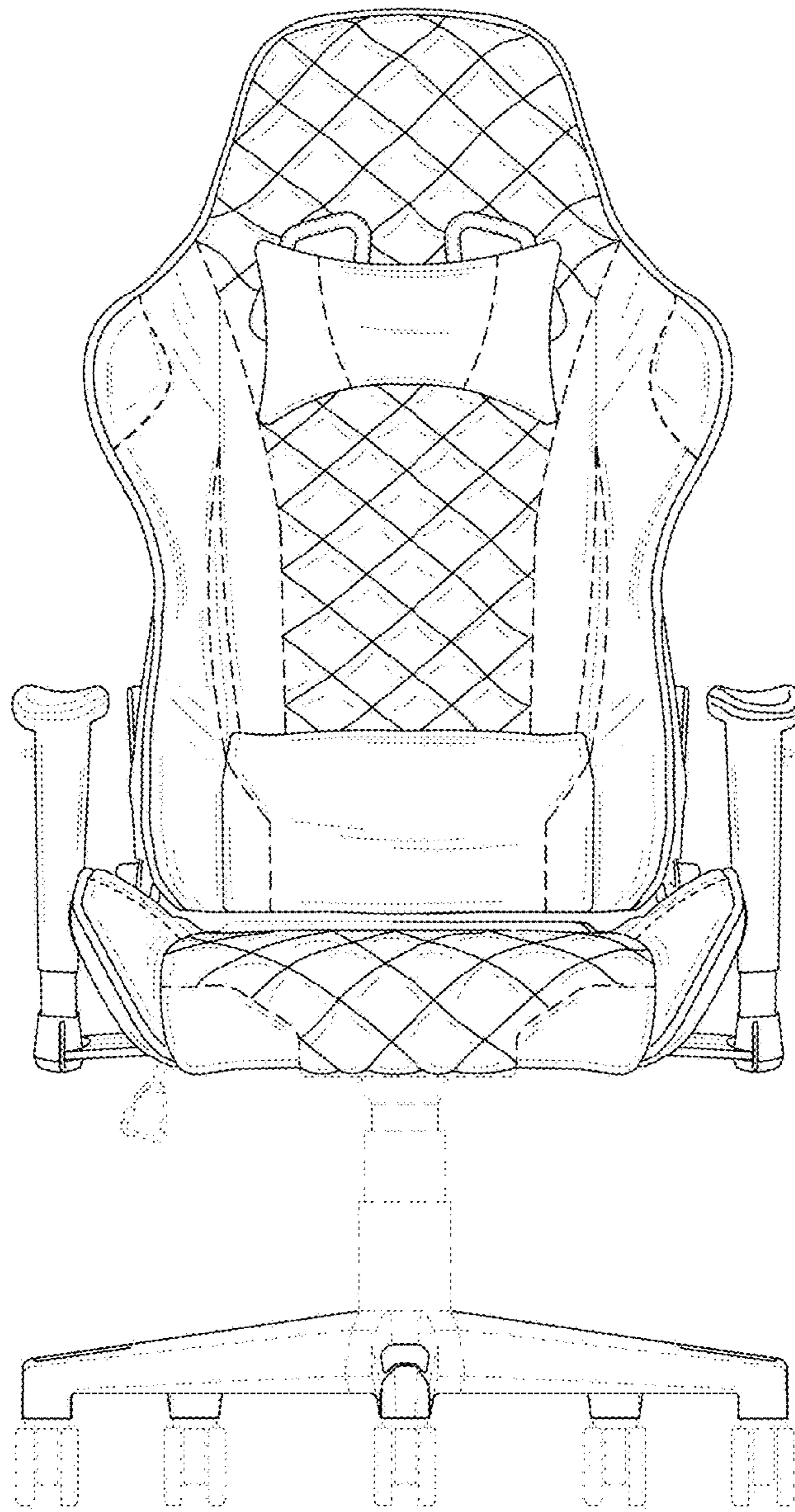

FIG.2



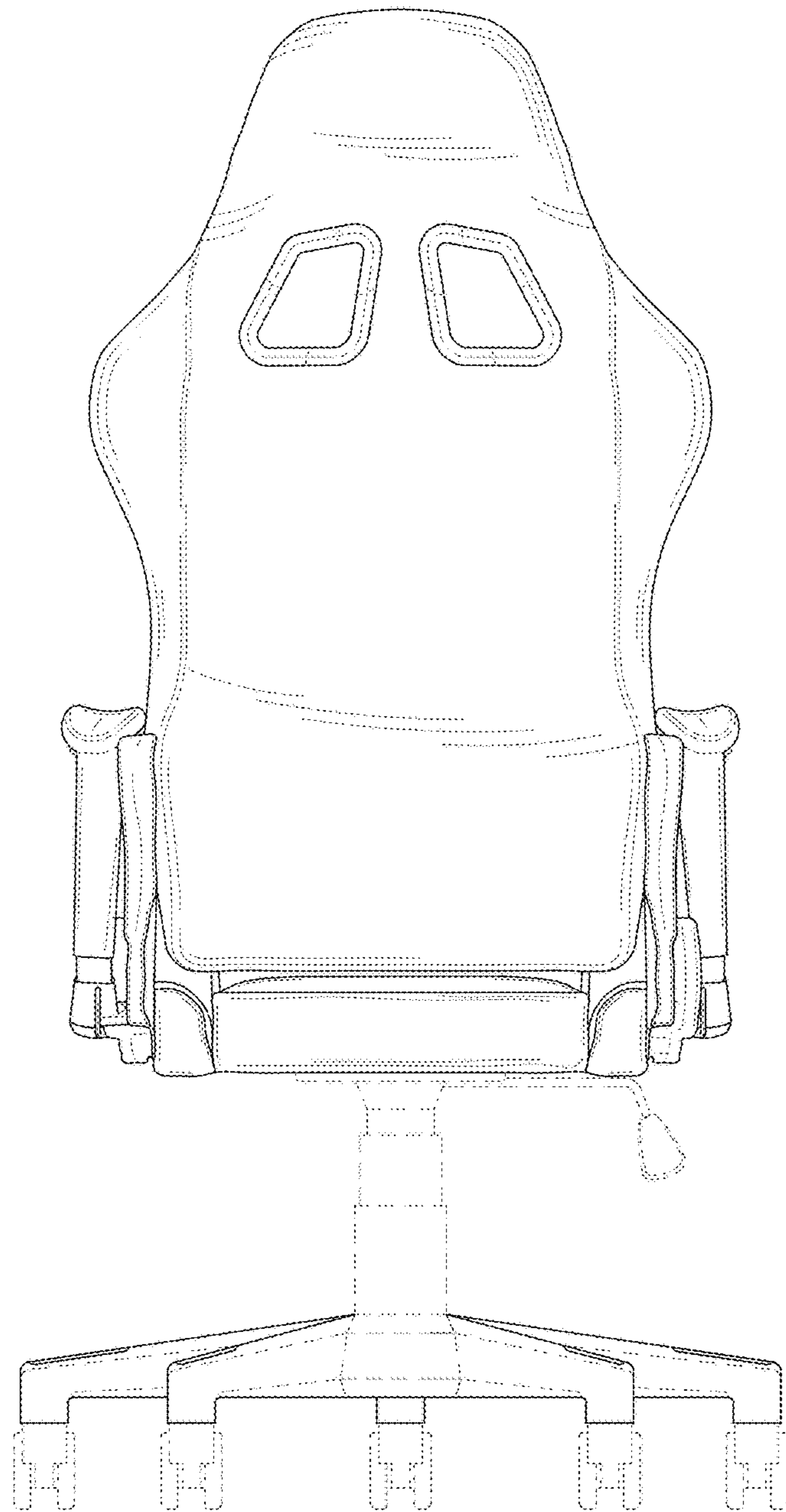

FIG 3

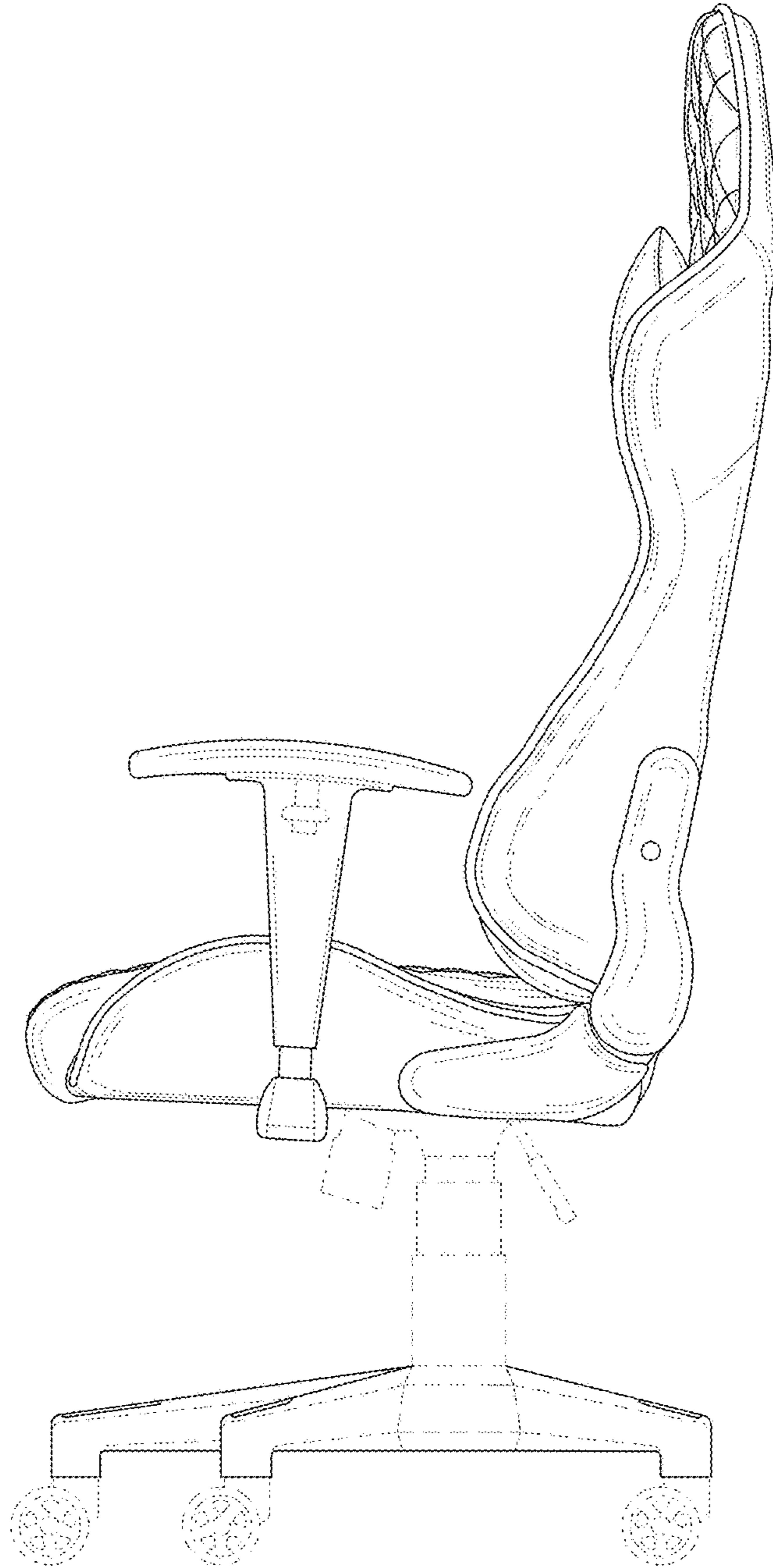

FIG.4

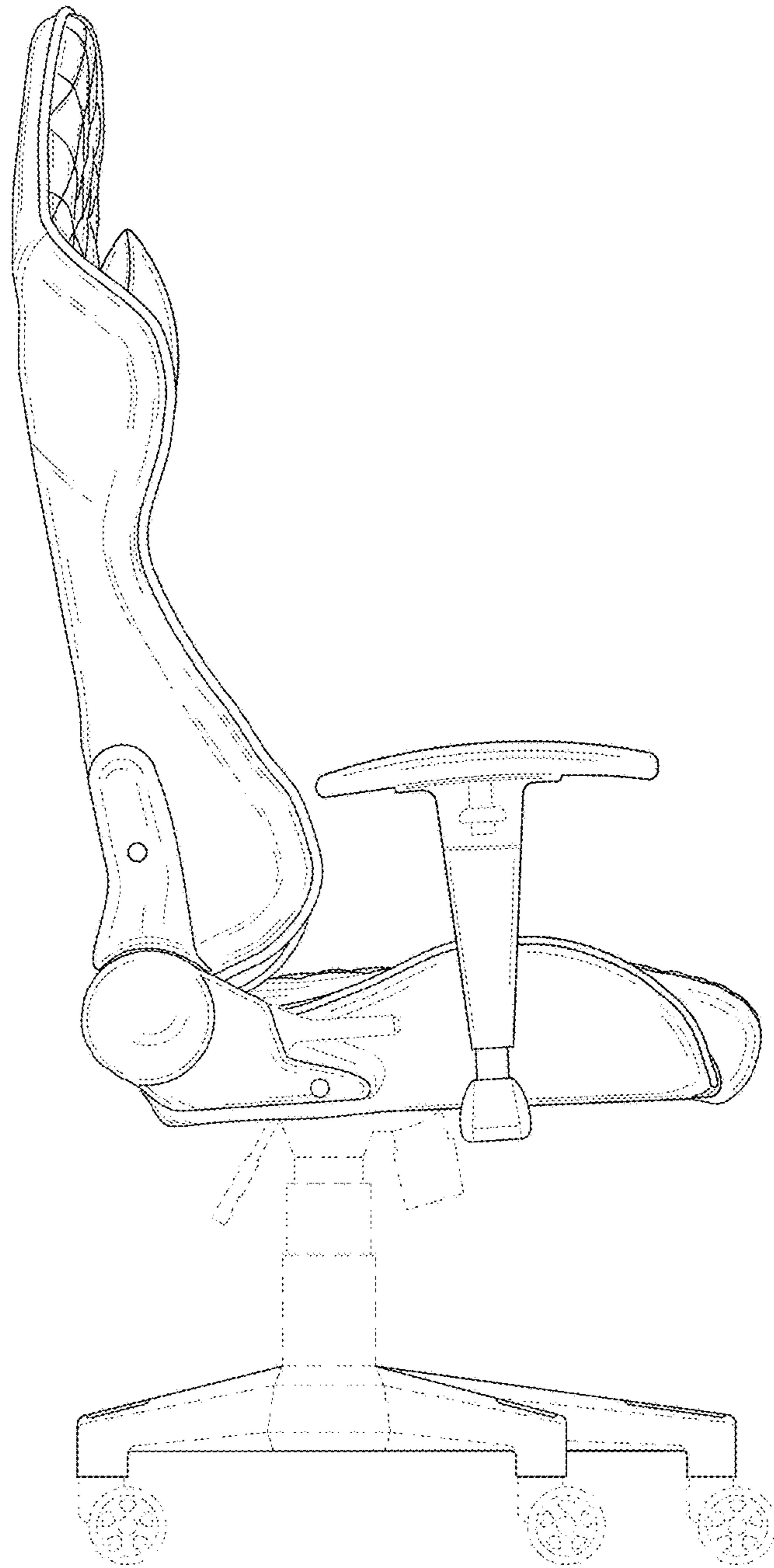

FIG. 5

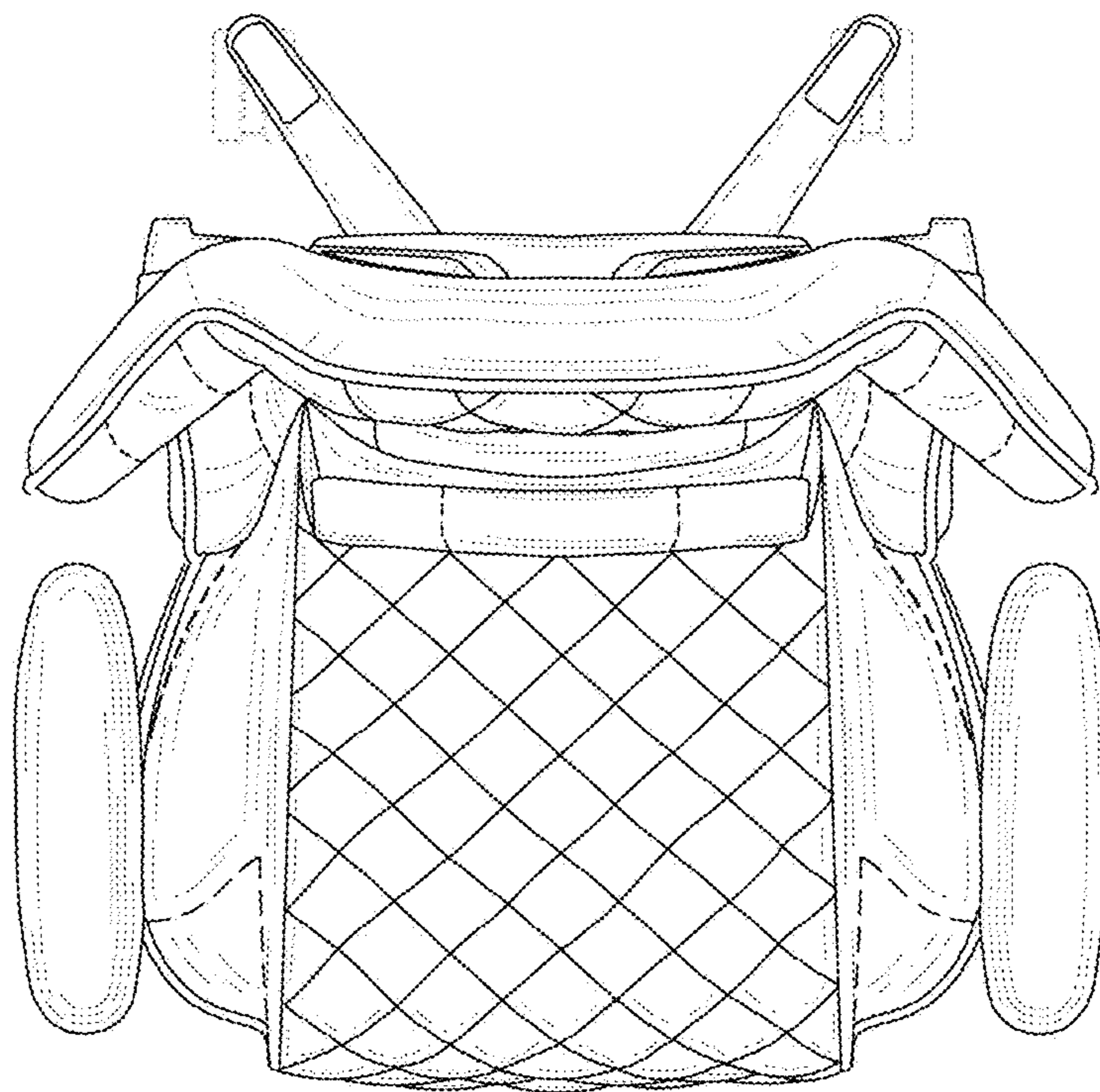

FIG.6

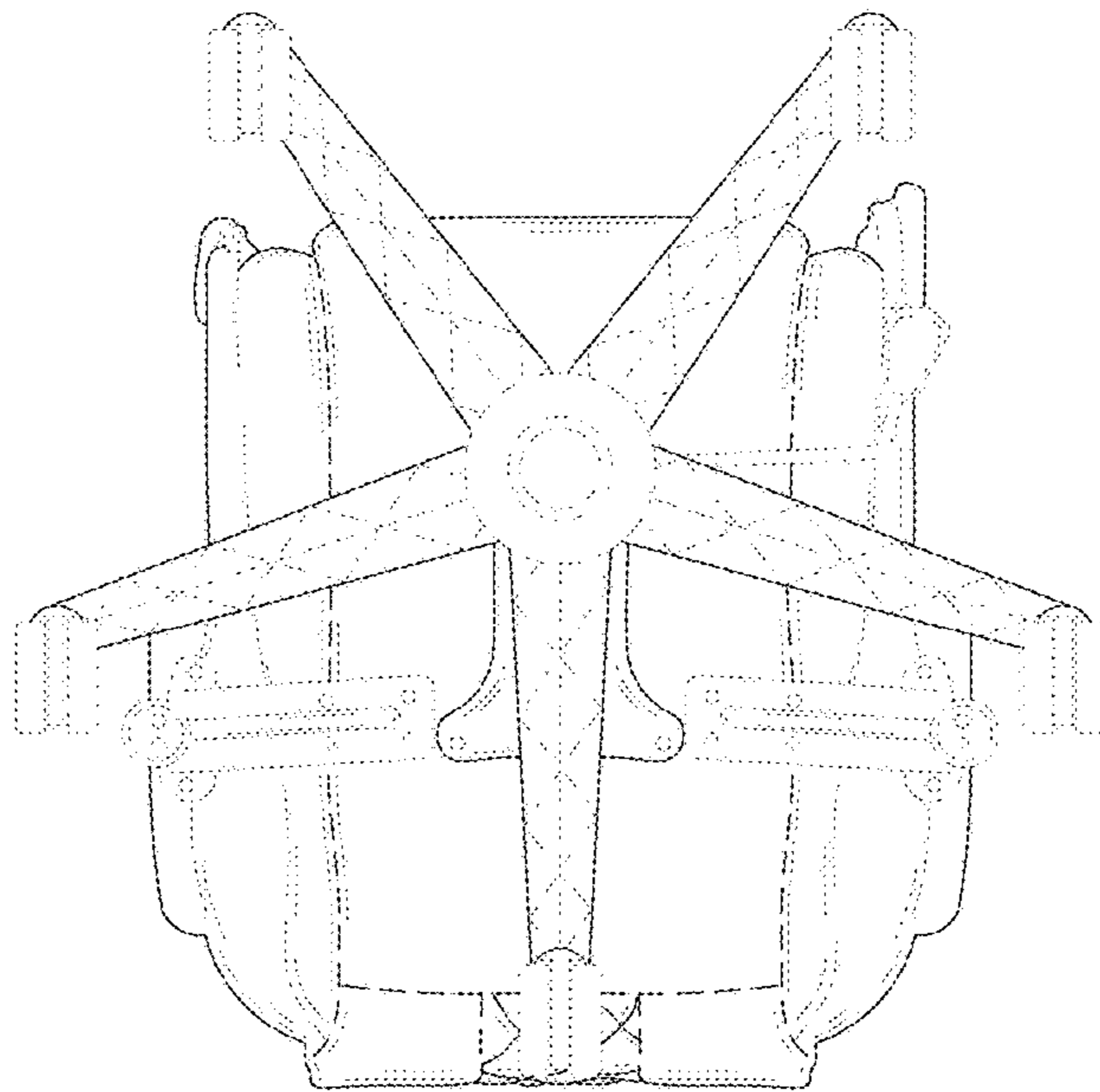

FIG. 7