



US00D861340S

(12) **United States Design Patent**
Deng

(10) **Patent No.:** **US D861,340 S**

(45) **Date of Patent:** **** Oct. 1, 2019**

(54) **GUN BOX**

(71) Applicant: **Guangzhou Sunami Industrial Co. LTD.**, Guangzhou (CN)

(72) Inventor: **Junlin Deng**, Guangzhou (CN)

(73) Assignee: **GUANGZHOU SUNAMI INDUSTRIAL CO. LTD.**, Guangzhou (CN)

(**) Term: **15 Years**

(21) Appl. No.: **29/633,528**

(22) Filed: **Jan. 15, 2018**

(51) **LOC (12) Cl.** **03-01**

(52) **U.S. Cl.**
USPC **D3/262**

(58) **Field of Classification Search**
USPC D3/201, 204, 221-223, 254, 262, 273,
D3/276, 282, 294, 315
CPC ... A01K 97/00-08; F41C 33/02; F41C 33/06;
F41C 33/00; A45C 11/24; A45C 13/00;
A45C 13/001; B65D 85/00
See application file for complete search history.

(56) **References Cited**

U.S. PATENT DOCUMENTS

D163,210 S *	5/1951	Long	D3/204
3,138,306 A *	6/1964	Jules Bare	F41C 33/06
				206/317
D222,688 S *	11/1971	Canton	D3/254
D225,383 S *	12/1972	Eisele	D3/292
D228,494 S *	10/1973	Smith	D3/262
D247,993 S *	5/1978	Calzone, III	D3/204
D278,189 S *	4/1985	Frydenberg	D3/262
4,531,632 A *	7/1985	Weber	G10G 7/005
				206/14
D318,371 S *	7/1991	Leverette	D3/260
D320,113 S *	9/1991	VanSkiver	D3/262

D336,984 S *	7/1993	VanSkiver	D3/262
D347,322 S *	5/1994	Fiore	D3/262
D358,255 S *	5/1995	Sharp	D3/262
D359,392 S *	6/1995	Bellington	D3/262
D362,116 S *	9/1995	Bellington	D3/262
D384,807 S *	10/1997	Dougherty	D3/204
D407,557 S *	4/1999	Jones	D3/276
D475,196 S *	6/2003	VanSkiver	D3/262
D483,178 S *	12/2003	Fiore, Jr.	D3/254
D486,960 S *	2/2004	Sauey	D3/262
D506,062 S *	6/2005	Whalen	D3/262
D559,544 S *	1/2008	Allen	D3/254
D559,545 S *	1/2008	Allen	D3/254

(Continued)

Primary Examiner — Mitchell I. Siegel

(74) *Attorney, Agent, or Firm* — Gokalp Bayramoglu

(57) **CLAIM**

The ornamental design for a gun box, as shown and described.

DESCRIPTION

FIG. 1 is a front view of a gun box showing my new design; FIG. 2 is a rear view thereof; FIG. 3 is a top view thereof; FIG. 4 is a bottom view thereof; FIG. 5 is a perspective view thereof; FIG. 6 is an enlarged detailed view of the indicated area "6" in the FIG. 1; FIG. 7 is an enlarged detailed view of the indicated area "7" in the FIG. 2; FIG. 8 is an enlarged detailed view of the indicated area "8" in the FIG. 3; FIG. 9 is an enlarged detailed view of the indicated area "9" in the FIG. 4; FIG. 10 is an enlarged right side view thereof; and, FIG. 11 is an enlarged left side view thereof. The broken lines defining an enlargement portion of the design form no part of the claimed design.

1 Claim, 11 Drawing Sheets

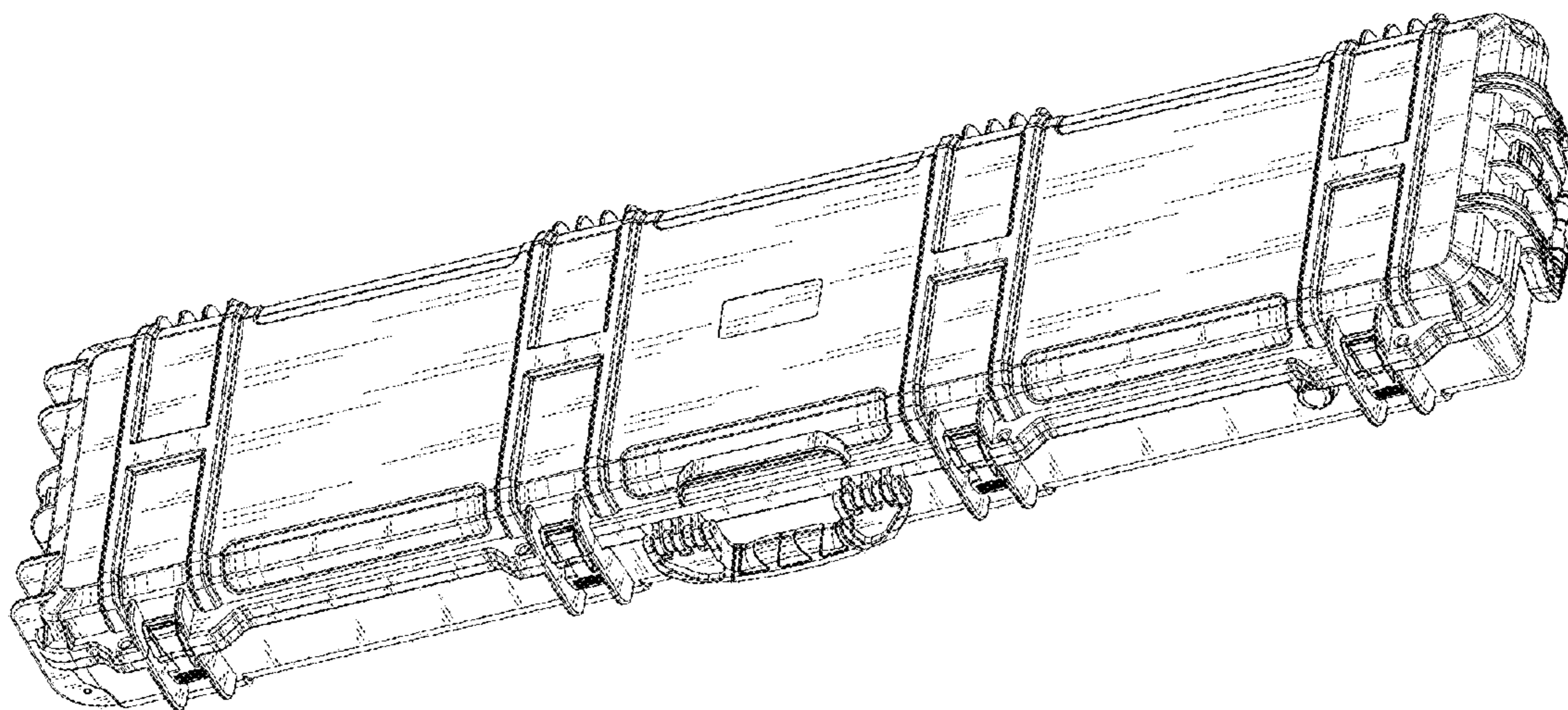

(56)

References Cited

U.S. PATENT DOCUMENTS

7,546,920	B1 *	6/2009	Horn	F41C 33/06 206/317
D609,455	S *	2/2010	Coppiardi	D3/204
D630,426	S *	1/2011	Wilfer	D3/204
D642,373	S *	8/2011	Decarlo	D3/204
D664,763	S *	8/2012	Negrini	D3/262
D684,762	S *	6/2013	Cho	D3/204
D744,749	S *	12/2015	Negrini	D3/262
D779,822	S *	2/2017	Grenier	D3/279
D789,085	S *	6/2017	Jacobson	D3/262
D805,026	S *	12/2017	Anderson	D13/102
D822,991	S *	7/2018	Sorokin	D3/262

* cited by examiner

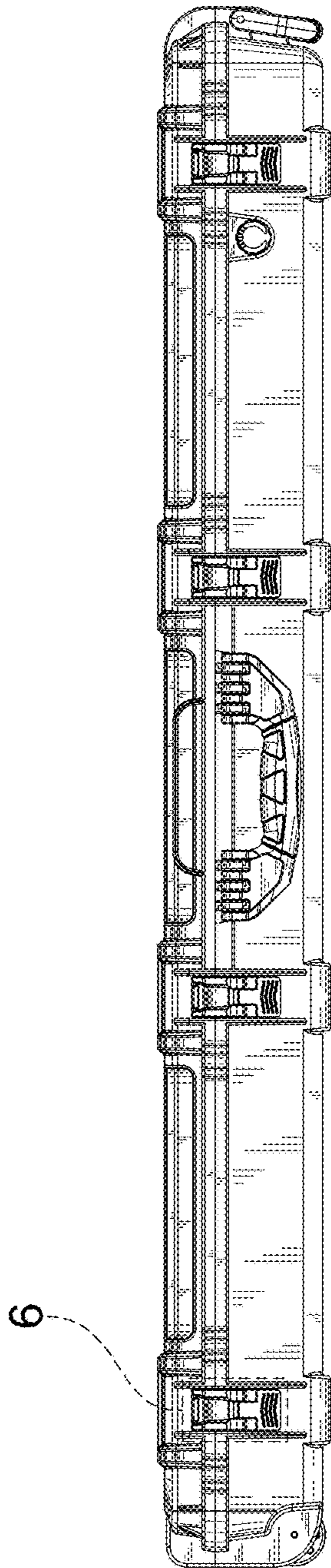

Fig. 1

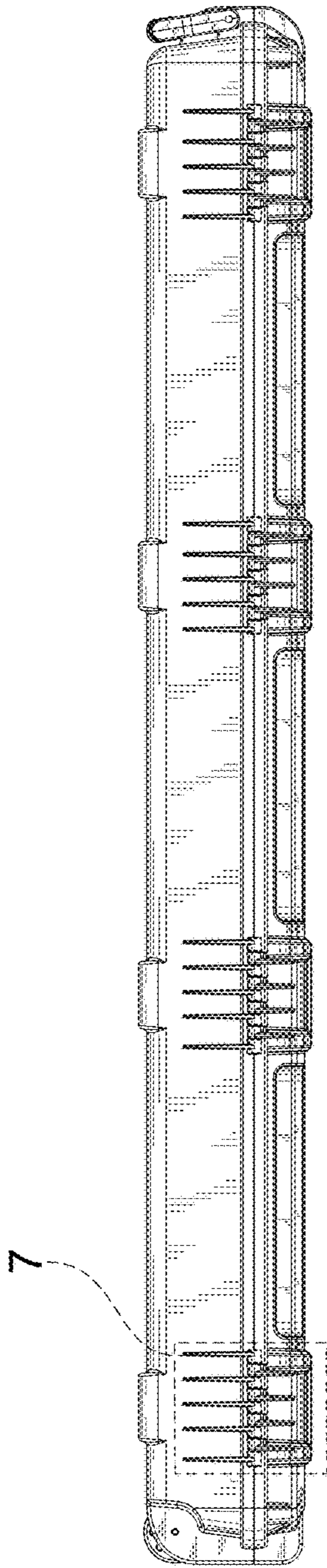

Fig. 2

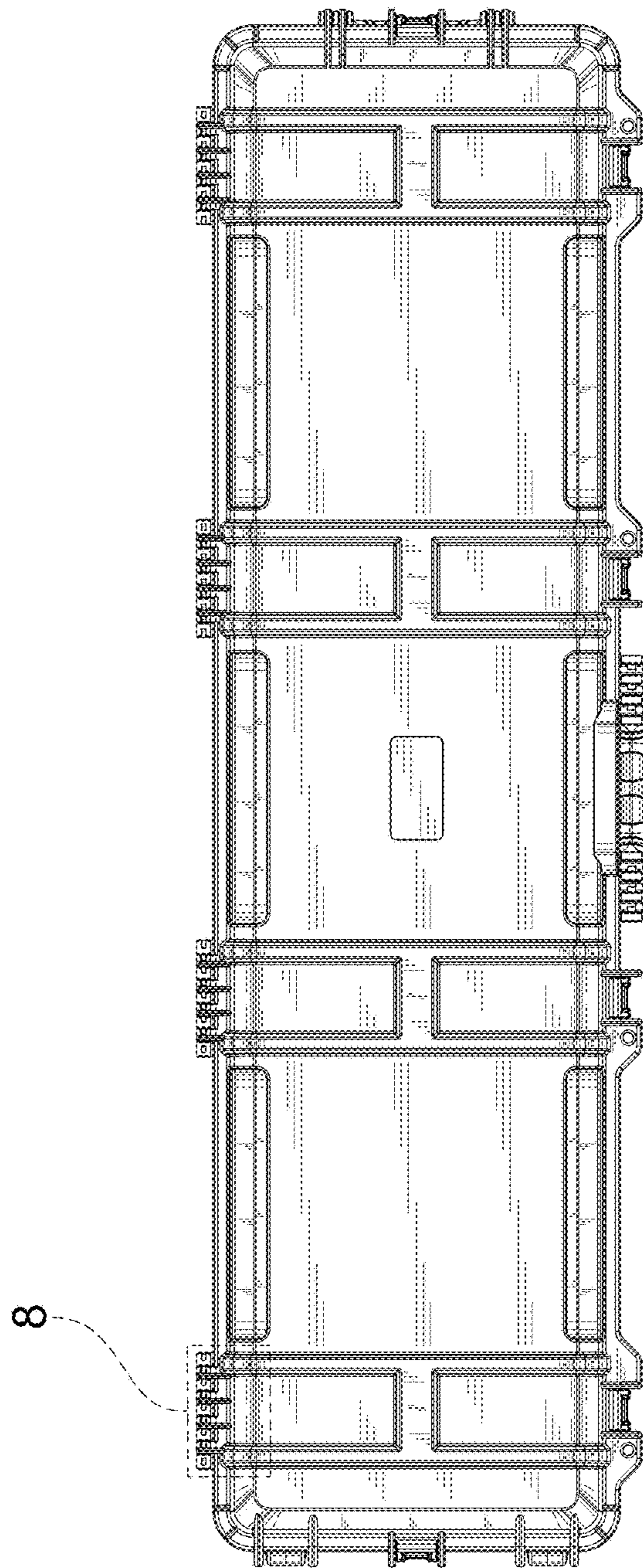

Fig. 3

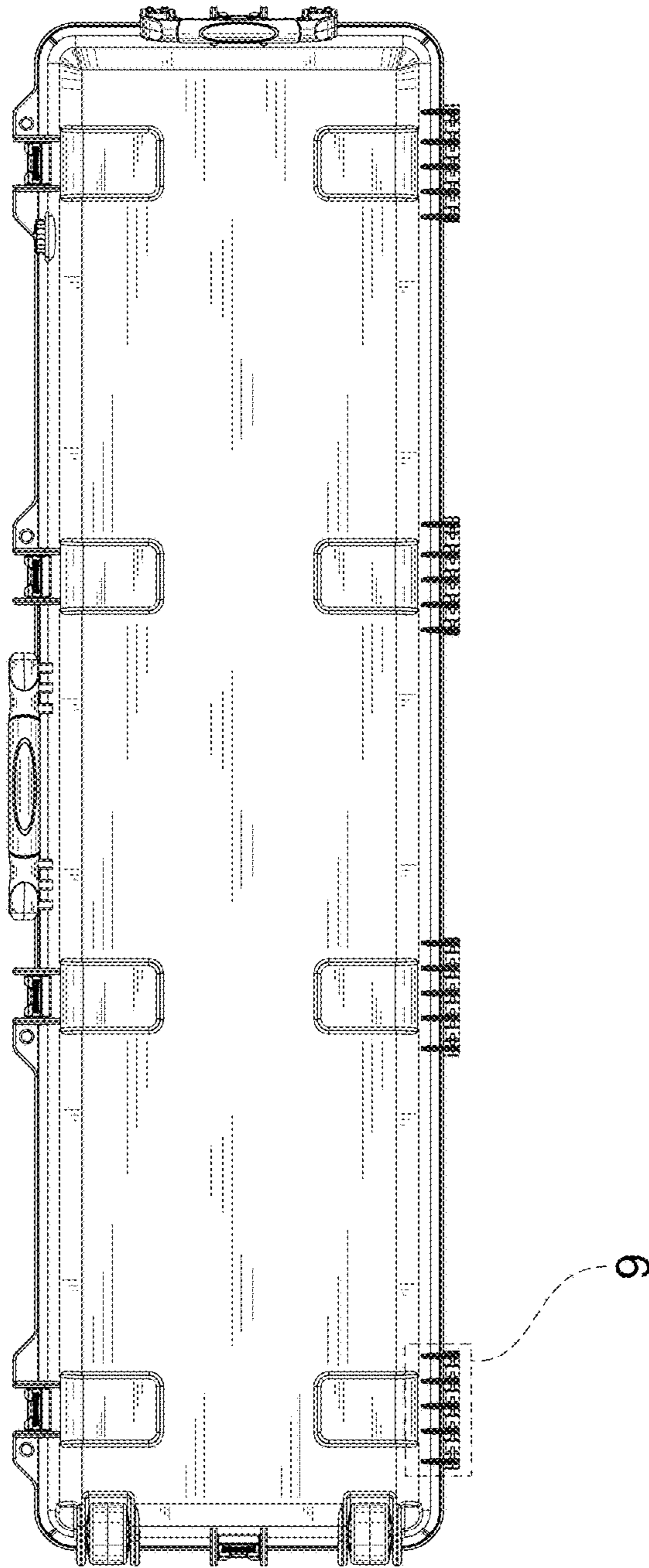

Fig. 4

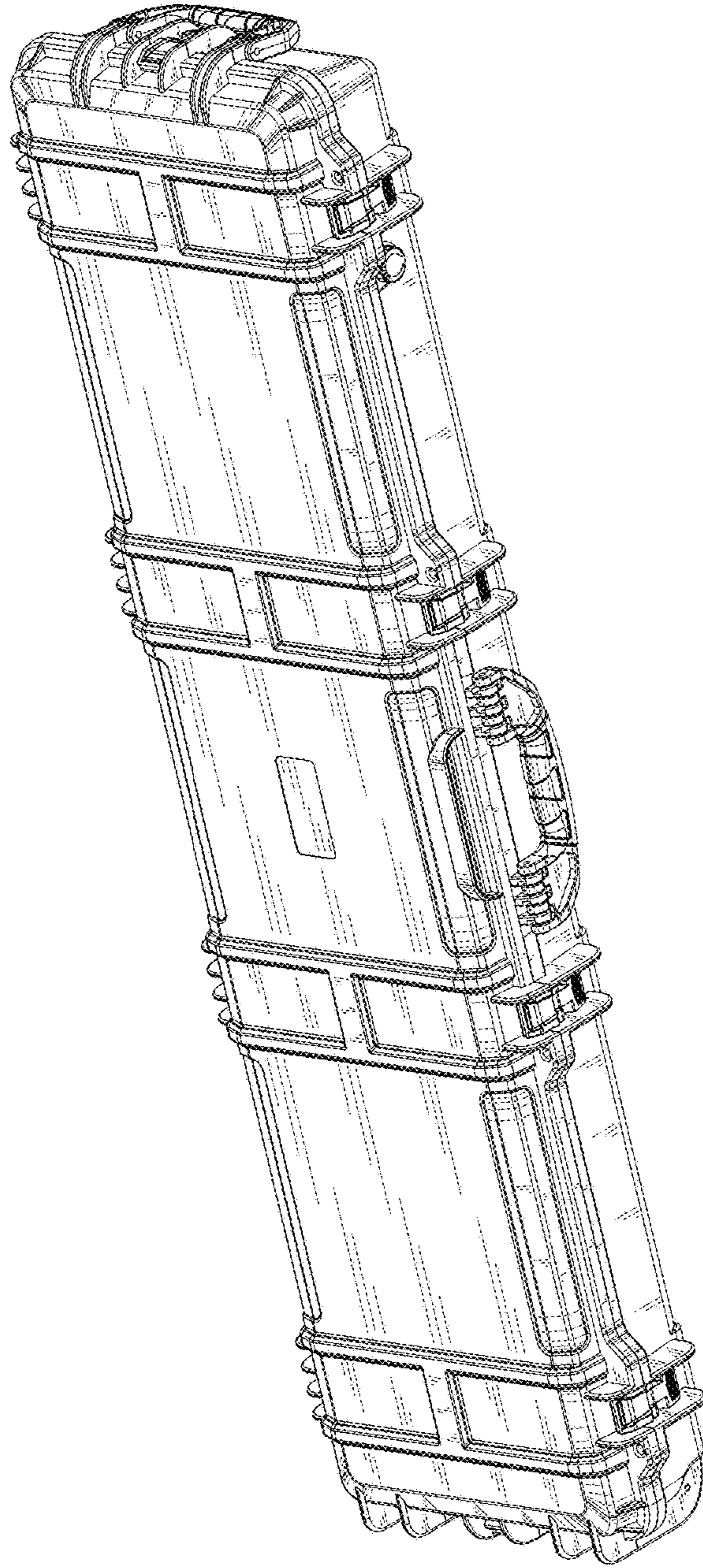

Fig. 5

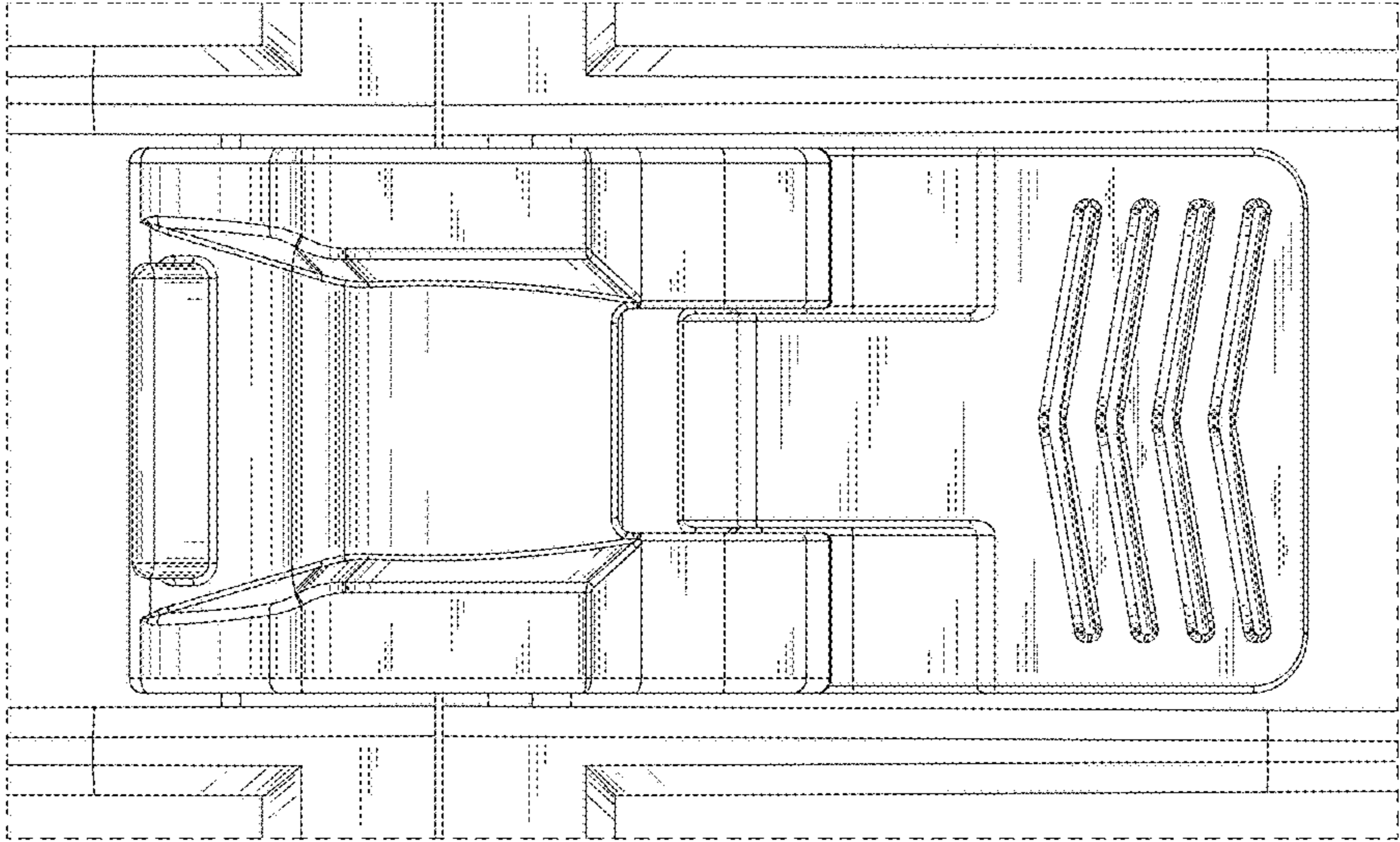

Fig. 6

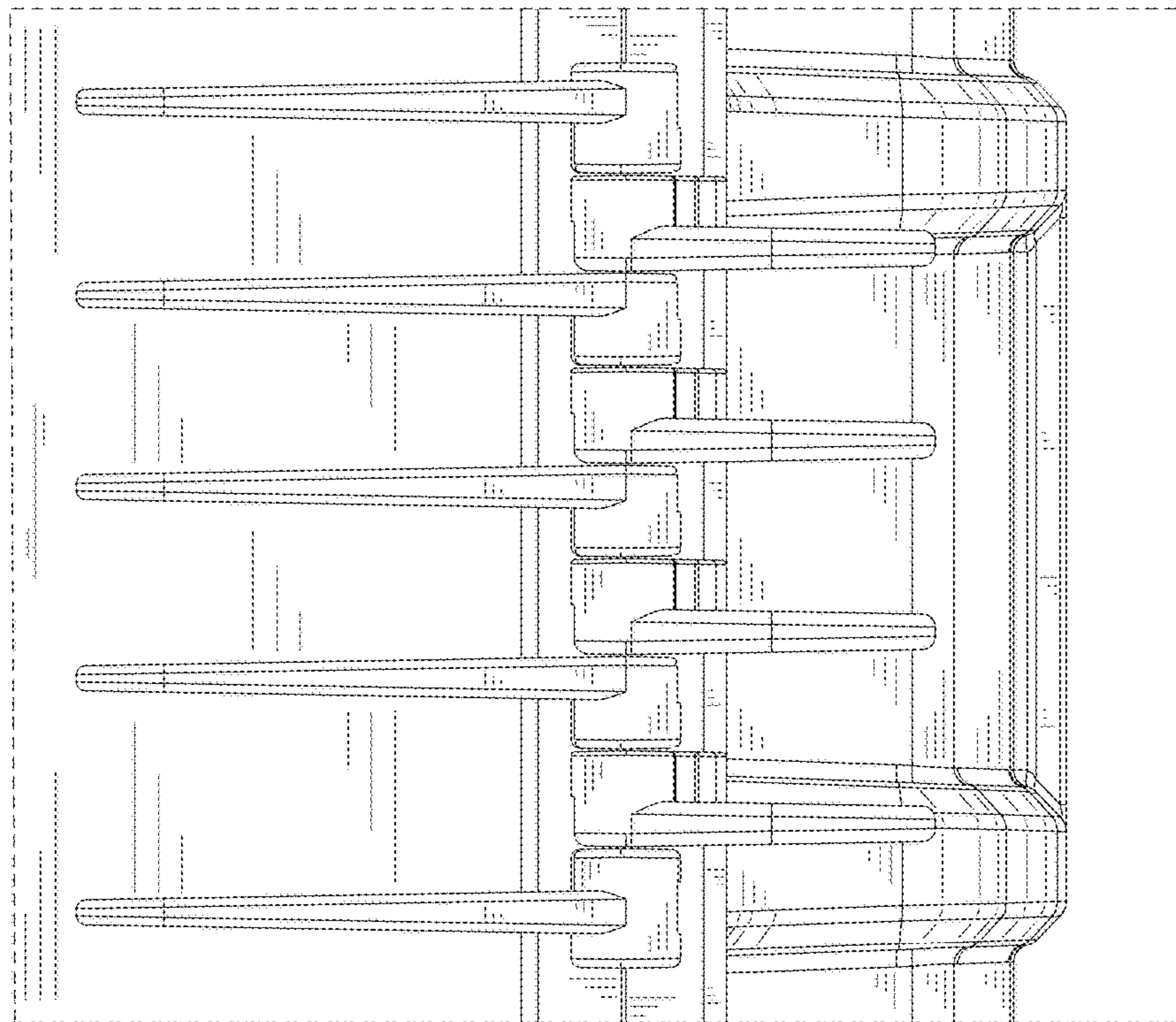

Fig. 7

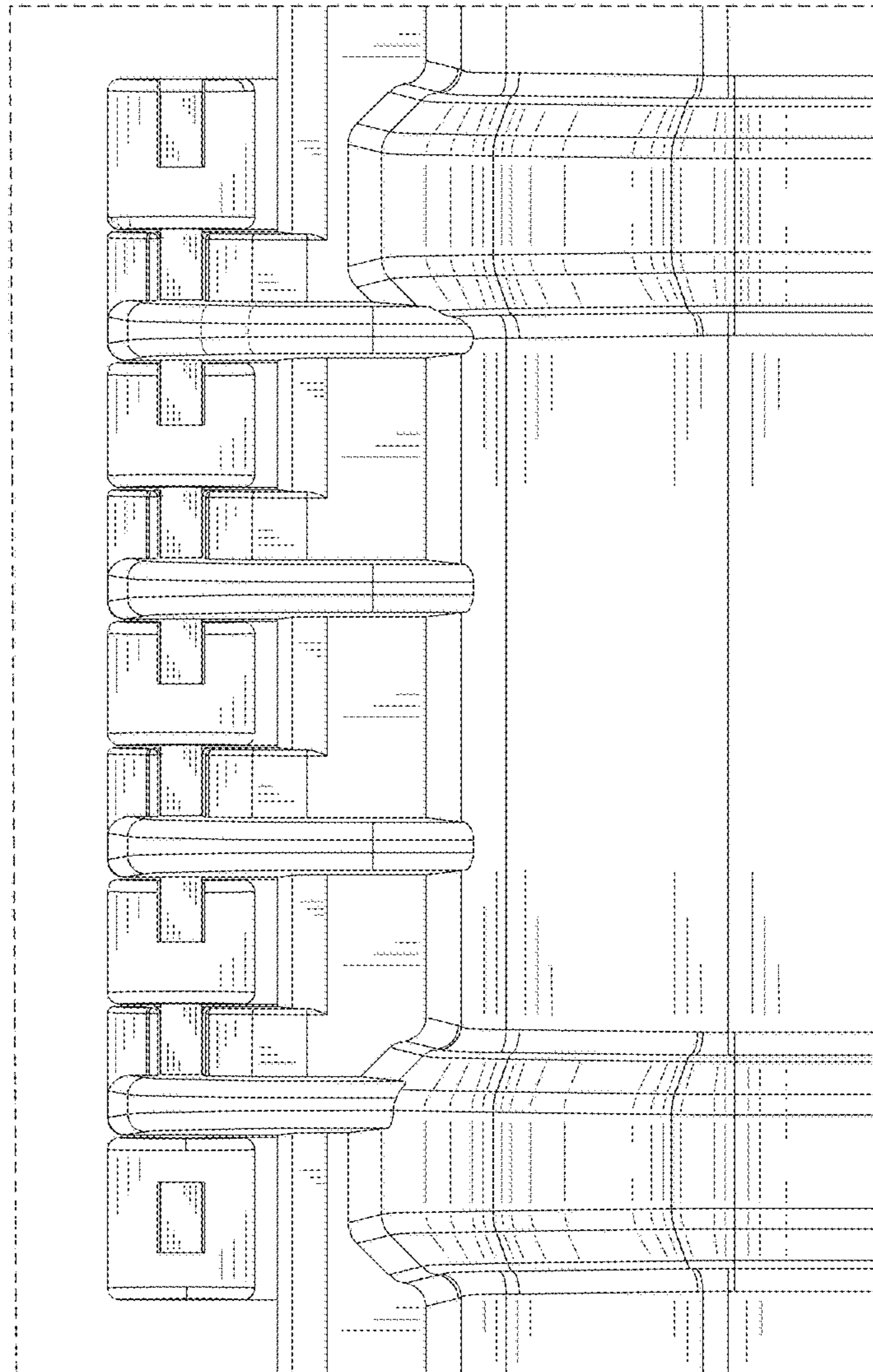

Fig. 8

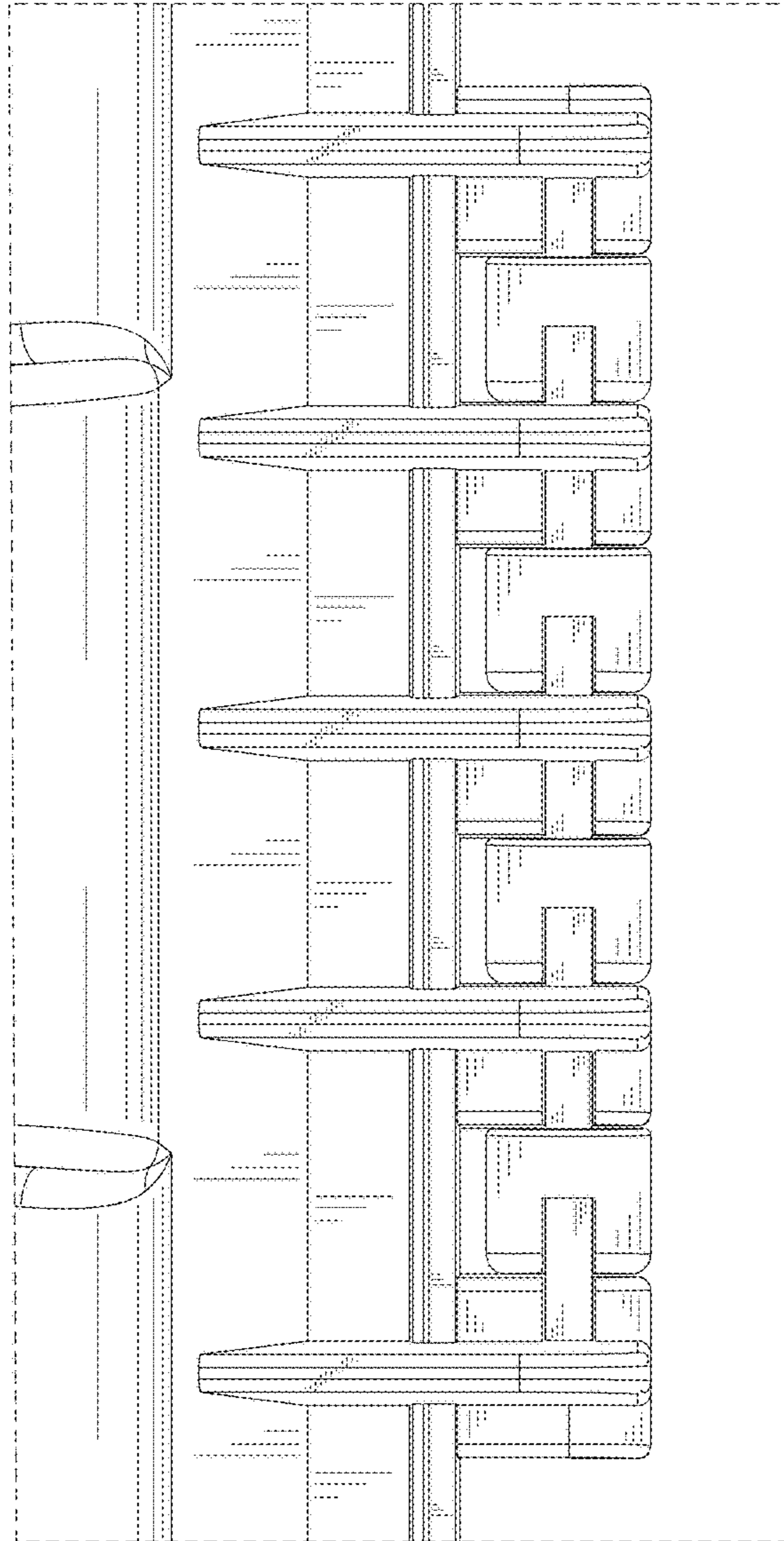

Fig. 9

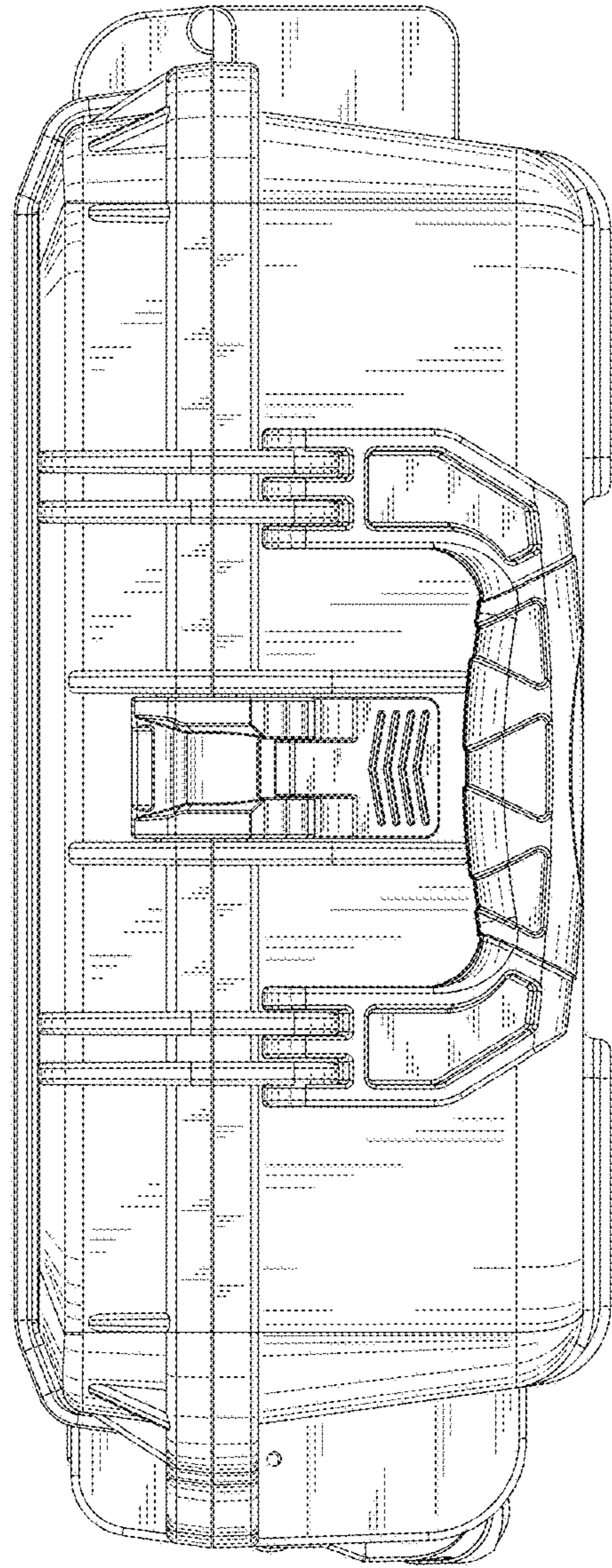

Fig. 10

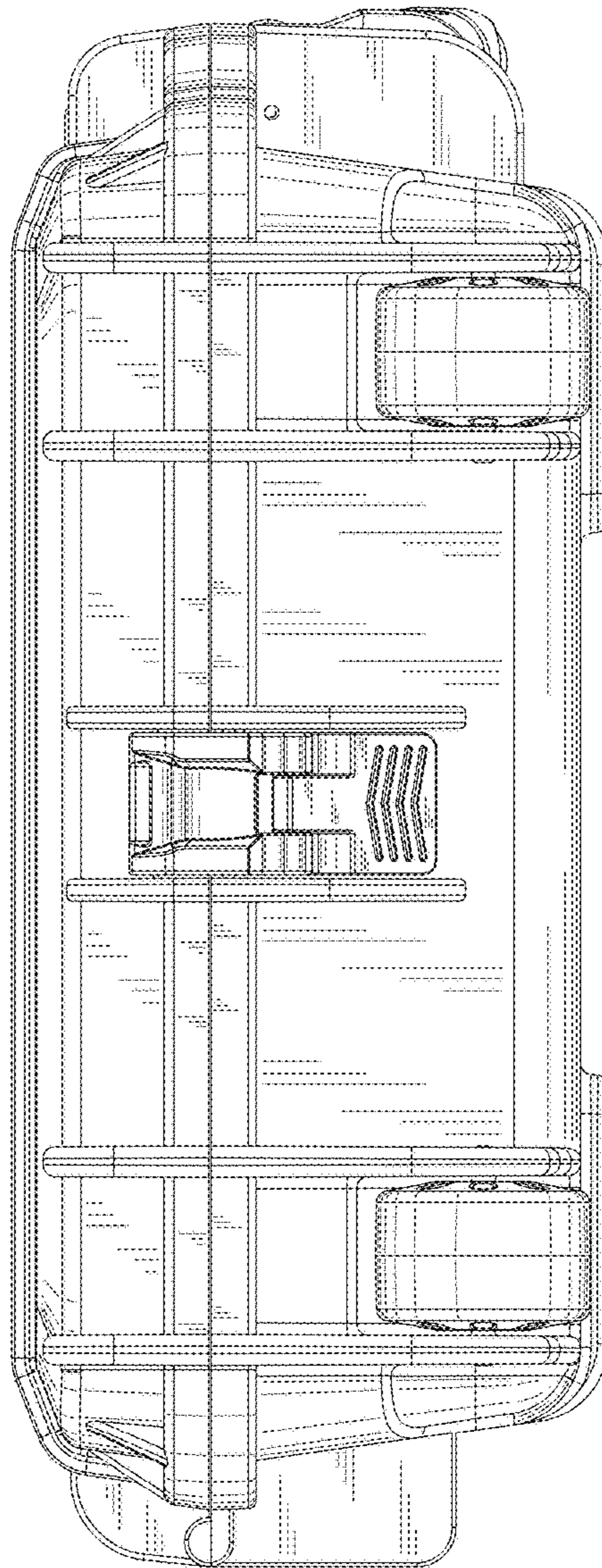

Fig. 11