



US00D861335S

(12) **United States Design Patent** (10) **Patent No.:** **US D861,335 S**  
**Barlier** (45) **Date of Patent:** **\*\* Oct. 1, 2019**

(54) **BAG**  
(71) Applicant: **KeepCool USA LLC**, Lafayette, CA (US)  
(72) Inventor: **Pierre Barlier**, Lafayette, CA (US)  
(73) Assignee: **KEEPCOOL USA LLC**, Lafayette, CA (US)  
(\*\*) Term: **15 Years**  
(21) Appl. No.: **29/615,871**  
(22) Filed: **Aug. 31, 2017**  
(51) **LOC (12) Cl.** ..... **03-01**  
(52) **U.S. Cl.**  
USPC ..... **D3/232; D7/607**  
(58) **Field of Classification Search**  
USPC ..... D3/201, 205, 226, 247, 250, 273, 274,  
D3/276, 278, 283, 284, 285, 289, 290,  
D3/299, 301, 905, 243; D7/605, 607  
(Continued)

(56) **References Cited**  
**U.S. PATENT DOCUMENTS**  
D282,602 S \* 2/1986 Allen ..... D3/287  
4,598,746 A \* 7/1986 Rabinowitz ..... A45C 11/20  
206/545  
(Continued)

**OTHER PUBLICATIONS**  
Amazon, "Earthwise Large Insulated Collapsible Reusable Box . . .", first on sale Apr. 18, 2016. (<https://www.amazon.com/Earthwise-Insulated-Collapsible-Reusable-Shopping/dp/B01EGKLVY/>) (Year: 2016).\*  
(Continued)

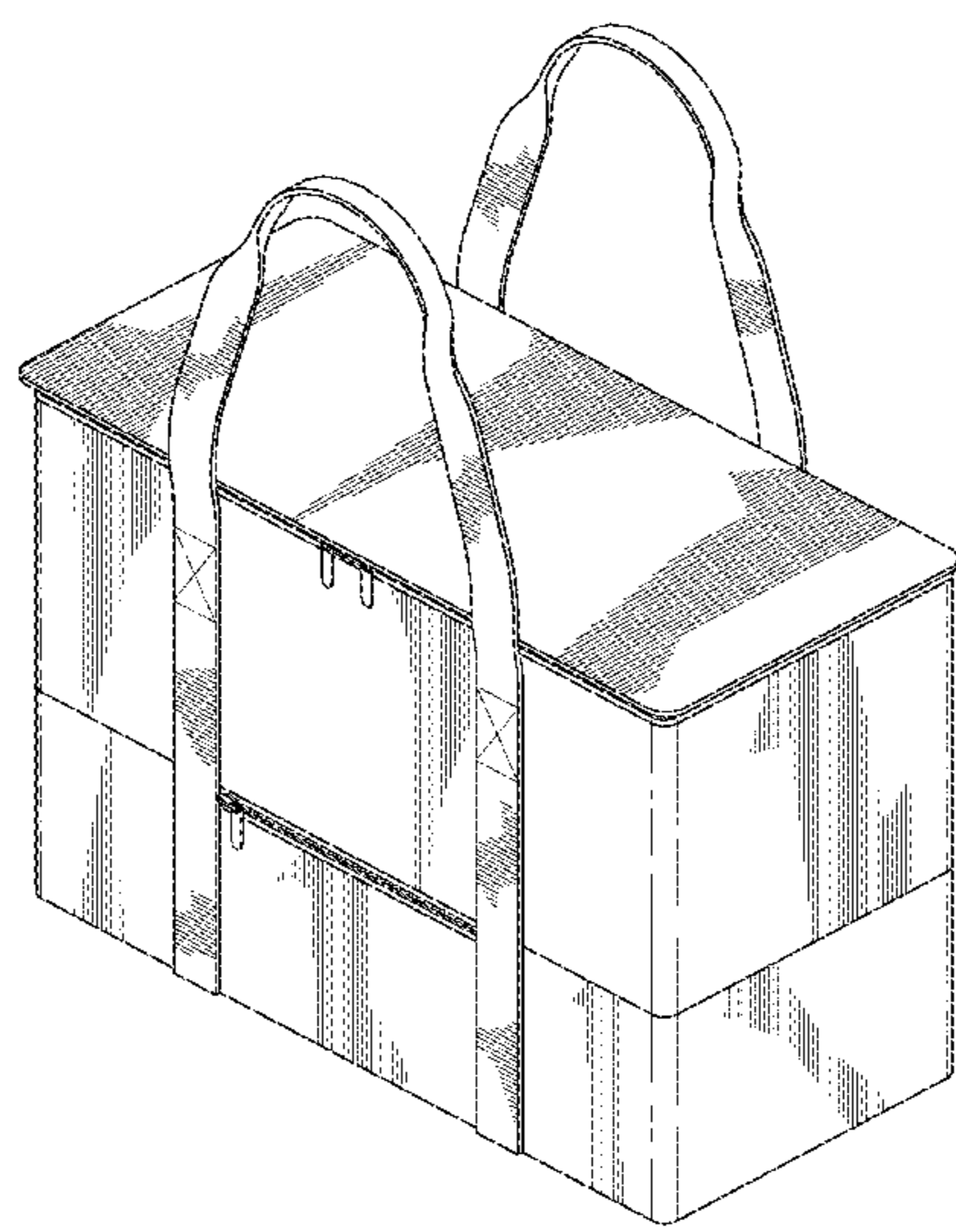
*Primary Examiner* — Jennifer Rivard  
*Assistant Examiner* — April Rivas

(74) *Attorney, Agent, or Firm* — Buchalter; Kari L. Barnes

(57) **CLAIM**  
The ornamental design for a bag, as shown and described.

**DESCRIPTION**  
FIG. 1 is a Top, Left and Front perspective view of a bag showing my new design;  
FIG. 2 is a Front side view of the bag illustrated in FIG. 1;  
FIG. 3 is a Rear side view of the bag illustrated in FIG. 1;  
FIG. 4 is a Top plan view of the bag illustrated in FIG. 1;  
FIG. 5 is a Bottom plan view of the bag illustrated in FIG. 1;  
FIG. 6 is a Left side view of the bag illustrated in FIG. 1; and  
FIG. 7 is a Right side view of the bag illustrated in FIG. 1.  
FIG. 8 is a Top, Left and Front perspective view of a second embodiment of the bag;  
FIG. 9 is a Front side view of the bag illustrated in FIG. 8;  
FIG. 10 is a Rear side view of the bag illustrated in FIG. 8;  
FIG. 11 is a Top plan view of the bag illustrated in FIG. 8;  
FIG. 12 is a Bottom plan view of the bag illustrated in FIG. 8;  
FIG. 13 is a Left side view of the bag illustrated in FIG. 8; and  
FIG. 14 is a Right side view of the bag illustrated in FIG. 8.  
FIG. 15 is a Top, Left and Front perspective view of a third embodiment of the bag;  
FIG. 16 is a Front side view of the bag illustrated in FIG. 16;  
FIG. 17 is a Rear side view of the bag illustrated in FIG. 16;  
FIG. 18 is a Top plan view of the bag illustrated in FIG. 16;  
FIG. 19 is a Bottom plan view of the bag illustrated in FIG. 16;  
FIG. 20 is a Left side view of the bag illustrated in FIG. 16; and  
FIG. 21 is a Right side view of the bag illustrated in FIG. 16.  
The broken lines shown in the drawings are included for the purpose of illustrating portions of the bag and form no part of the claimed design.

**1 Claim, 18 Drawing Sheets**



(58) **Field of Classification Search**  
 CPC ..... A45C 3/00; A45C 3/004; A45C 2003/008;  
 A45C 5/06; A45C 3/04; A45C 13/00  
 See application file for complete search history.

(56) **References Cited**

U.S. PATENT DOCUMENTS

D340,621	S *	10/1993	Melk	.....	D3/287
D371,051	S *	6/1996	Melk	.....	D7/607
5,918,711	A *	7/1999	Godshaw	.....	A45C 13/02
					190/107
D481,539	S *	11/2003	Martz	.....	D3/279
D587,010	S *	2/2009	Deck	.....	D3/246
D596,396	S *	7/2009	McCoy	.....	D3/232
D630,013	S *	1/2011	Yu	.....	D3/232
D630,844	S *	1/2011	Wang	.....	D3/232
D637,809	S *	5/2011	Meldeau	.....	D3/232
D641,162	S *	7/2011	Houston	.....	D3/283
D641,549	S *	7/2011	Caldwell	.....	D3/232

D717,040	S *	11/2014	Swartzel	.....	D3/232
D723,278	S *	3/2015	Van Migem	.....	D3/315
D761,561	S *	7/2016	Cheng	.....	D3/246
D763,570	S *	8/2016	Potts	.....	D3/232
D768,378	S *	10/2016	Schilp	.....	D3/232
9,578,937	B2 *	2/2017	Kern	.....	A45C 3/04
D783,371	S *	4/2017	Burton	.....	D3/290
D817,722	S *	5/2018	Bradley	.....	D7/607
D832,579	S *	11/2018	Monroe	.....	D3/307
2010/0014785	A1 *	1/2010	Deck	.....	A45C 3/04
					383/12

OTHER PUBLICATIONS

Amazon, "yodo 26L Collapsible Soft Sided Cooler Bag . . .", first reviewed Aug. 5, 2018. (<https://www.amazon.com/dp/B07DCNB63Q/>) (Year: 2018).\*

Amazon, "Bagmine 65 Cans Cooler Bag . . .", First reviewed Aug. 18, 2018. (<https://www.amazon.com/dp/B07FTBGJRR/>) (Year: 2018).\*

\* cited by examiner



FIG. 1

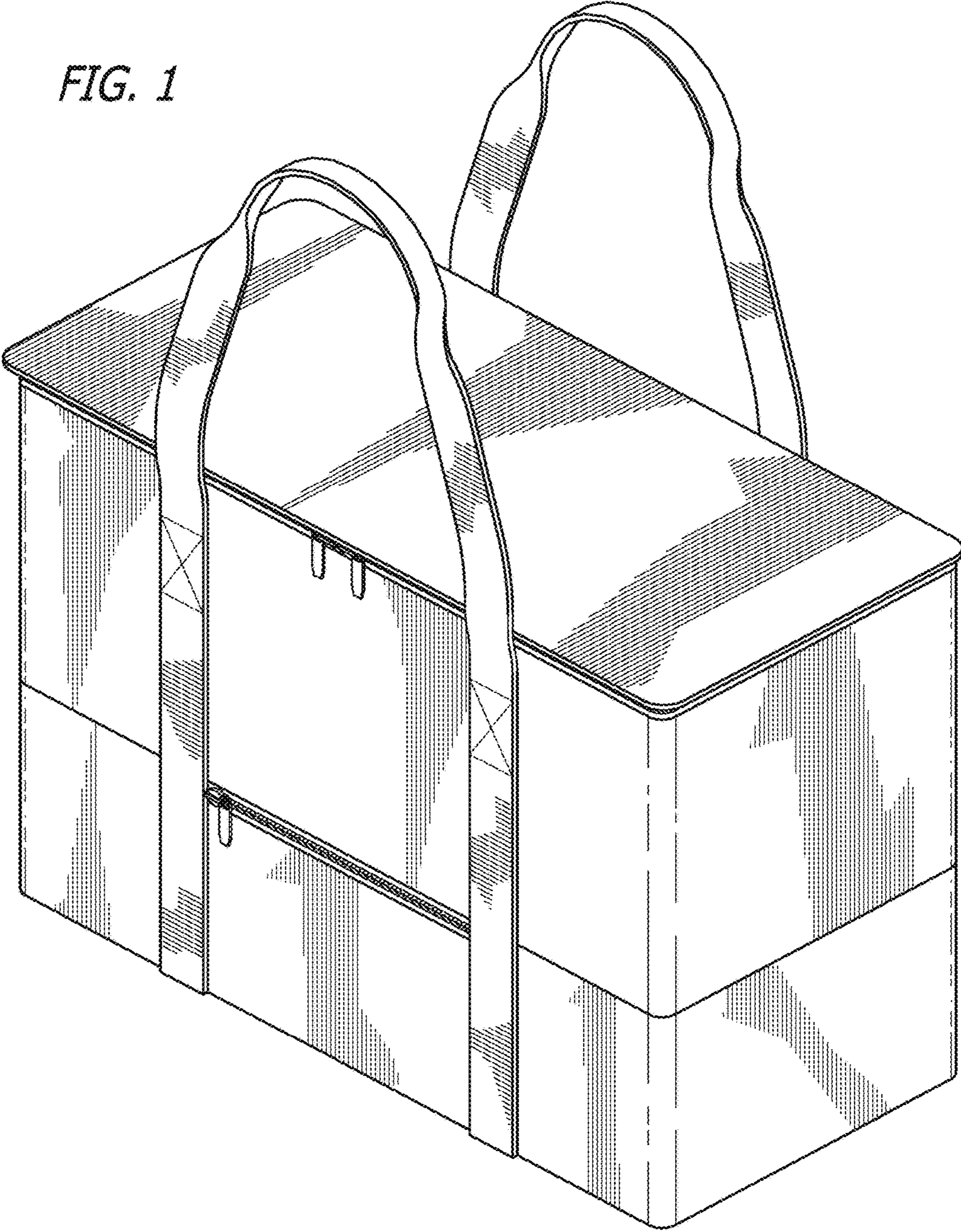
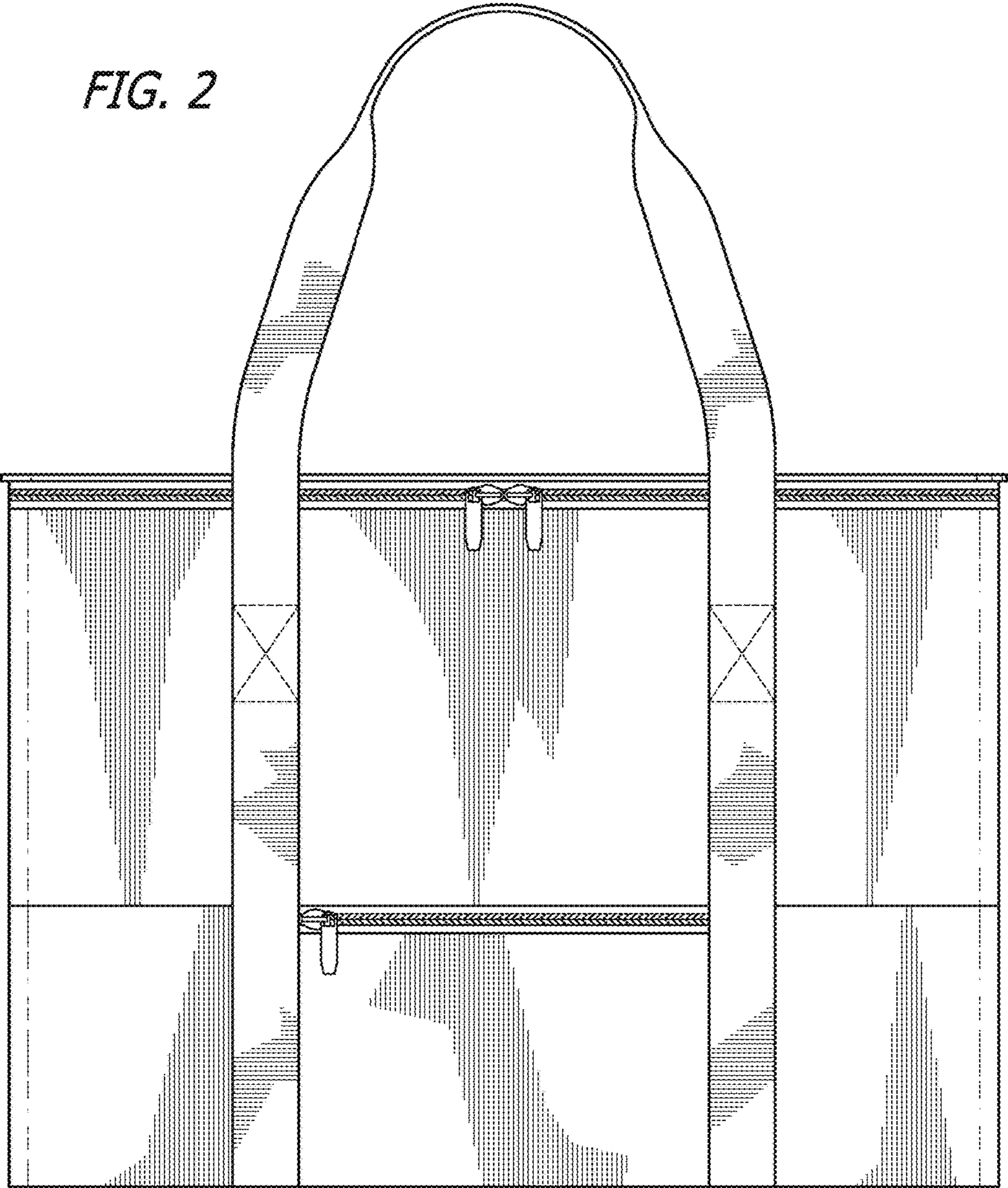
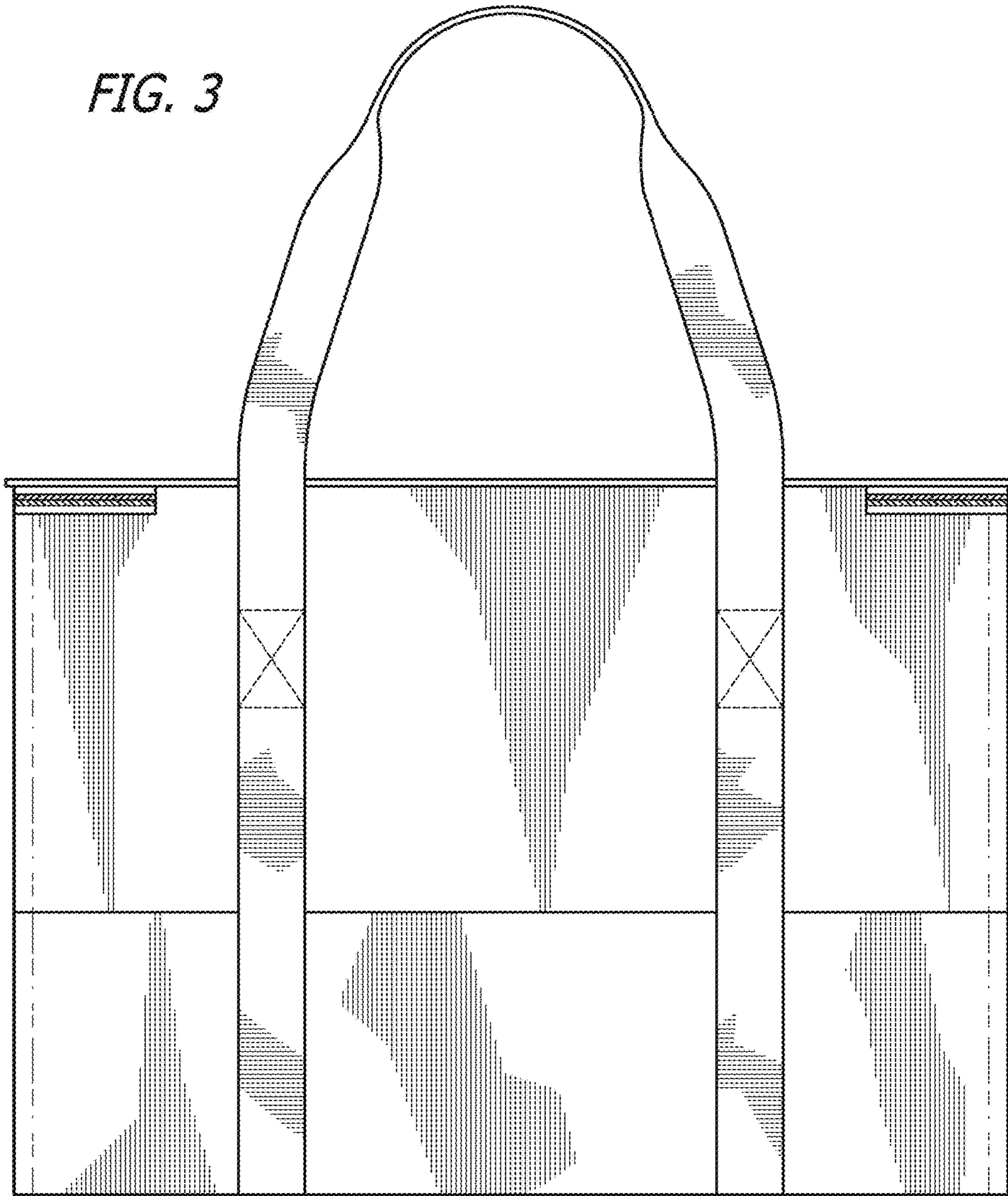


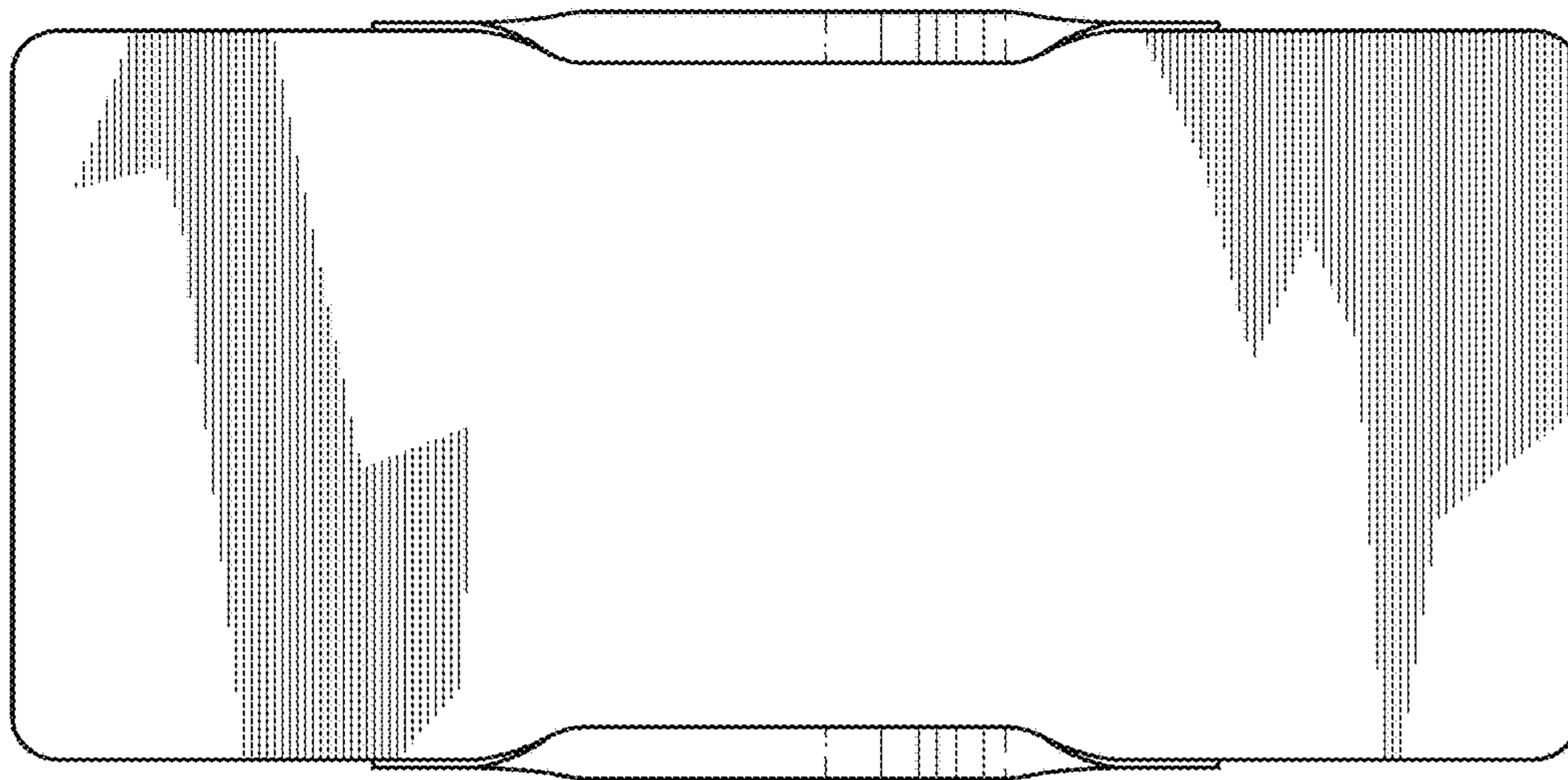
FIG. 2



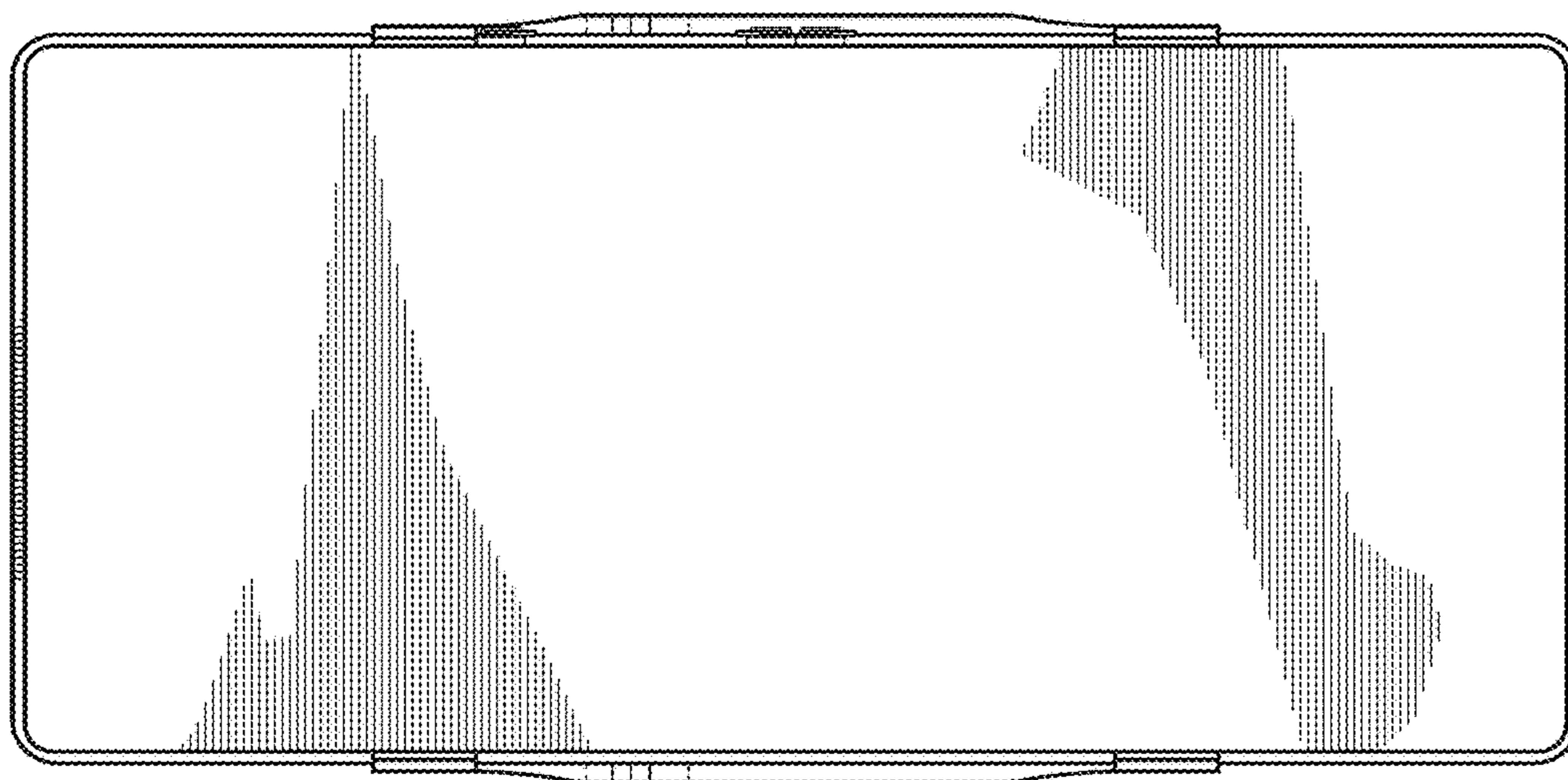


*FIG. 3*



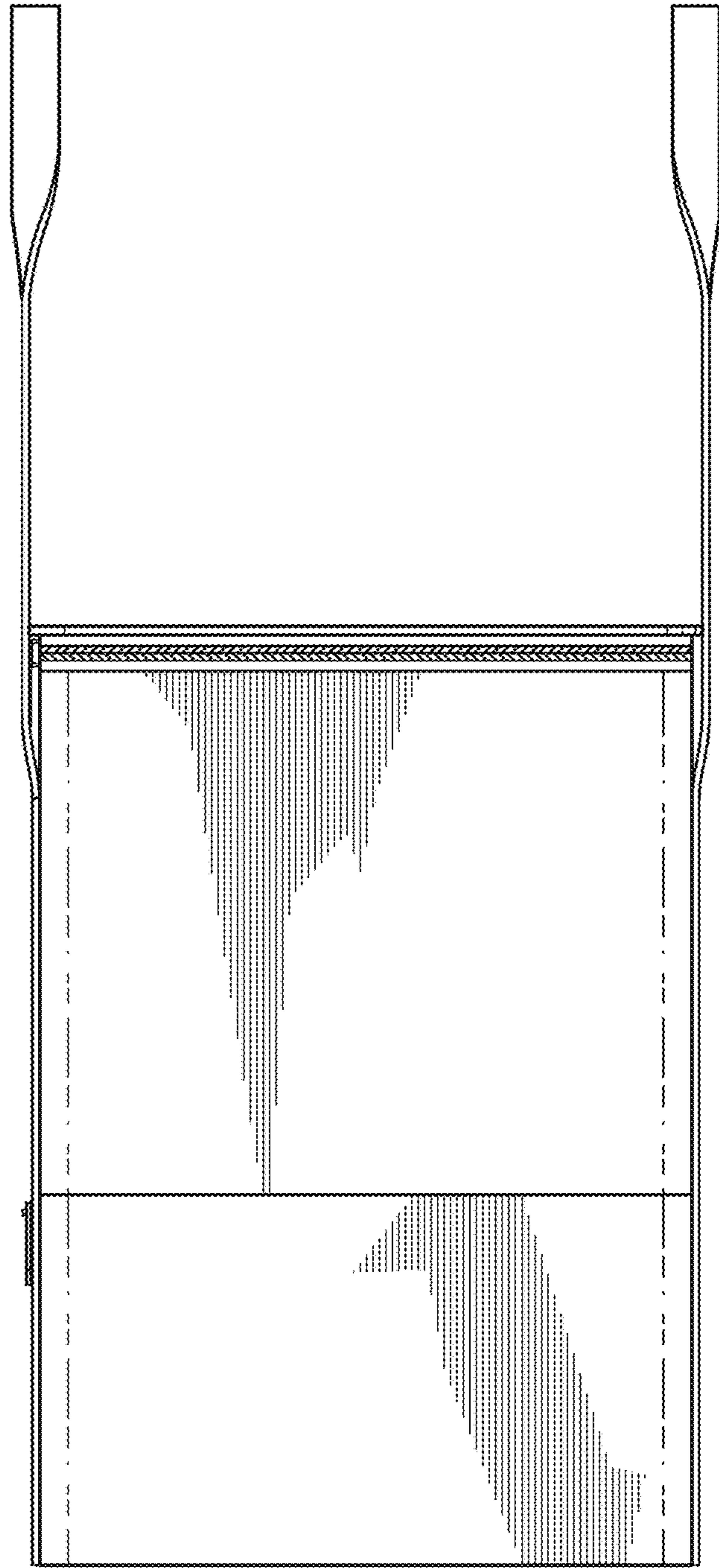


*FIG. 4*

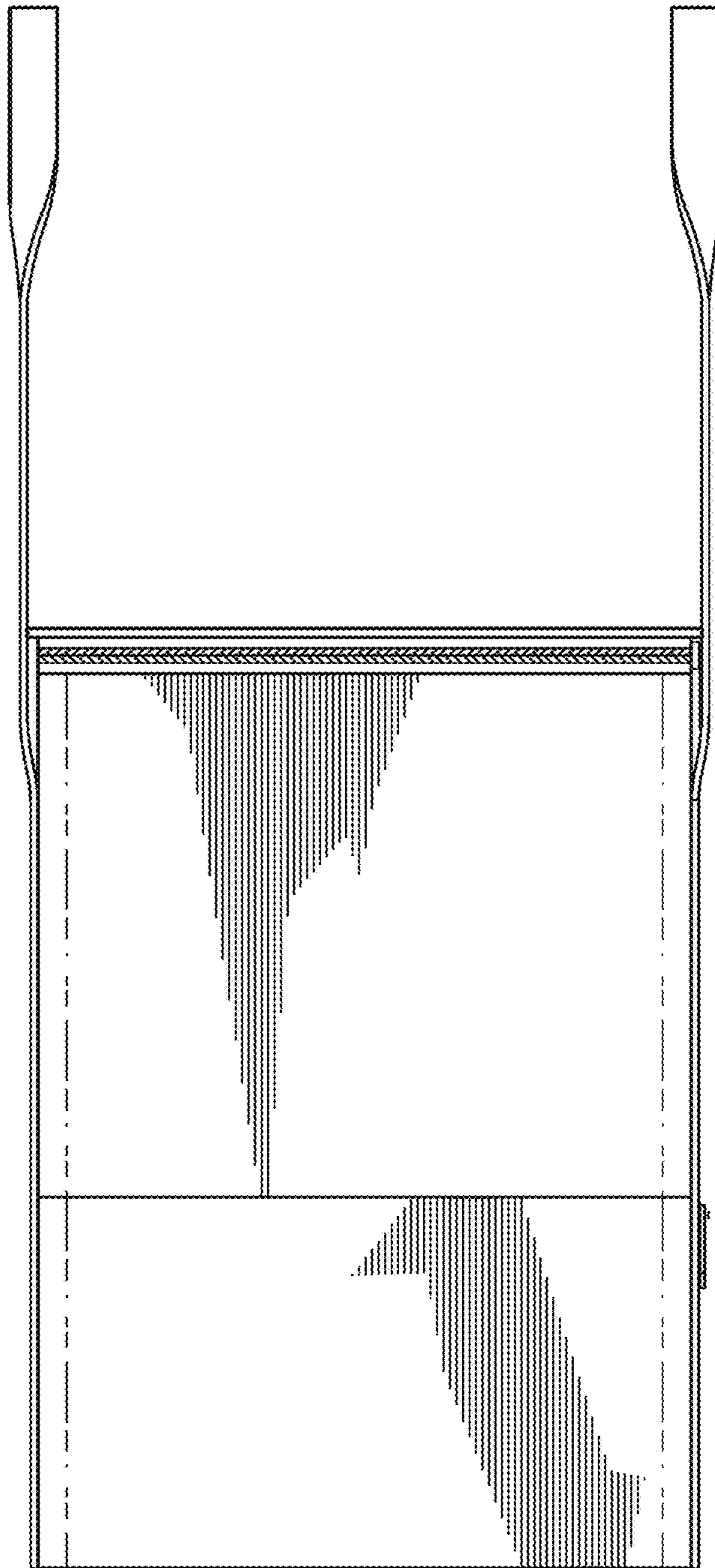


*FIG. 5*

*FIG. 6*



*FIG. 7*





*FIG. 8*

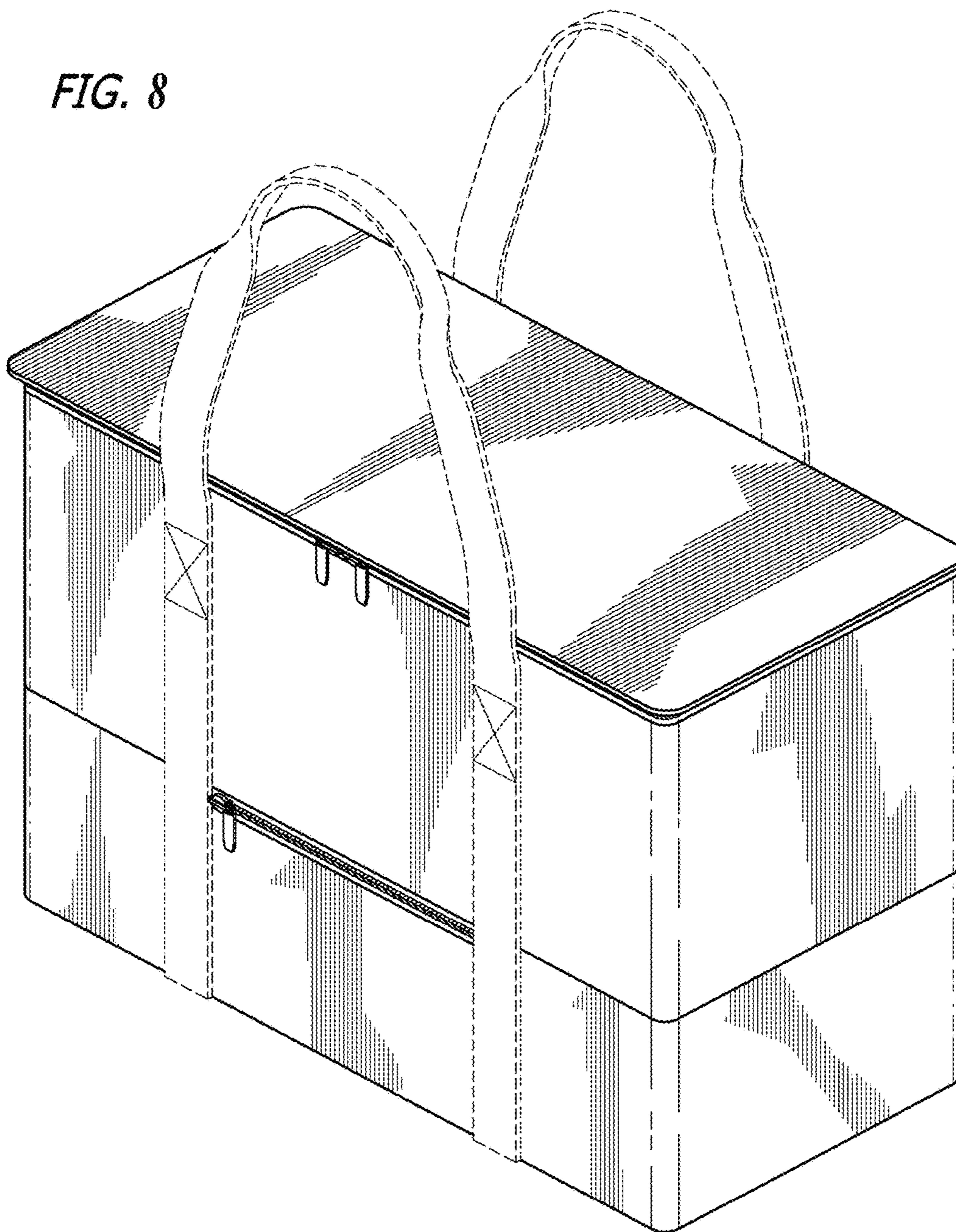


FIG. 9

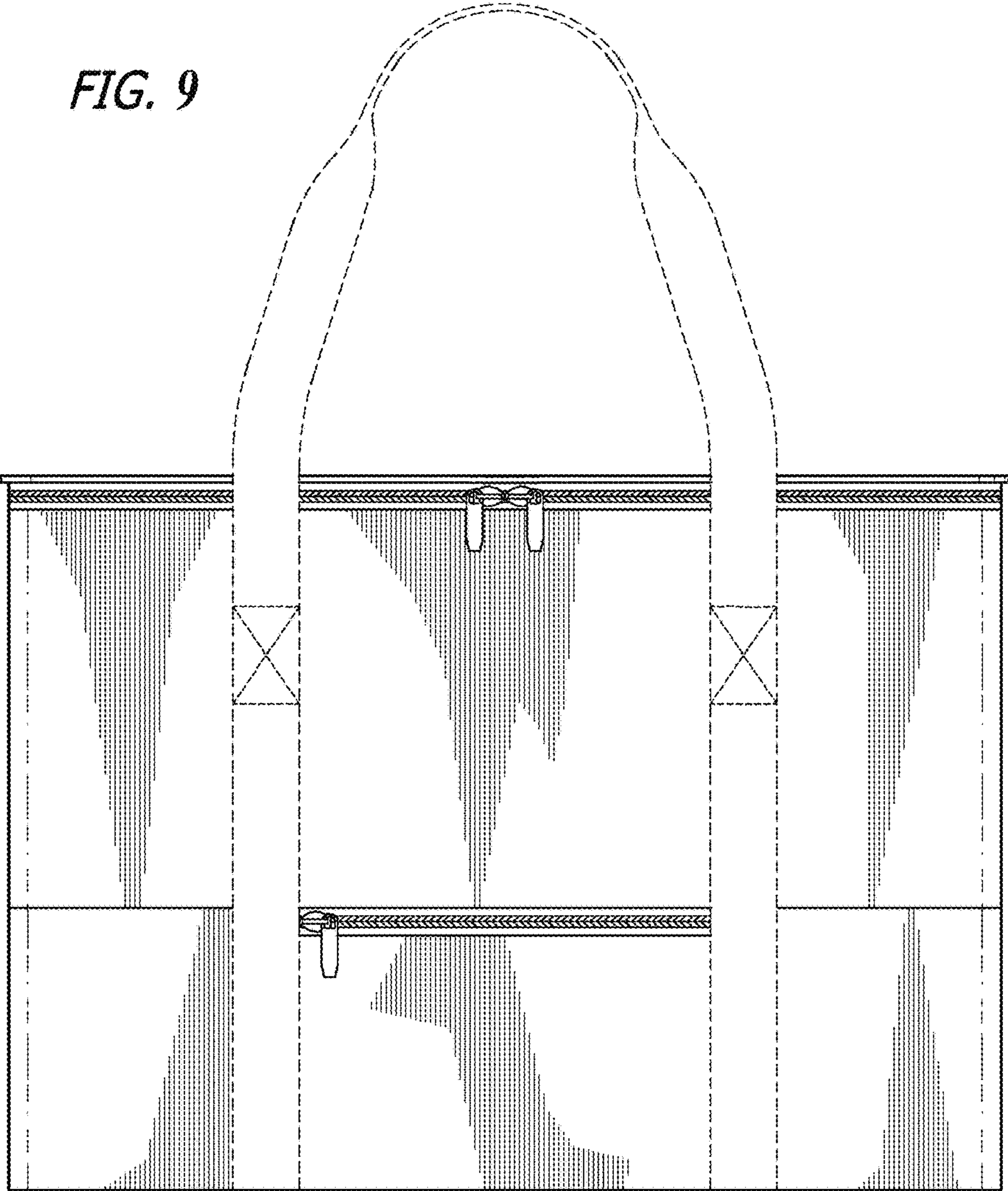
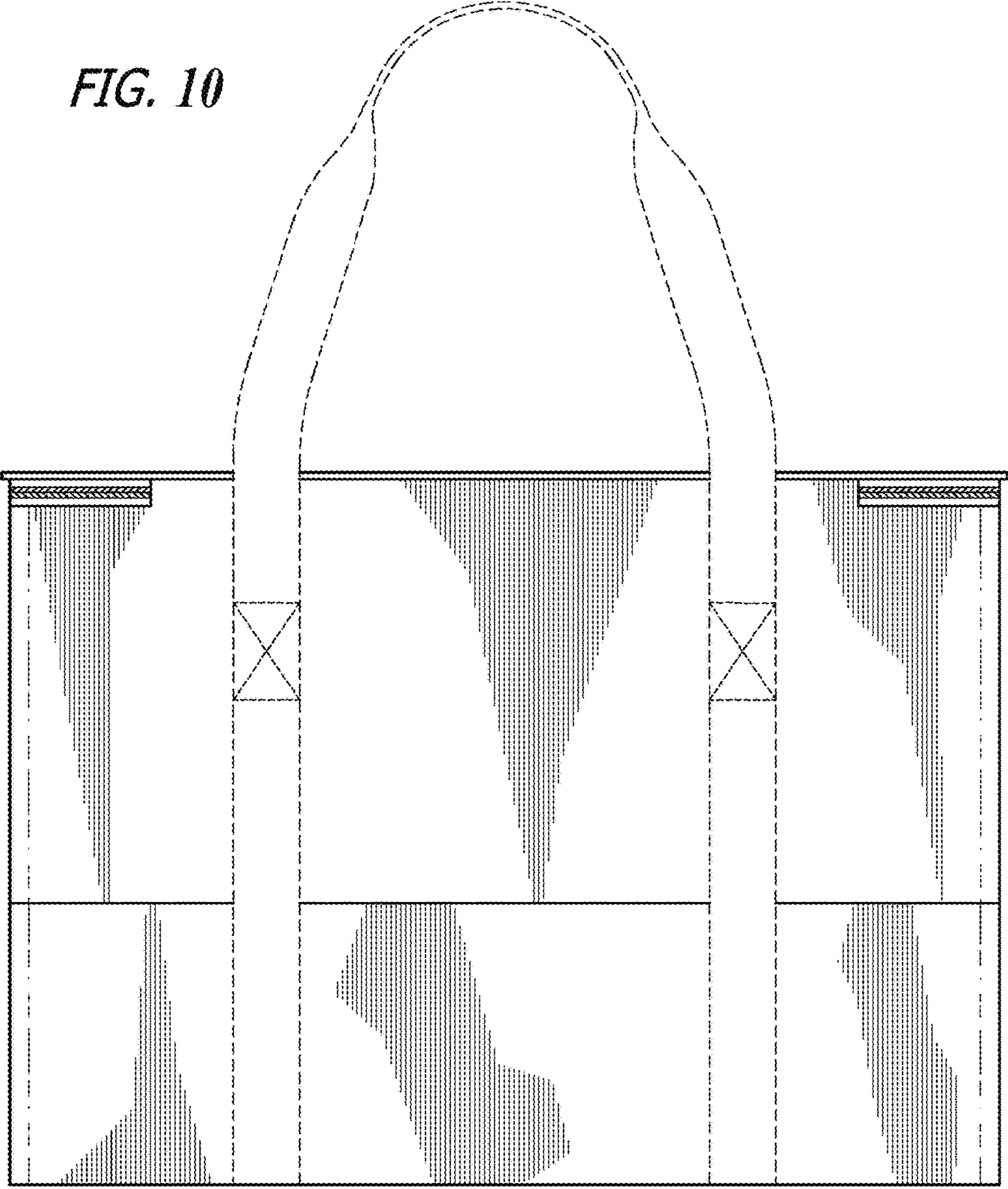
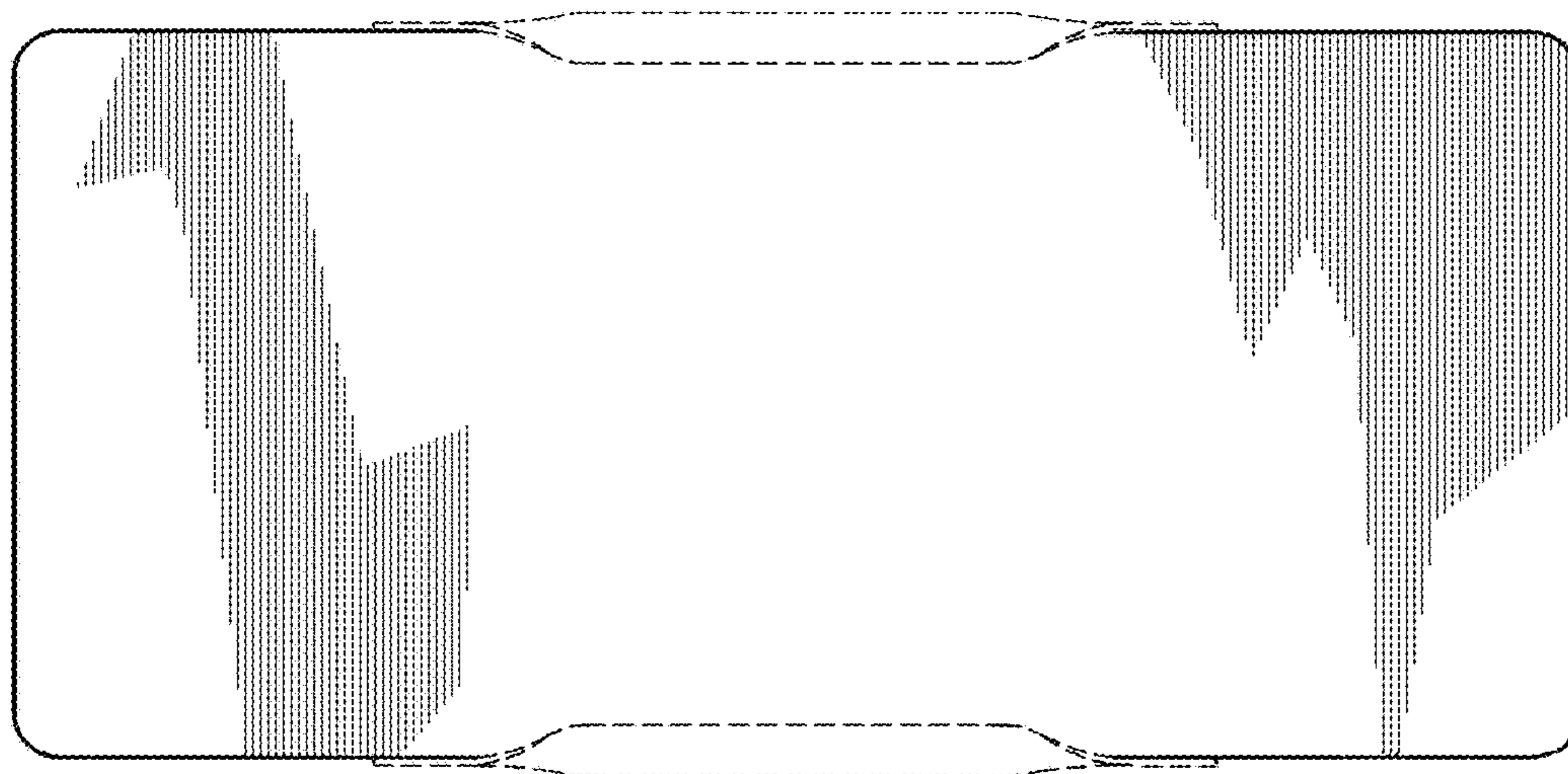


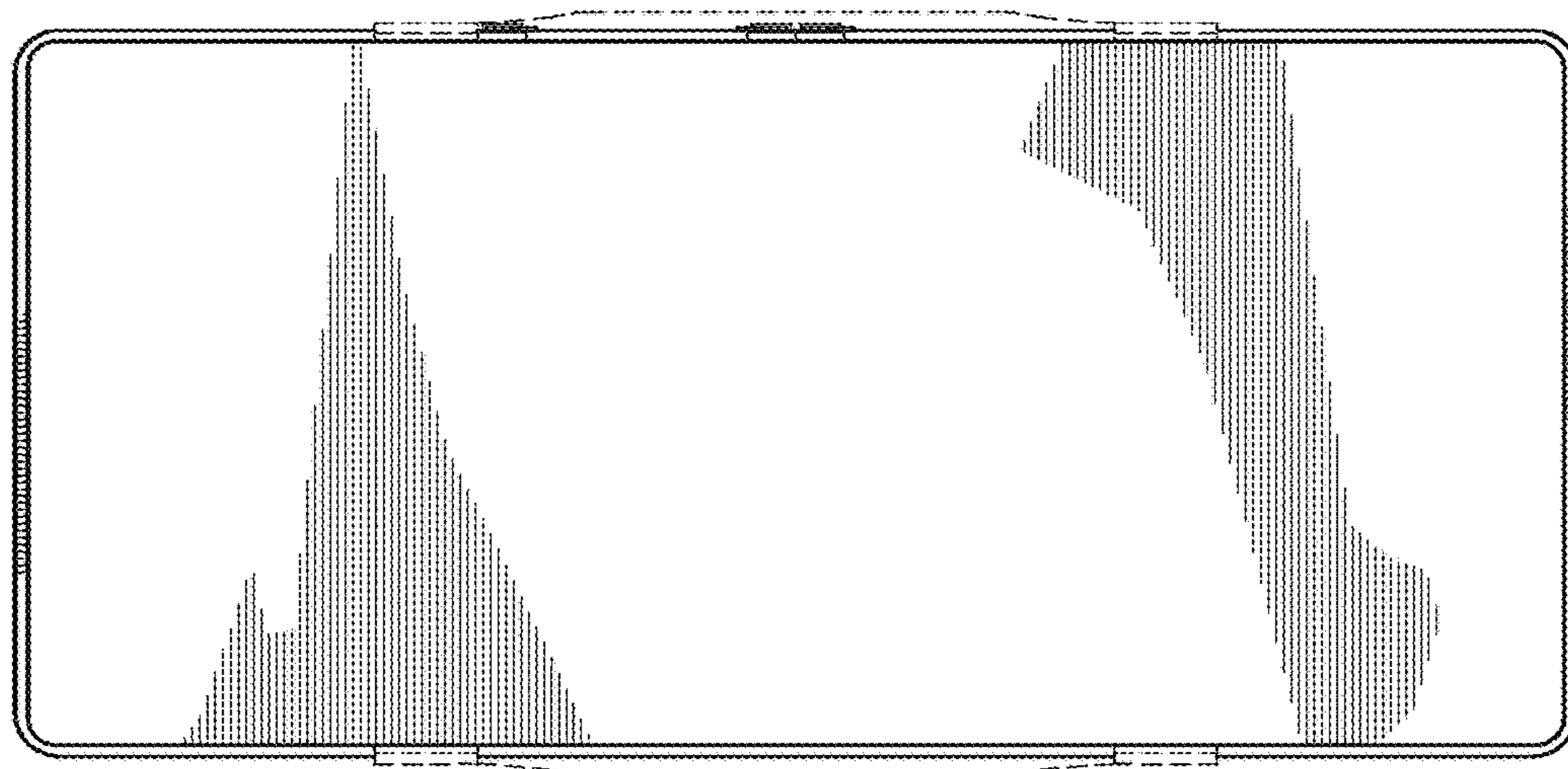
FIG. 10





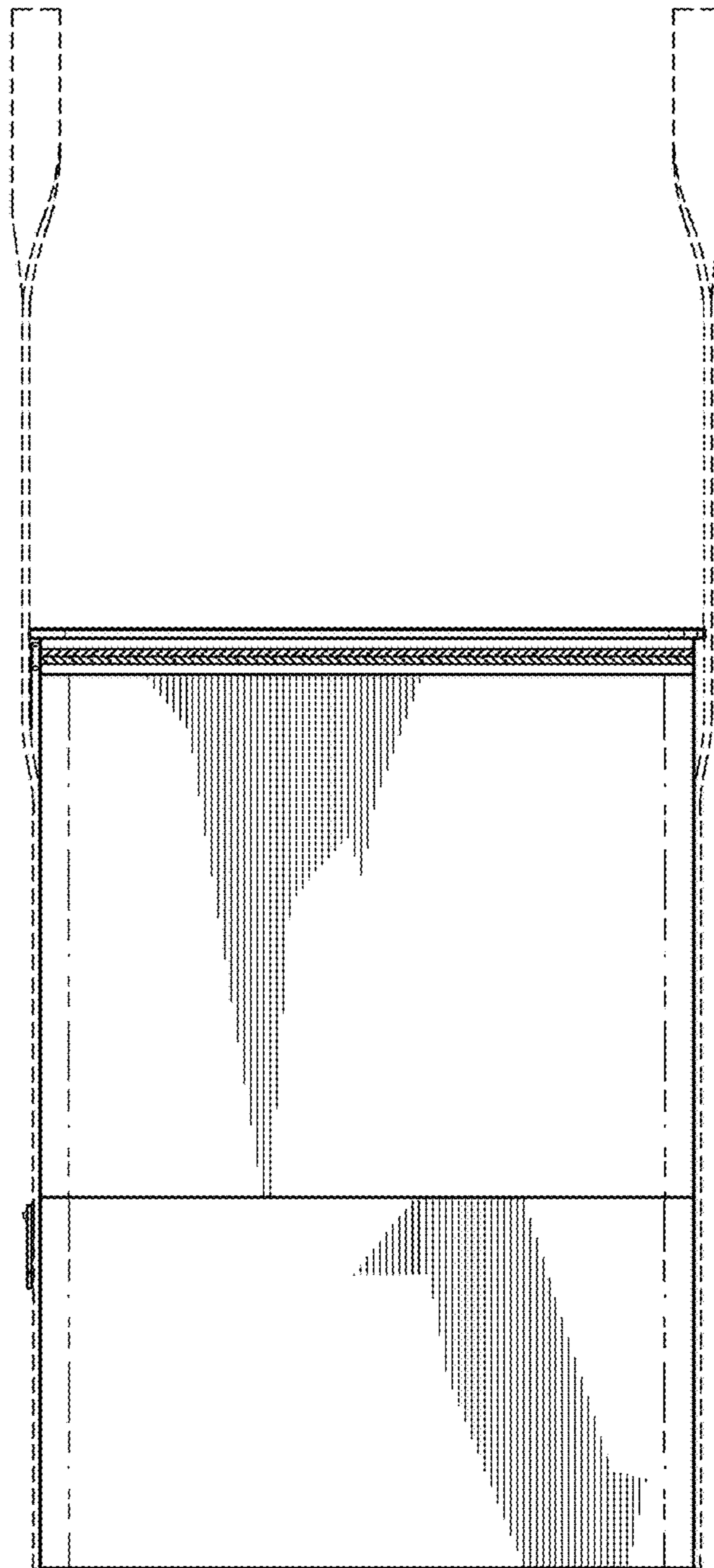


*FIG. 11*



*FIG. 12*

*FIG. 13*



*FIG. 14*

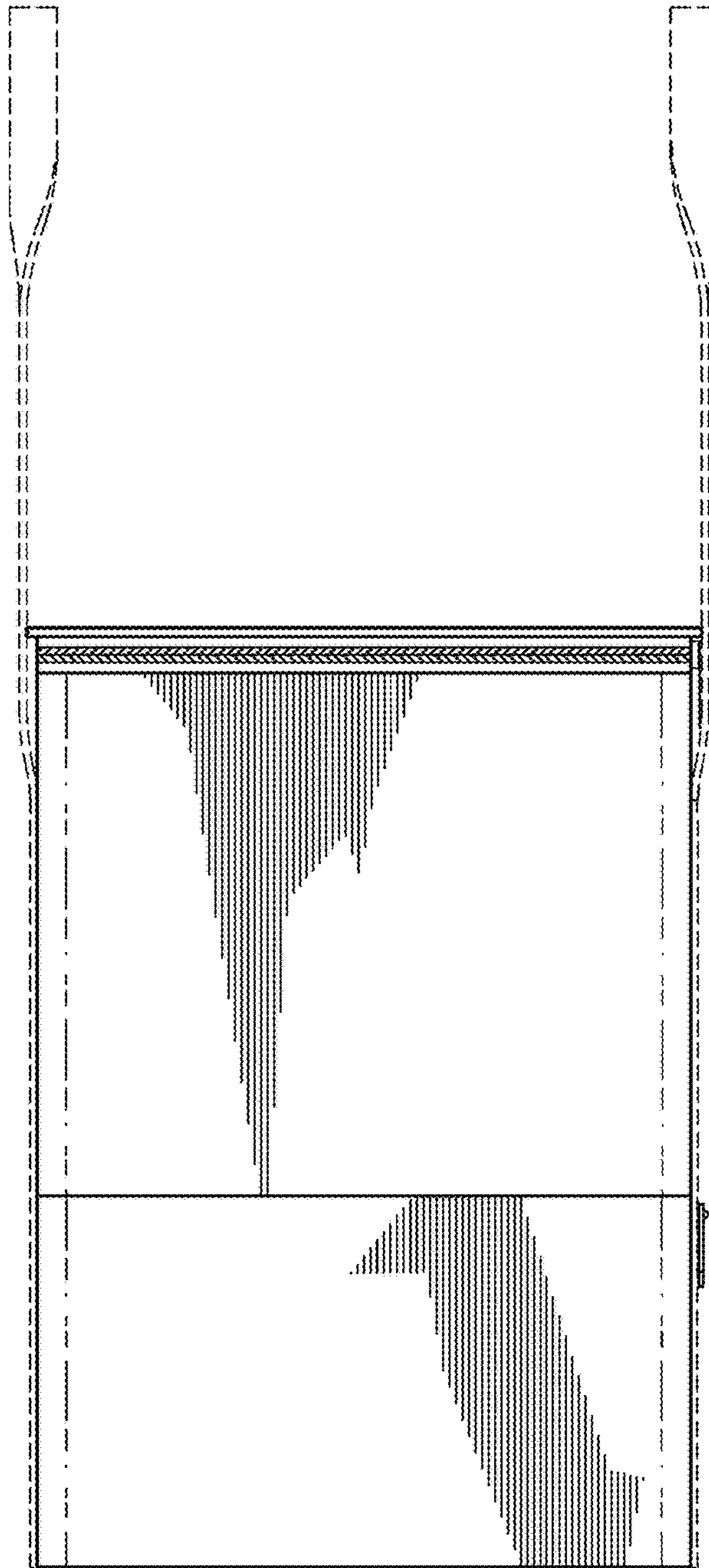
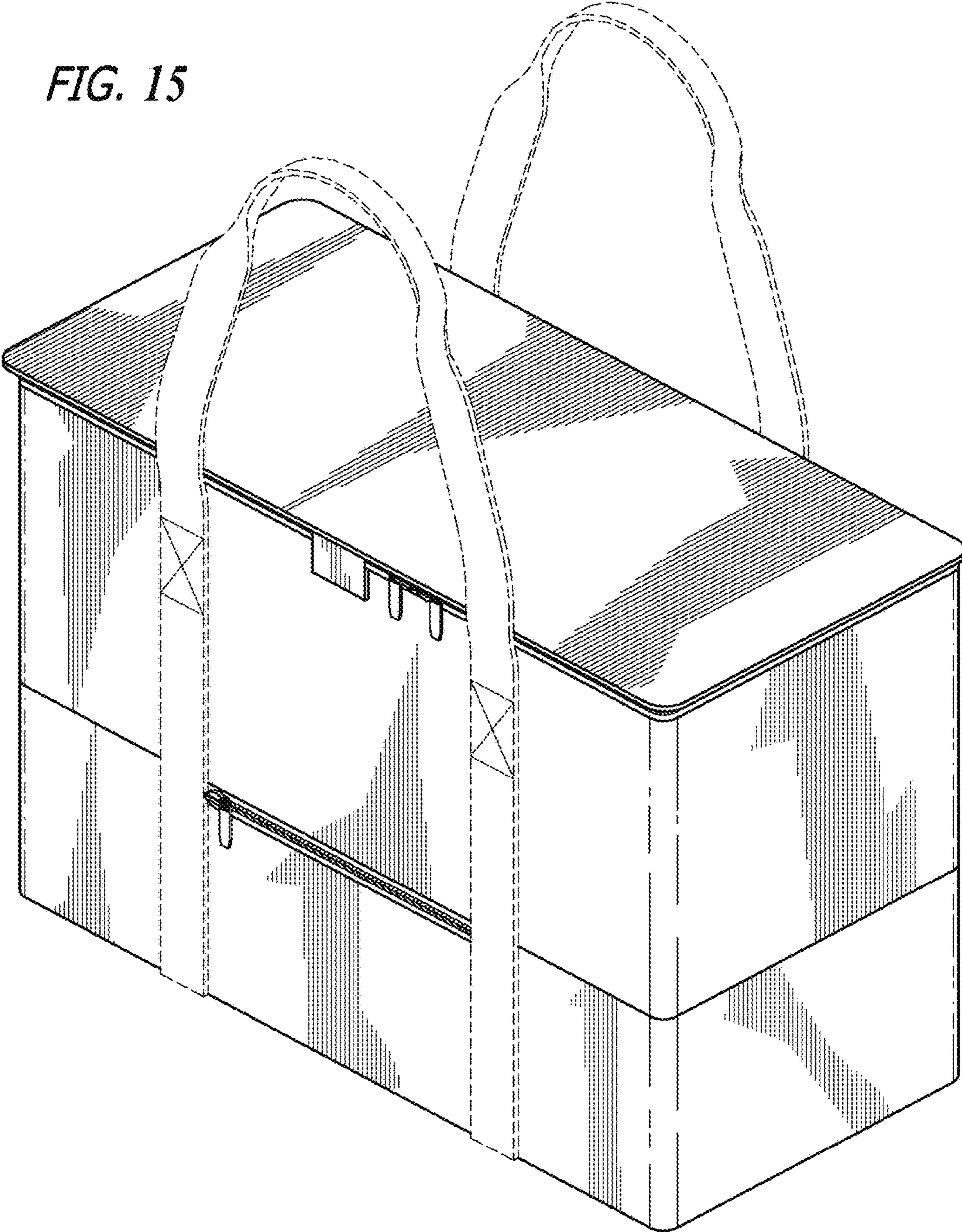
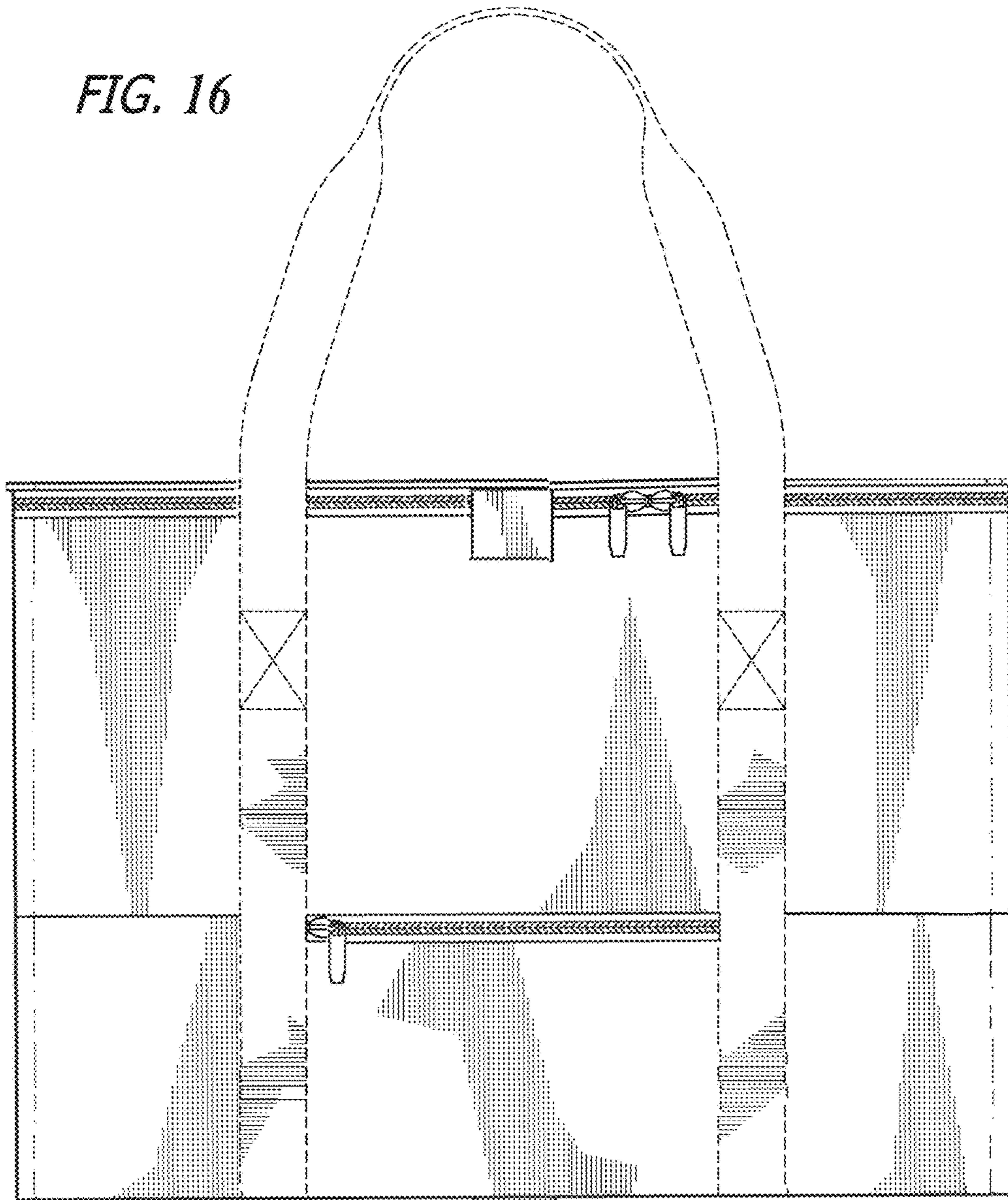




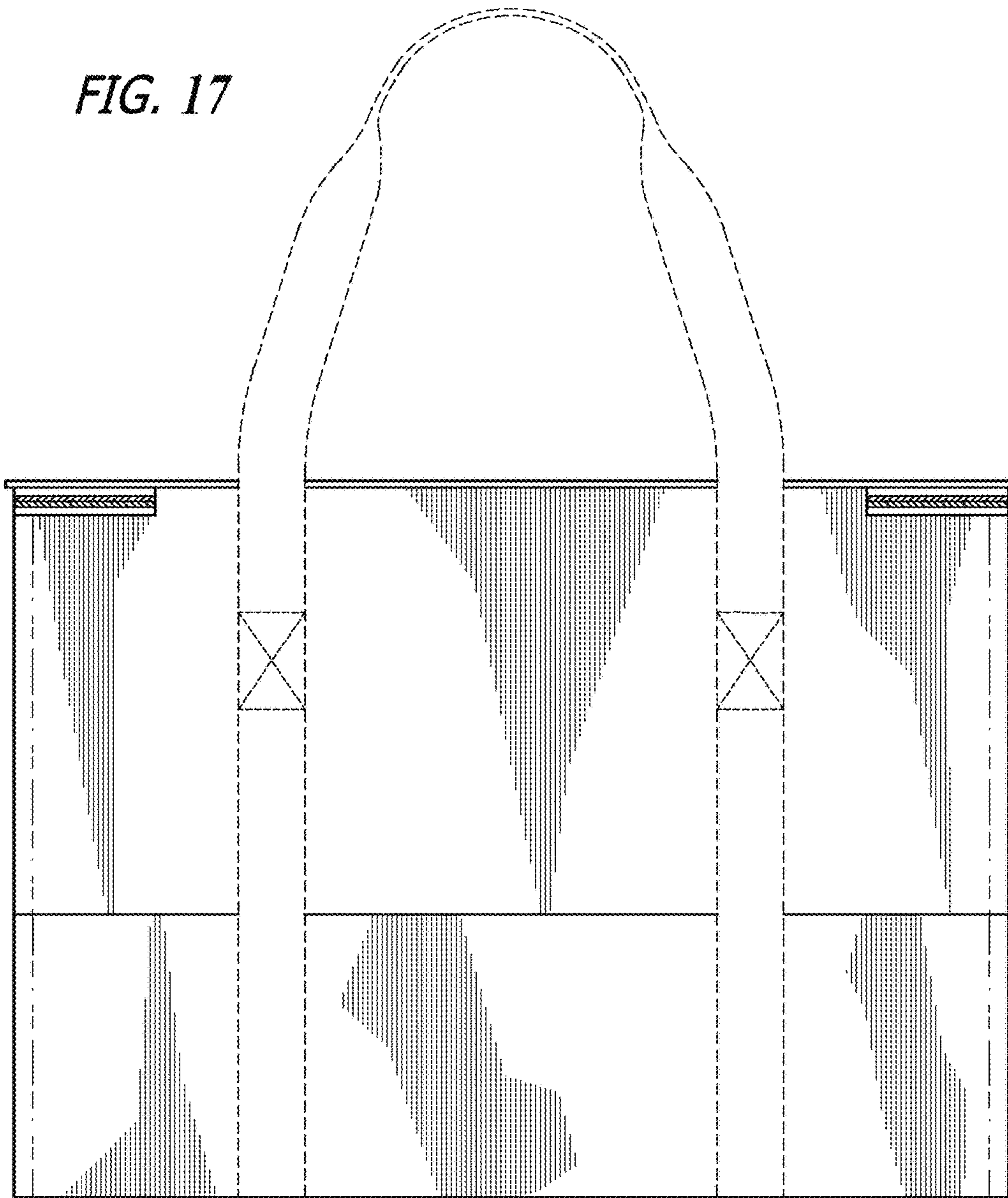
FIG. 15



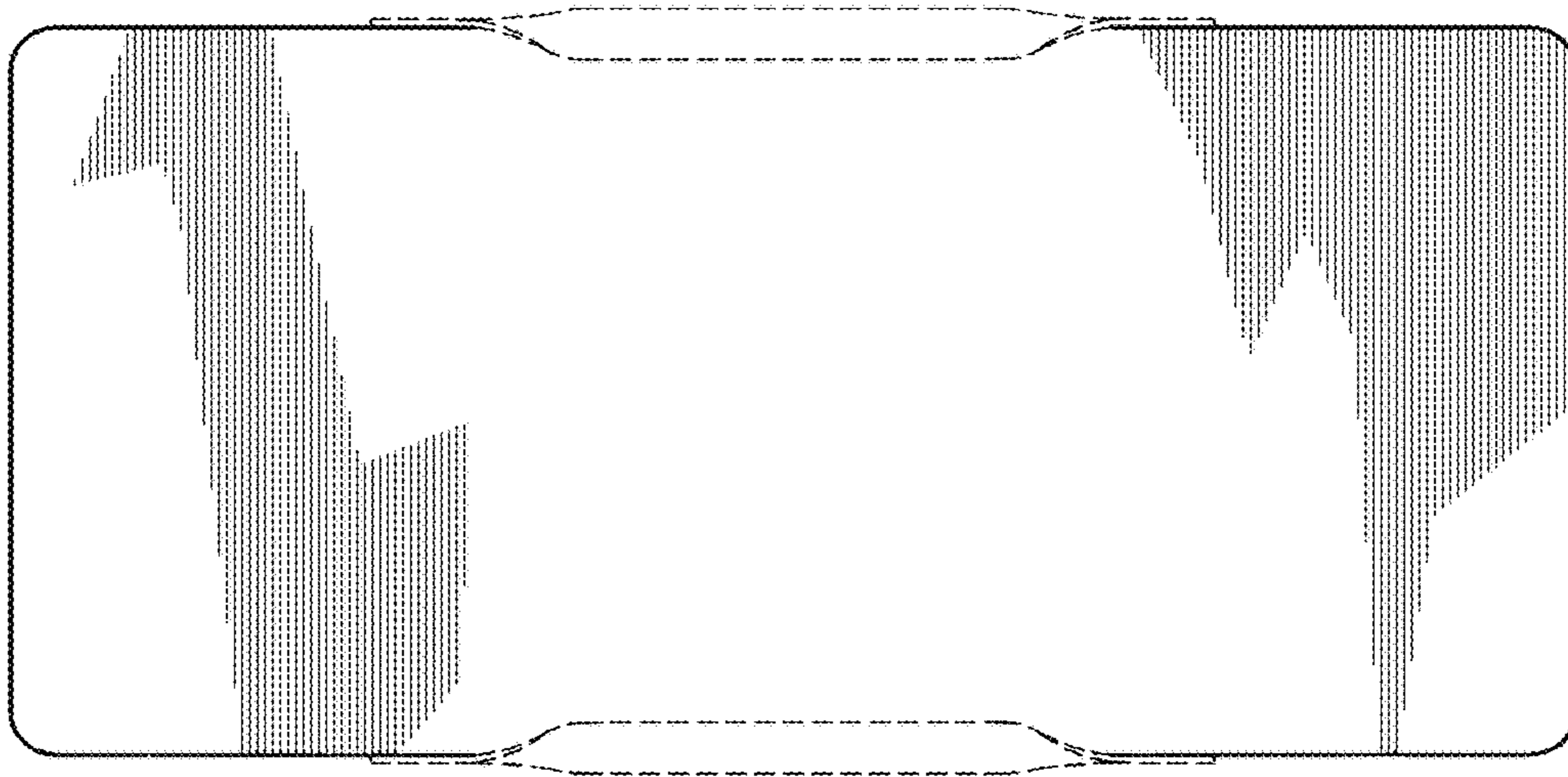
*FIG. 16*



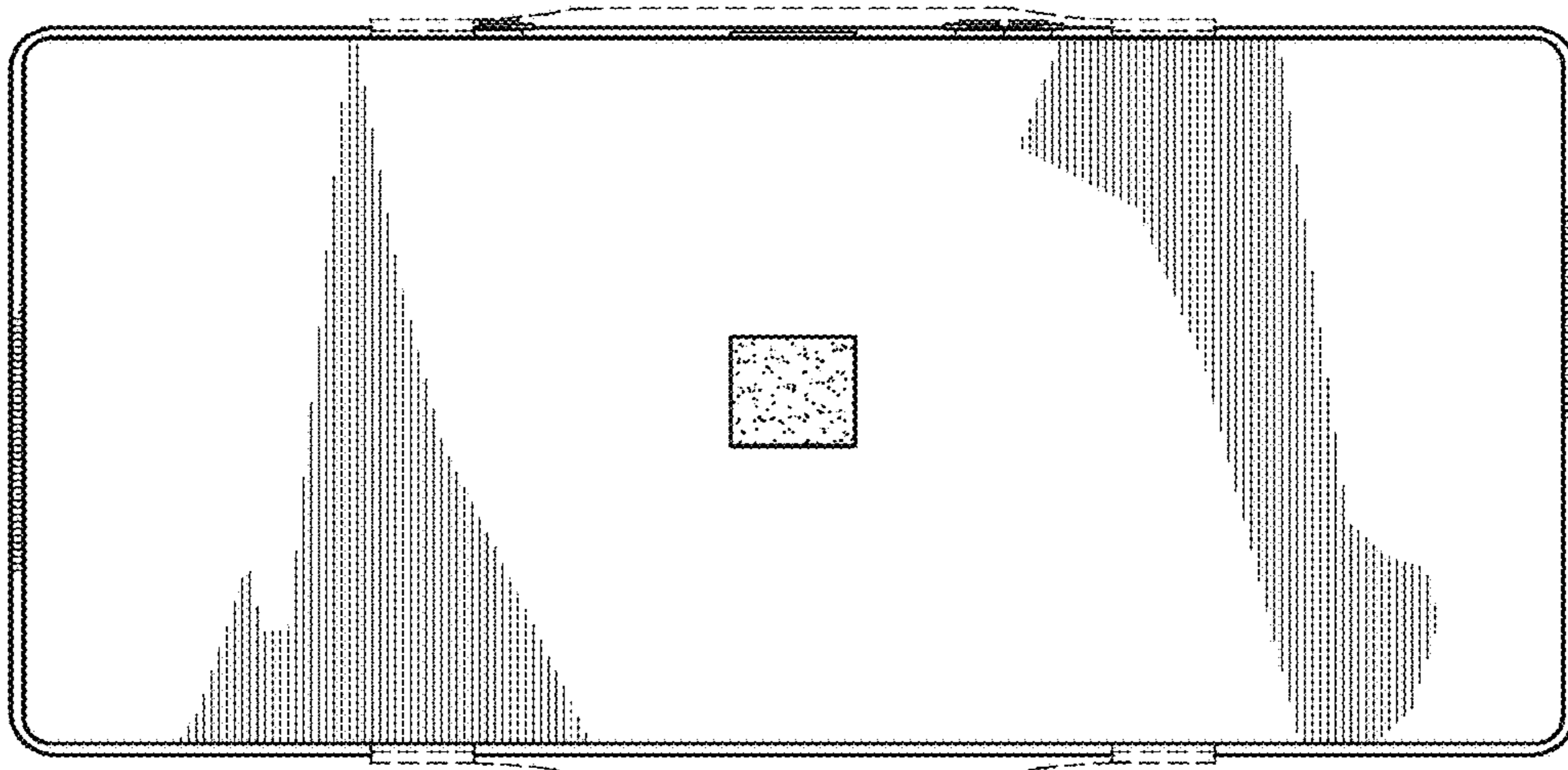
*FIG. 17*





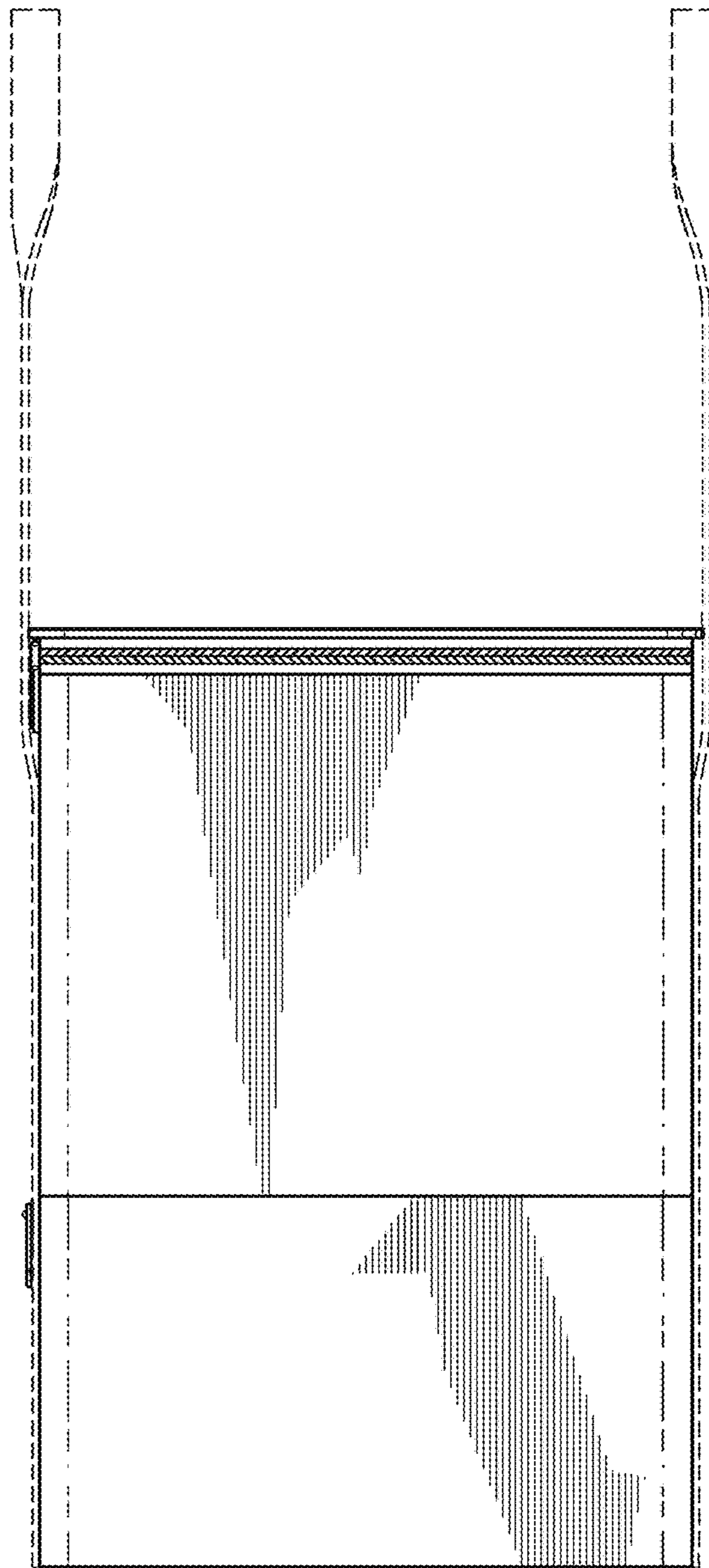


*FIG. 18*



*FIG. 19*

*FIG. 20*



*FIG. 21*

