



US00D861327S

(12) **United States Design Patent** (10) **Patent No.:** **US D861,327 S**
Osmanski et al. (45) **Date of Patent:** **** Oct. 1, 2019**

(54) **TETHER**
(71) Applicant: **NITE IZE, INC.**, Boulder, CO (US)
(72) Inventors: **John Osmanski**, Mequon, WI (US);
Kent Solberg, Whitefish Bay, WI (US);
Bowden Ormsbee, Longmont, CO (US)
(73) Assignee: **Nite Ize, Inc.**, Boulder, CO (US)
(**) Term: **15 Years**

D370,119 S * 5/1996 McDaniel D3/208
D379,830 S * 6/1997 Wasyluk 206/38.1
D380,084 S * 6/1997 Kebarian D3/207
D382,503 S * 8/1997 Kalbach D11/7
D419,289 S * 1/2000 Edwards D3/208
D448,157 S * 9/2001 Wright D3/208
D456,600 S * 5/2002 Gadson D3/208
6,752,305 B2 * 6/2004 Shattuck A45C 11/182
150/145
D495,483 S * 9/2004 Vickers D3/208
D526,119 S * 8/2006 Lederer D3/227
(Continued)

(21) Appl. No.: **29/650,758**
(22) Filed: **Jun. 8, 2018**
(51) **LOC (12) Cl.** **03-01**
(52) **U.S. Cl.**
USPC **D3/207**
(58) **Field of Classification Search**
USPC D3/207-212; D16/100; D26/28;
70/456 B, 457, 458, 408, 456 R;
D13/168; D8/347, 98, 99, 100, 105, 107,
D8/118, 354, 356, 367; D10/104;
D14/496, 411; 206/37.1; 21/604, 605,
21/656, 658, 659; 24/3.6, 457, 458;
D11/11, 79, 81, 82, 86, 87; D32/1, 6, 7,
D32/35, 38, 40, 41, 42, 43, 46; D19/102,
D19/103; 224/259
CPC A45C 11/32; A47G 29/10; H04B 1/034;
F04B 15/00; E05B 19/04; A44B 15/00;
A44B 15/002; A44B 15/005; A44B
15/007; A47L 1/06; A47L 1/09; A47L
1/12; A47L 1/13; A47L 1/15; A47L
9/0606; A47L 9/0613; A47L 9/0633;
A47L 9/066; A47L 13/02; A47L 13/10;
A47L 16/16; A47L 13/17
See application file for complete search history.

(56) **References Cited**
U.S. PATENT DOCUMENTS
4,739,877 A * 4/1988 Olson A44B 15/005
150/900
D308,757 S * 6/1990 Sanford D3/208

OTHER PUBLICATIONS

Nite Ize Hitch Plus Tether, Amazon.com, Oldest Product Review
Date: Oct. 10, 2018, [online], [site visited Apr. 17, 2019]. URL:
<https://www.amazon.com/Nite-Ize-Hitch-Plus-Tether/dp/B07FQWCYMK> (Year: 2018).*
(Continued)

Primary Examiner — T Chase Nelson
Assistant Examiner — Jonathan J. Han
(74) *Attorney, Agent, or Firm* — Haynes and Boone, LLP

(57) **CLAIM**

The ornamental design for the tether, as shown and described.

DESCRIPTION

FIG. 1 shows a front perspective view of a tether;
FIG. 2 shows a rear perspective view of the tether;
FIG. 3 shows a rear view of the tether of FIG. 1;
FIG. 4 shows a front view of the tether of FIG. 1;
FIG. 5 shows a right side view of the tether of FIG. 1;
FIG. 6 shows a left side view of the tether of FIG. 1;
FIG. 7 shows the top view of the tether of FIG. 1; and,
FIG. 8 shows the bottom view of the tether of FIG. 1.

1 Claim, 6 Drawing Sheets

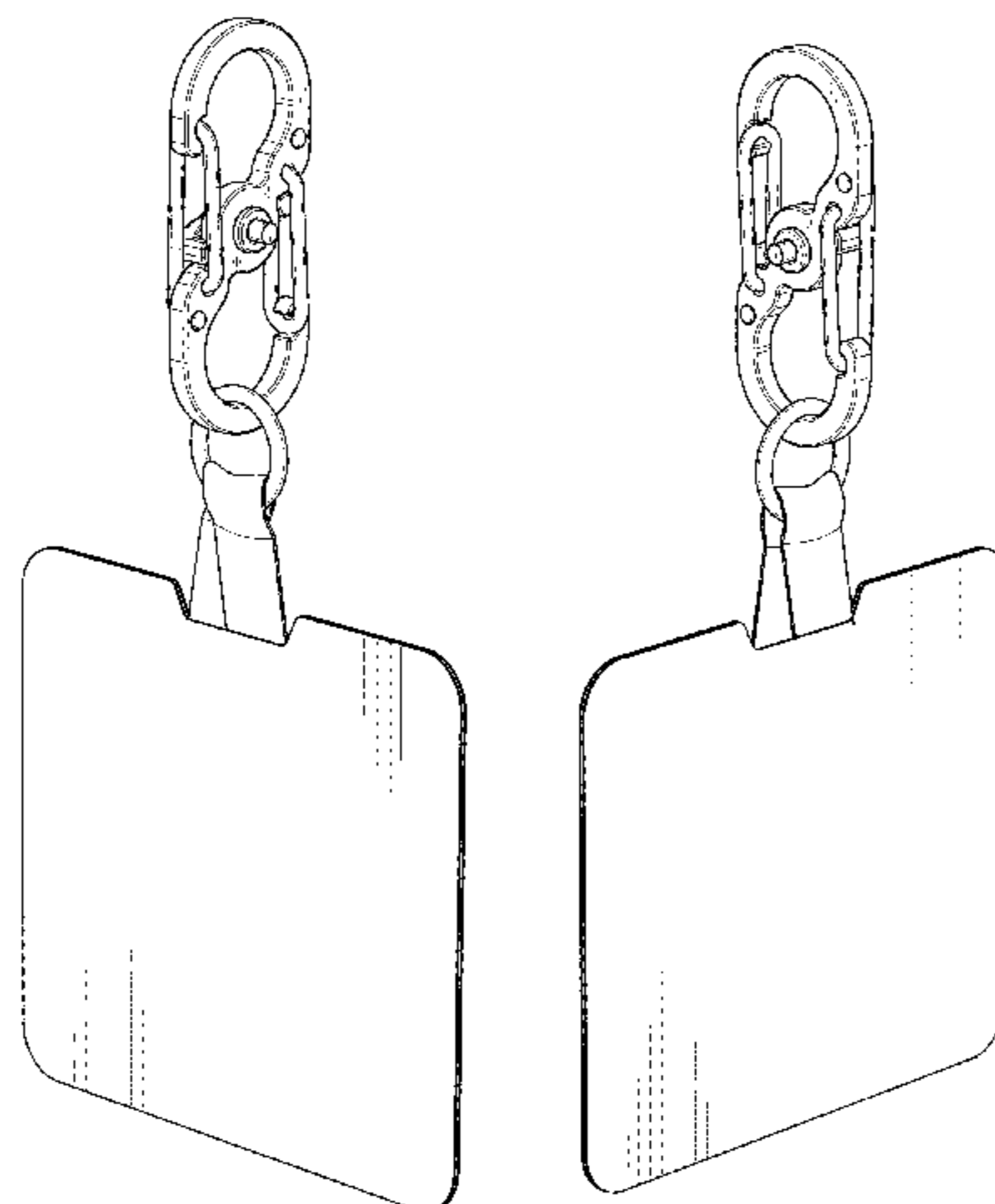

(56)

References Cited

U.S. PATENT DOCUMENTS

D527,891 S * 9/2006 Hoeksema D3/207
 D577,574 S * 9/2008 Liang D8/356
 D596,392 S * 7/2009 Cohen D3/208
 D615,294 S * 5/2010 Liang D3/210
 D621,606 S * 8/2010 Marquardt D3/215
 D626,393 S * 11/2010 Ormsbee D8/18
 D635,446 S * 4/2011 Baca D8/356
 D662,436 S * 6/2012 Kalbach D11/3
 D672,278 S * 12/2012 Kalbach D11/201
 D677,842 S * 3/2013 Kalbach D30/153
 D679,218 S * 4/2013 Kalbach D11/200
 D698,625 S * 2/2014 Liang D8/356
 D698,626 S * 2/2014 Ormsbee D8/356
 D699,144 S * 2/2014 Kalbach D11/3
 D723,795 S * 3/2015 Kalbach D3/218
 D728,837 S * 5/2015 Ormsbee D26/38
 D729,476 S * 5/2015 Haarburger D32/35
 9,441,665 B2 * 9/2016 Liang F16B 45/02
 9,476,446 B2 * 10/2016 Ormsbee F16B 45/02
 9,521,939 B2 * 12/2016 Haarburger A47L 13/11

D781,570 S * 3/2017 Andersen D3/215
 D784,682 S * 4/2017 Ormsbee D3/207
 D804,810 S * 12/2017 Schmiedeberg D3/215

OTHER PUBLICATIONS

Frog's Tung Tactical Military Grade Cable Cell Phone Leash, Amazon.com, Oldest Product Review Date: Feb. 15, 2017, [online], [site visited Apr. 17, 2019]. URL: [\(https://www.amazon.com/dp/B00KRPDZU/ref=sspa_dk_detail_7?psc=1&pd_rd_i=B00KRPDZU&pd_rd_w=bzXsf&pf_rd\)](https://www.amazon.com/dp/B00KRPDZU/ref=sspa_dk_detail_7?psc=1&pd_rd_i=B00KRPDZU&pd_rd_w=bzXsf&pf_rd) (Year: 2017).*

Squids 3195 Cell Phone Tool Tethering Kit—1lb/0.5kg, Ergodyne.com, [online], [site visited Apr. 17, 2019]. URL: <https://www.ergodyne.com/lanyards/tool-tethering-kits/squids-3195-cell-phone-tool-tethering-kit-1lbs-0-5kg.html> (Year: 2019).*

Wander Bundle Smartphone Safety Tether System, Blackrapid.com, Oldest Product Review on Website: Jul. 25, 2017 8:02pm, [online], [site visited Apr. 17, 2019]. URL: <http://www.blackrapid.com/Wander-Bundle> (Year: 2017).*

* cited by examiner

FIG. 1

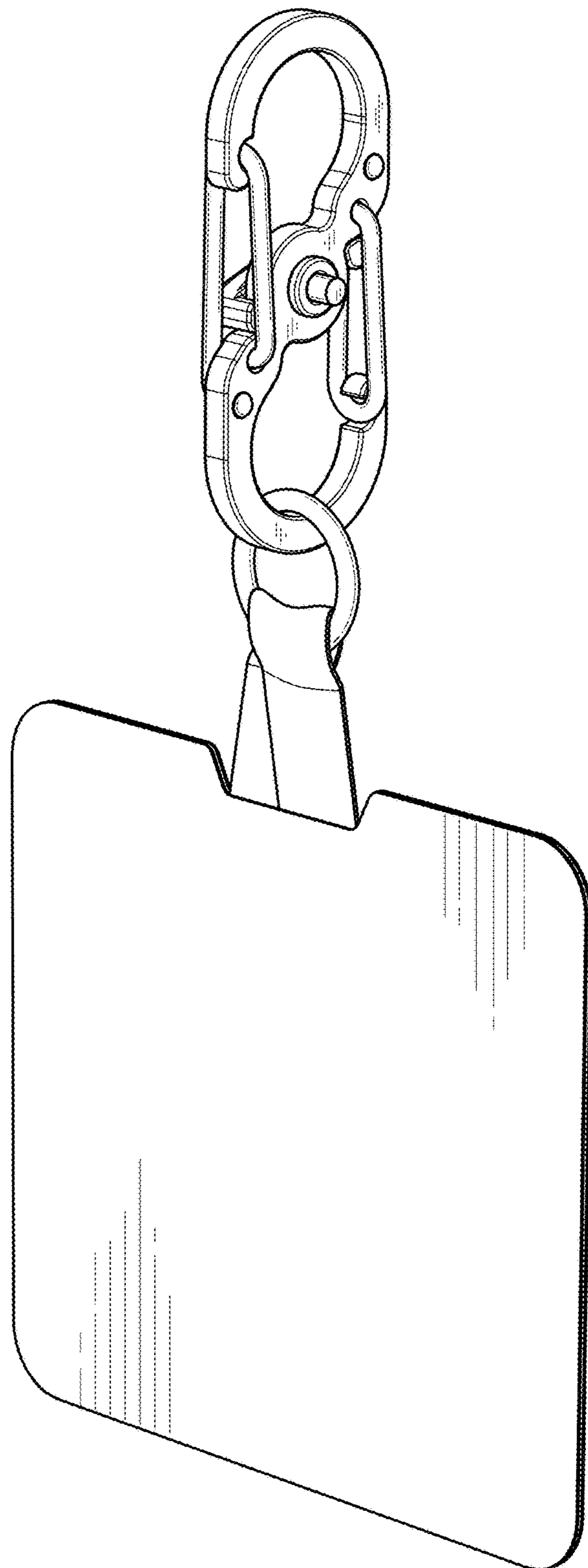

FIG. 2

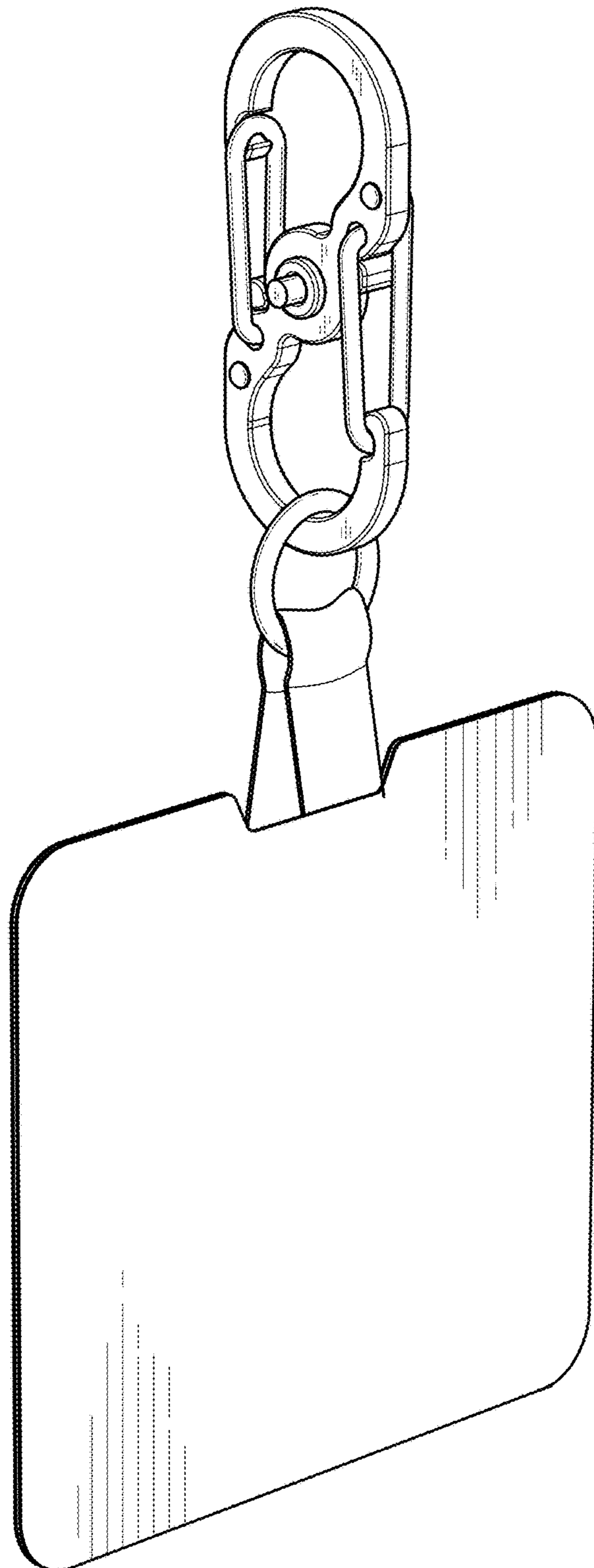

FIG. 3

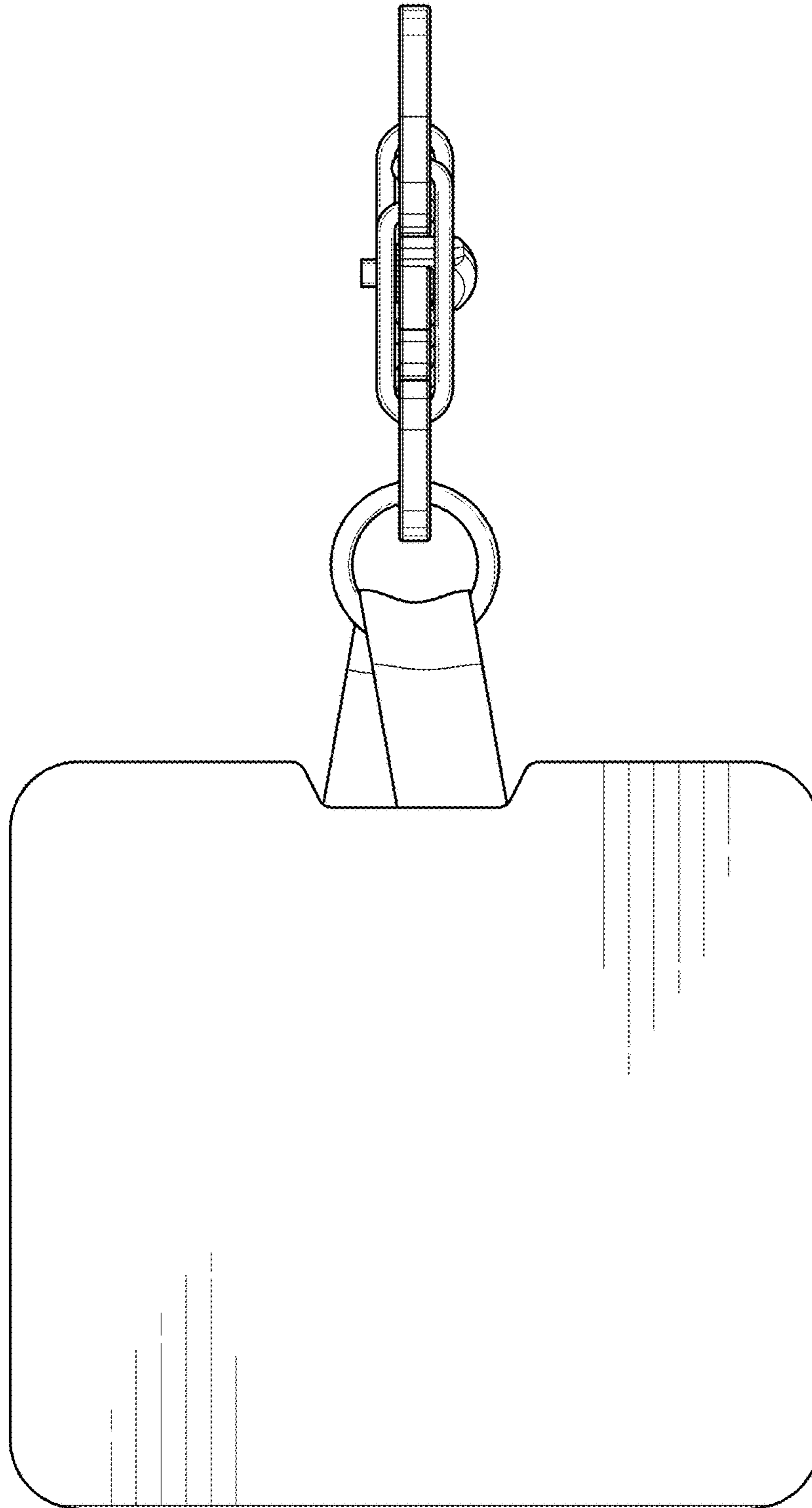

FIG. 4

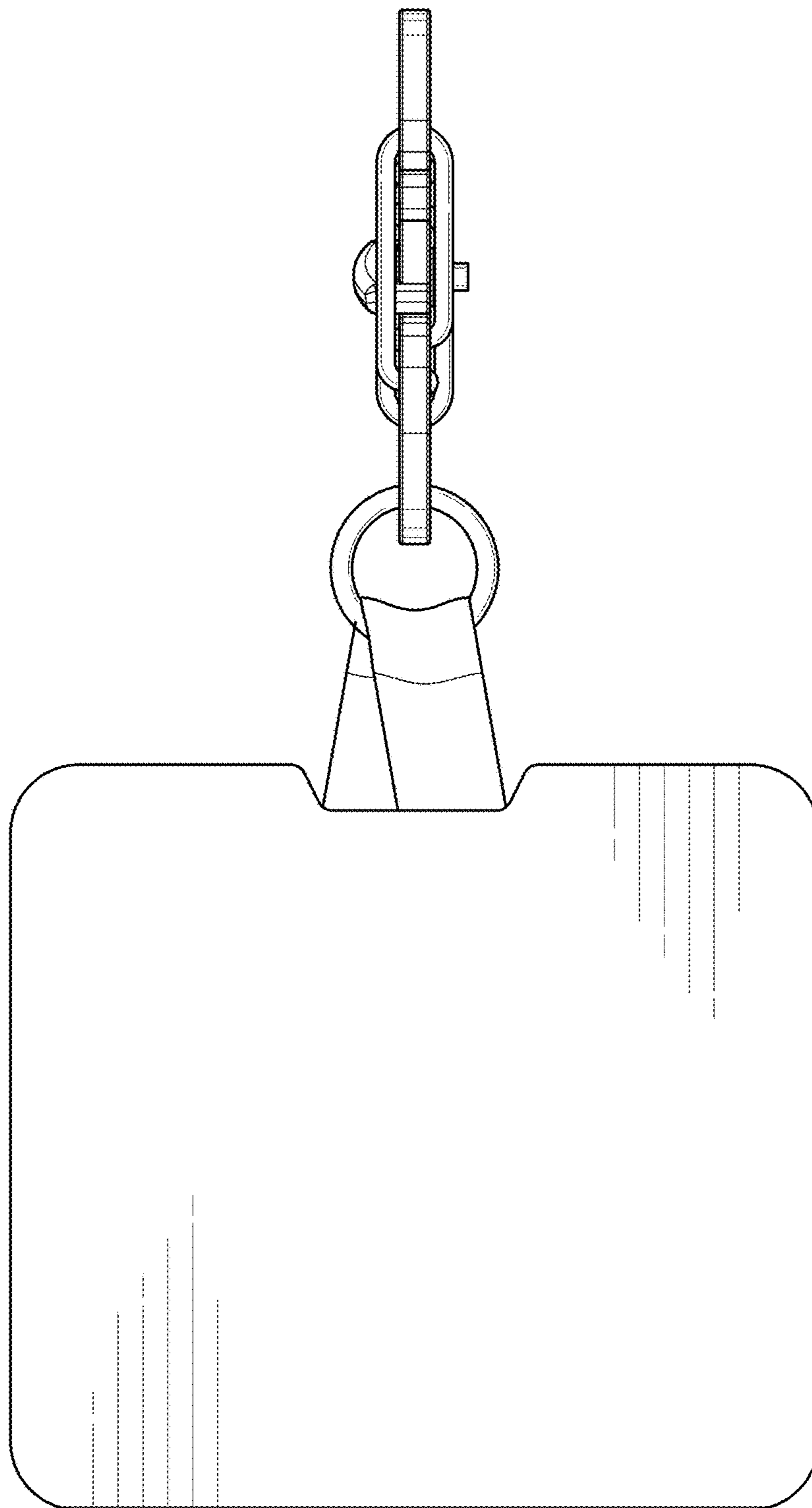

FIG. 5

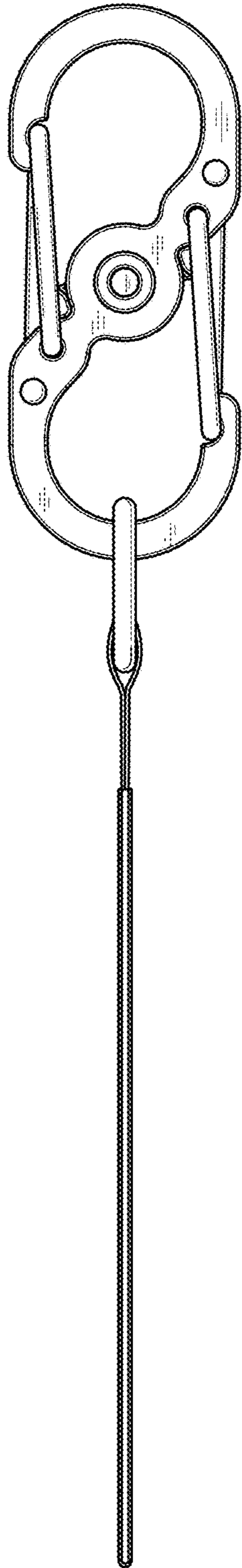

FIG. 6

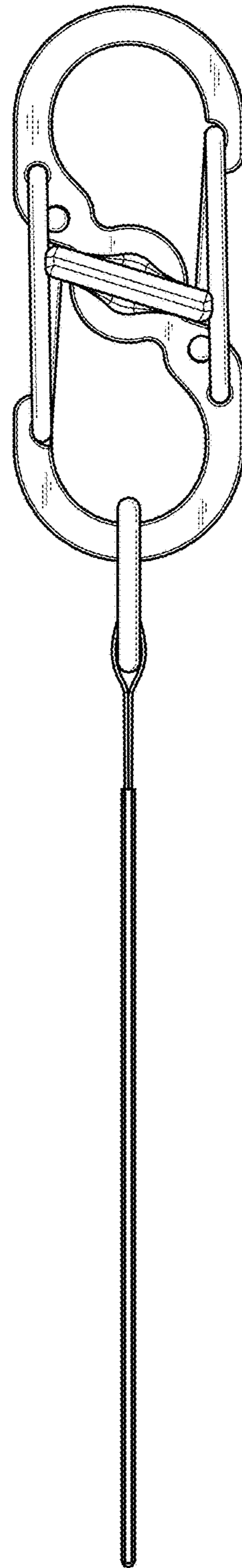

FIG. 7

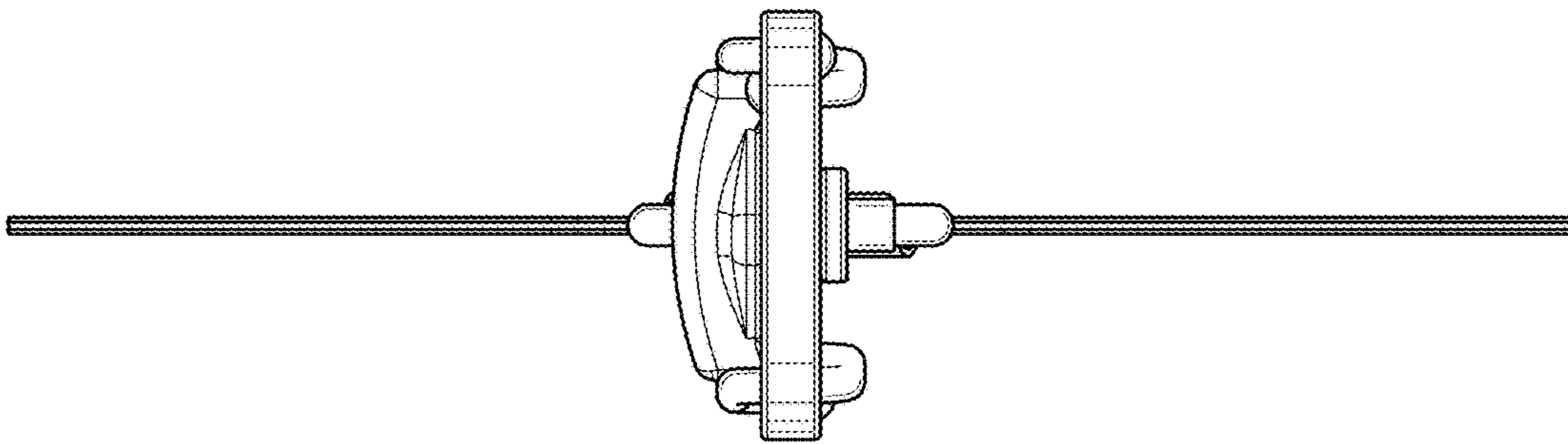

FIG. 8

