



US00D861226S

(12) **United States Design Patent**
Liu

(10) **Patent No.:** **US D861,226 S**

(45) **Date of Patent:** **** Sep. 24, 2019**

(54) **SOLAR LAMP**

(71) Applicant: **Shenzhen Ennoplus Technology Co., Ltd.**, Shenzhen (CN)

(72) Inventor: **Hangyu Liu**, Shenzhen (CN)

(73) Assignee: **SHENZHEN ENNOPLUS TECHNOLOGY CO., LTD.**, Shenzhen (CN)

(**) Term: **15 Years**

(21) Appl. No.: **29/676,665**

(22) Filed: **Jan. 14, 2019**

Related U.S. Application Data

(63) Continuation-in-part of application No. 29/657,854, filed on Jul. 26, 2018, now Pat. No. Des. 844,213.

(51) **LOC (12) Cl.** **26-03**

(52) **U.S. Cl.**
USPC **D26/85**

(58) **Field of Classification Search**
USPC D26/72, 80, 85, 89; D10/106.6, 106.8
CPC F21S 8/03; F21S 8/033; F21S 8/036; F21S 8/037; F21S 9/022; F21S 9/024; F21S 9/03; F21S 9/035; F21S 9/037; F21W 2131/107; G08B 13/193
See application file for complete search history.

(56) **References Cited**

U.S. PATENT DOCUMENTS

D231,630 S * 5/1974 Sherry D26/85
4,015,163 A * 3/1977 Iacobelli F21S 8/033
312/238

D284,109 S * 6/1986 Seal, Jr. D26/24
D394,124 S * 5/1998 Mackert D10/104.1
D822,874 S * 7/2018 Hu D26/85
D835,830 S * 12/2018 Liu D26/85
D841,865 S * 2/2019 Deng D26/85
D844,213 S * 3/2019 Liu D26/85
D848,658 S * 5/2019 Tan D26/85
D849,988 S * 5/2019 Li D26/85
2017/0321877 A1* 11/2017 Polidoro F21S 8/033

* cited by examiner

Primary Examiner — Clare E Heflin

(57) **CLAIM**

The ornamental design for a solar lamp, as shown and as described.

DESCRIPTION

FIG. 1 is a first perspective view of an embodiment of a solar lamp showing my new design;
FIG. 2 is a second perspective view of the embodiment of a solar lamp showing my new design;
FIG. 3 is a front elevation view of the embodiment thereof;
FIG. 4 is a rear elevation view of the embodiment thereof;
FIG. 5 is a left side elevation view of the embodiment thereof;
FIG. 6 is a right side elevation view of the embodiment thereof;
FIG. 7 is a top plan view of the embodiment thereof; and,
FIG. 8 is a bottom plan view of the embodiment thereof.
The broken lines in FIG. 1 through FIG. 8 illustrate portions of the solar lamp which form no part of the claimed design.

1 Claim, 8 Drawing Sheets

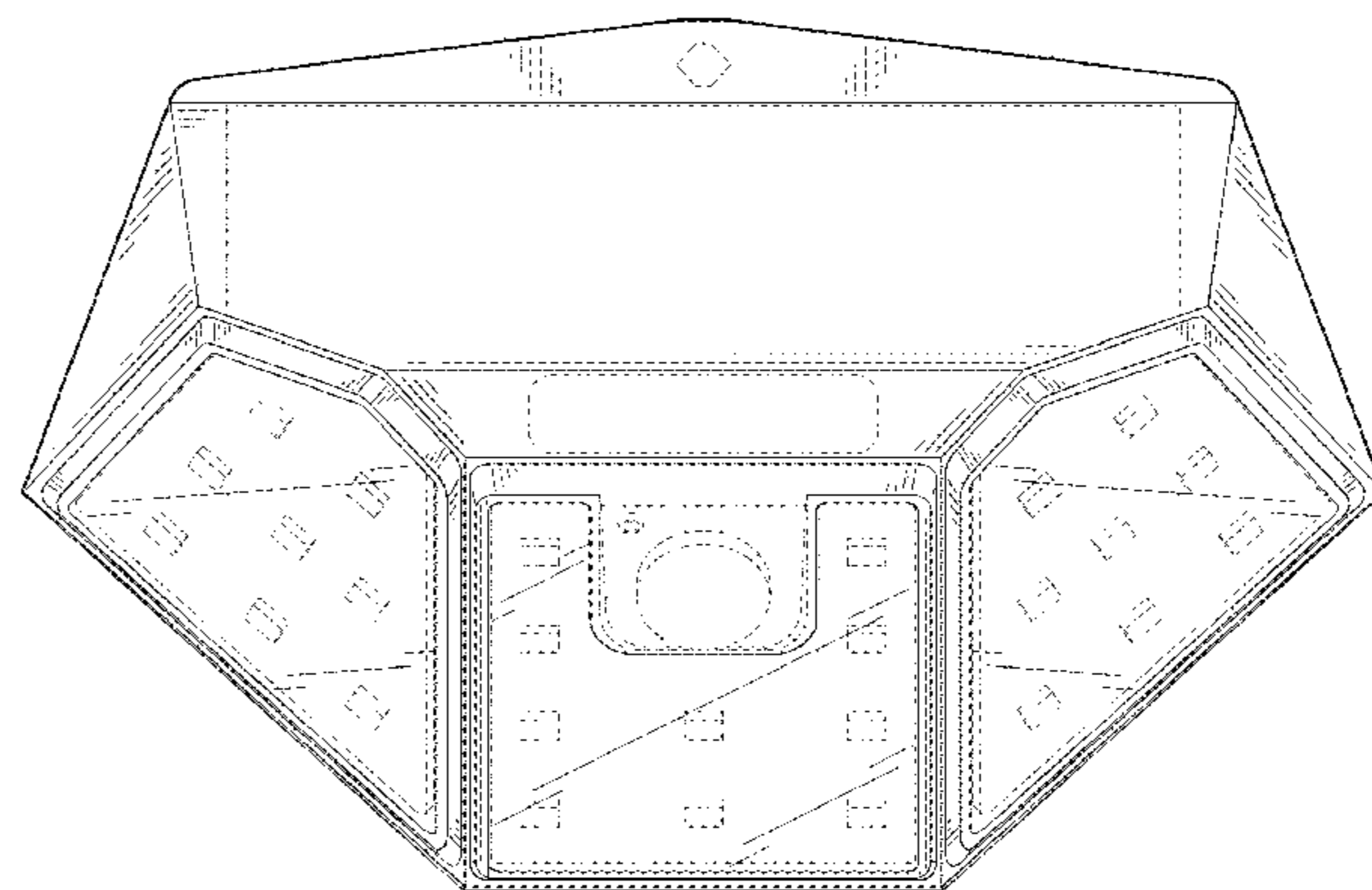
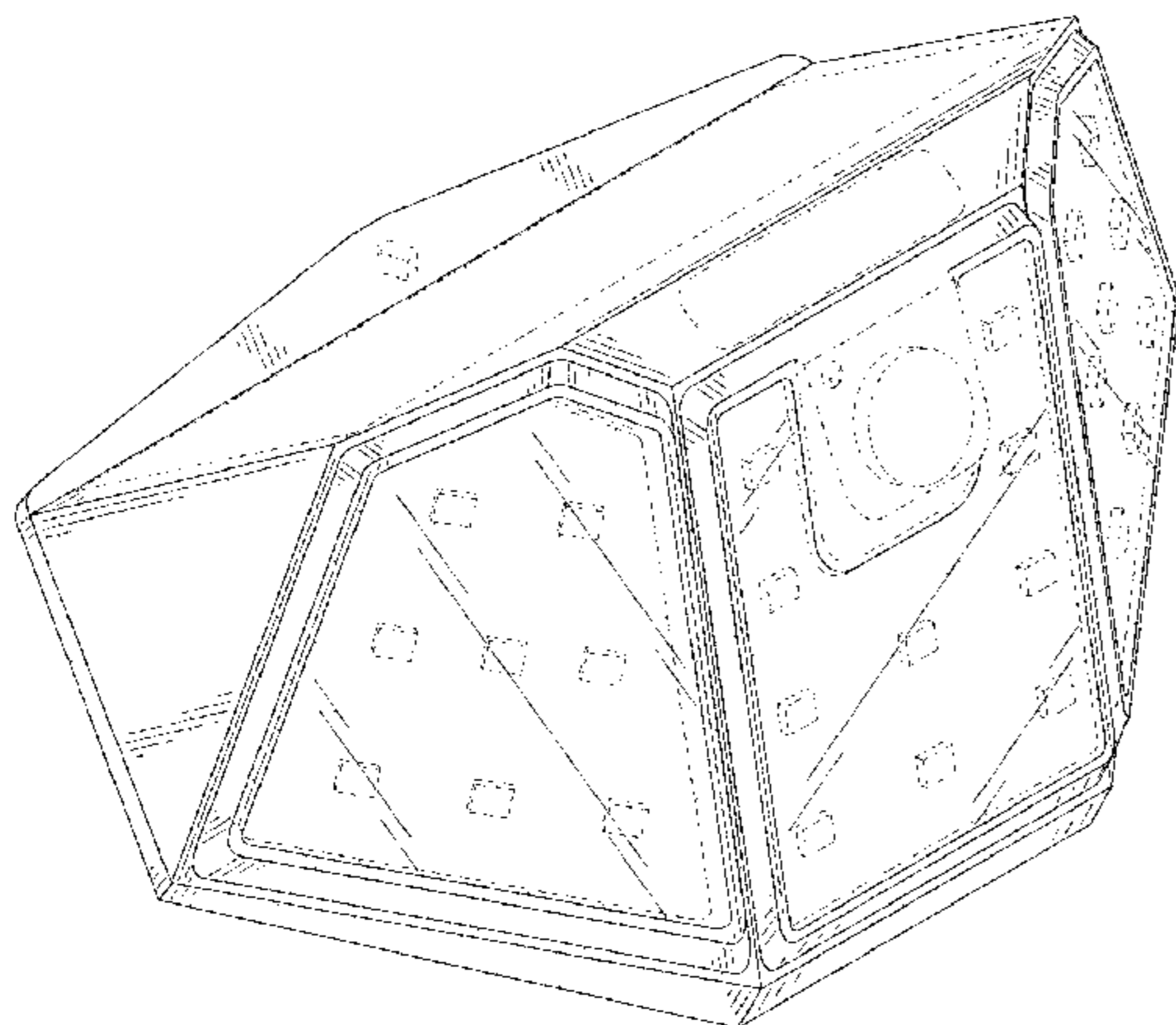

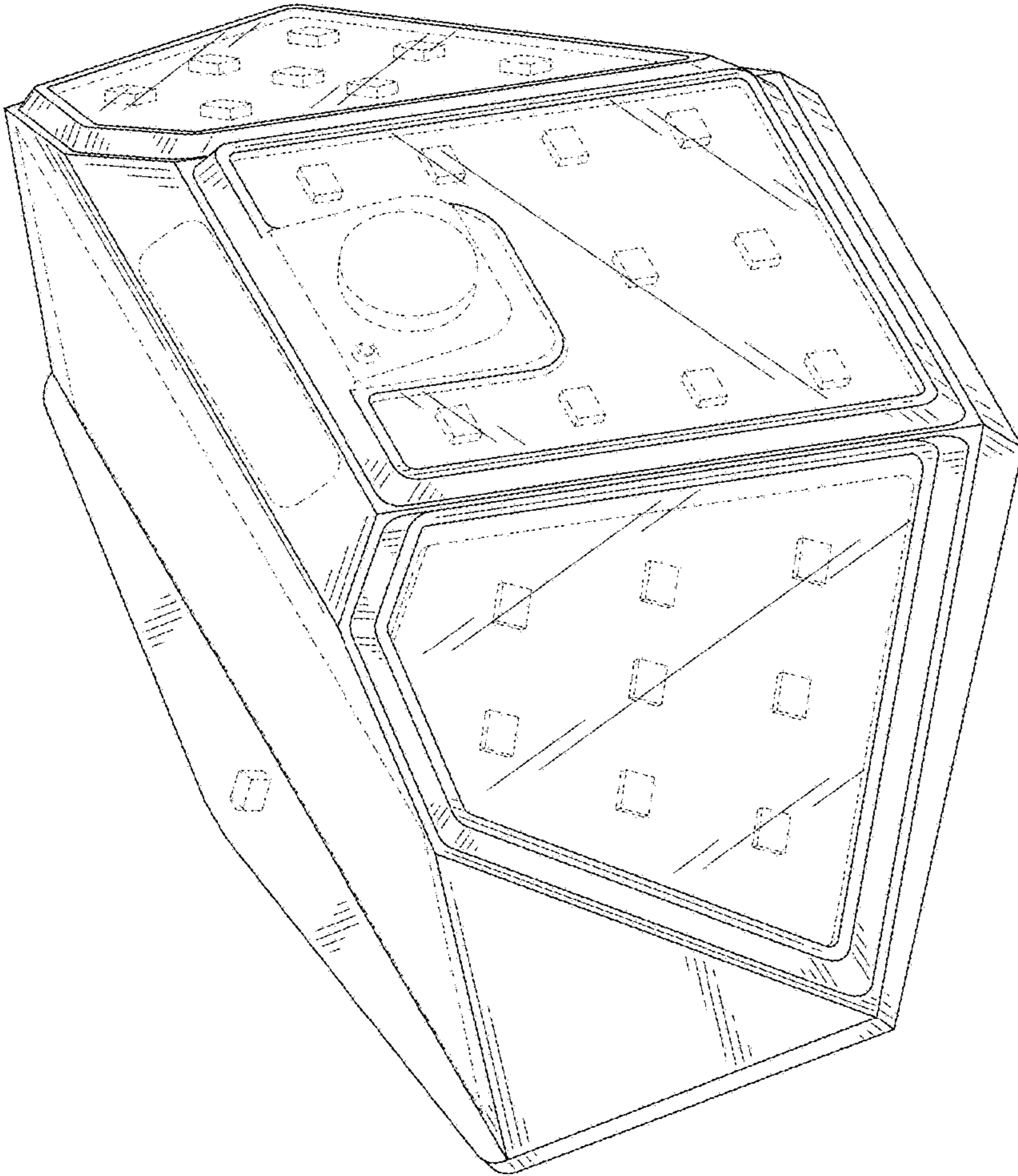

FIG. 1

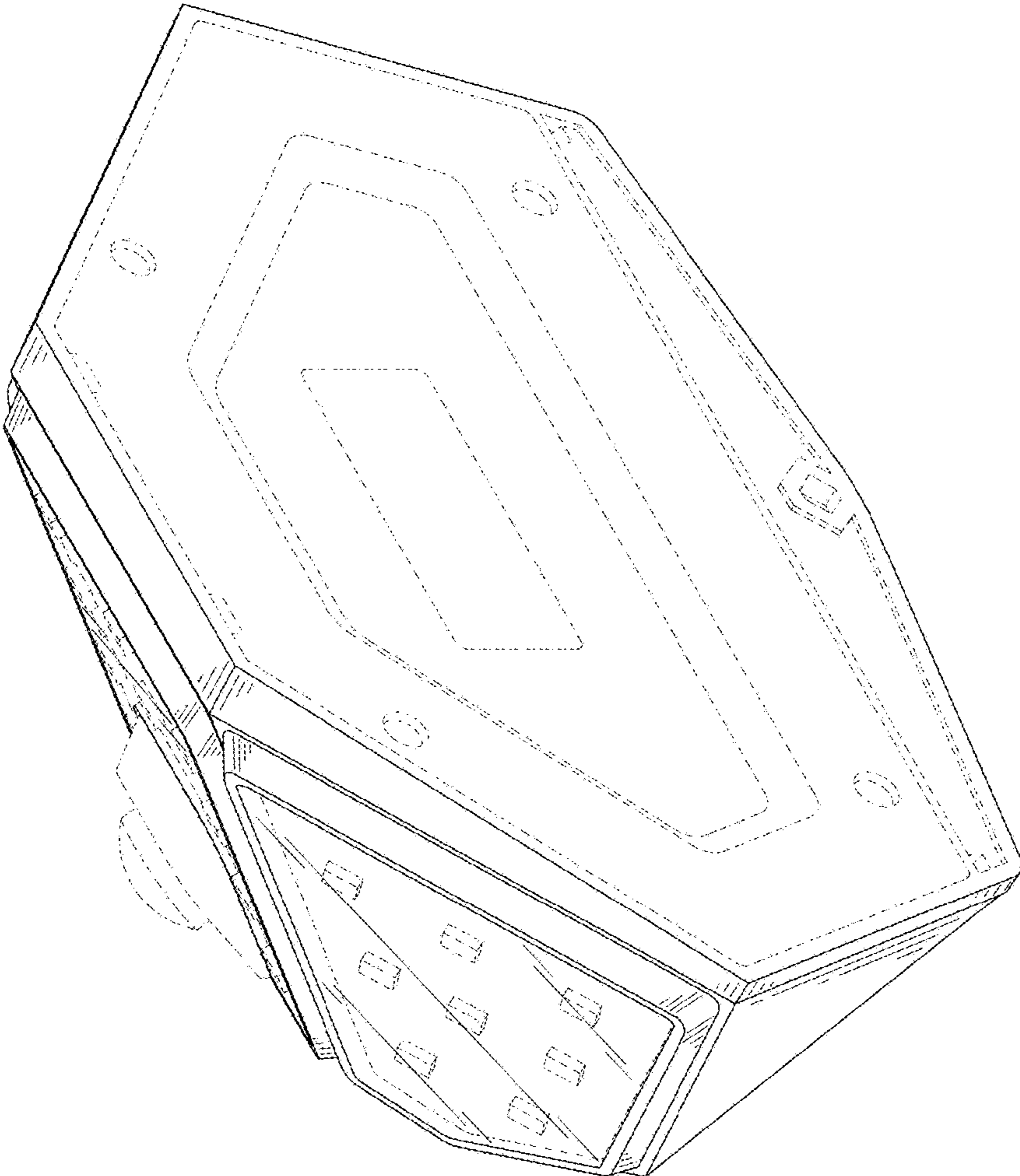

FIG. 2

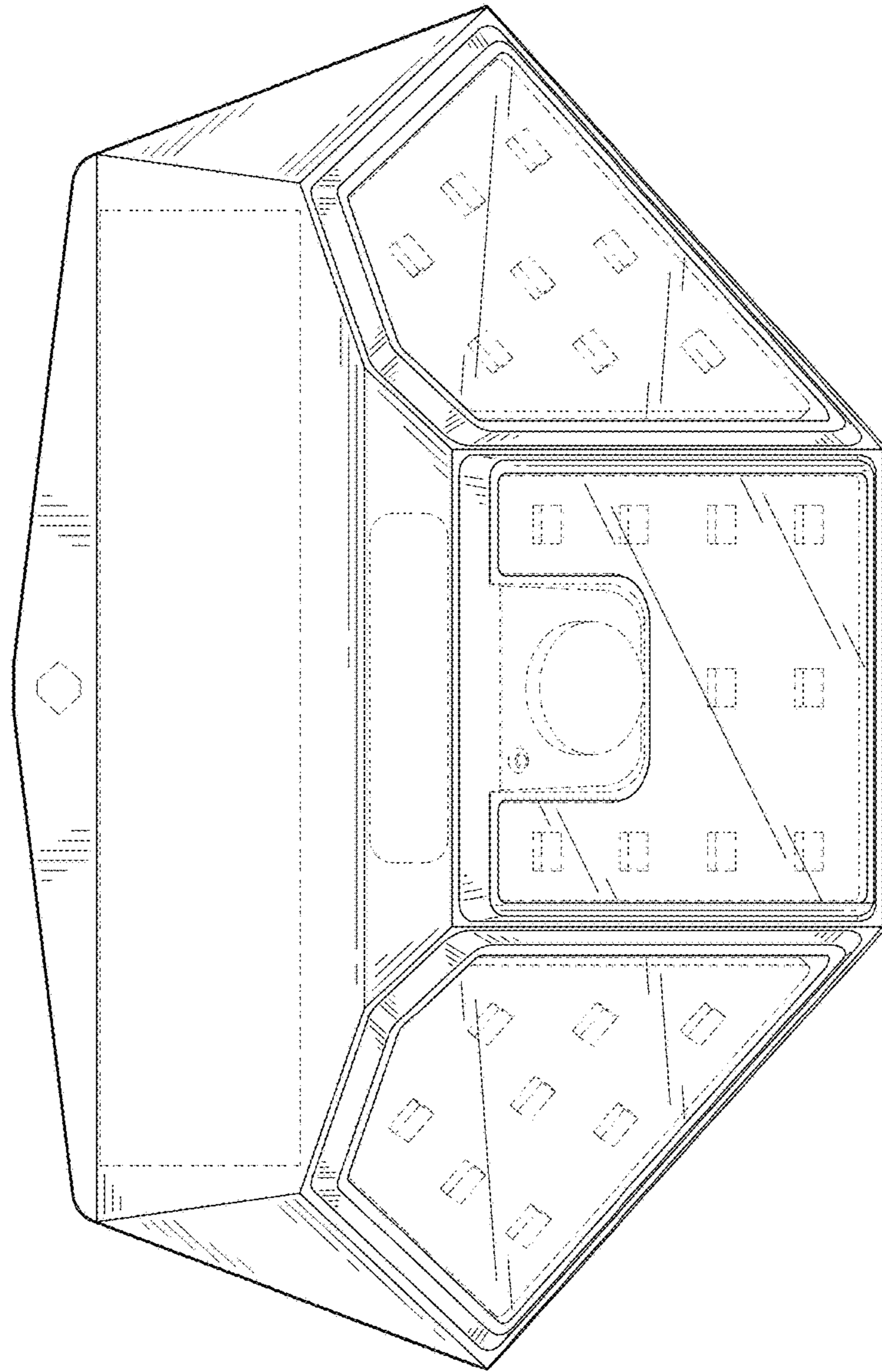

FIG. 3

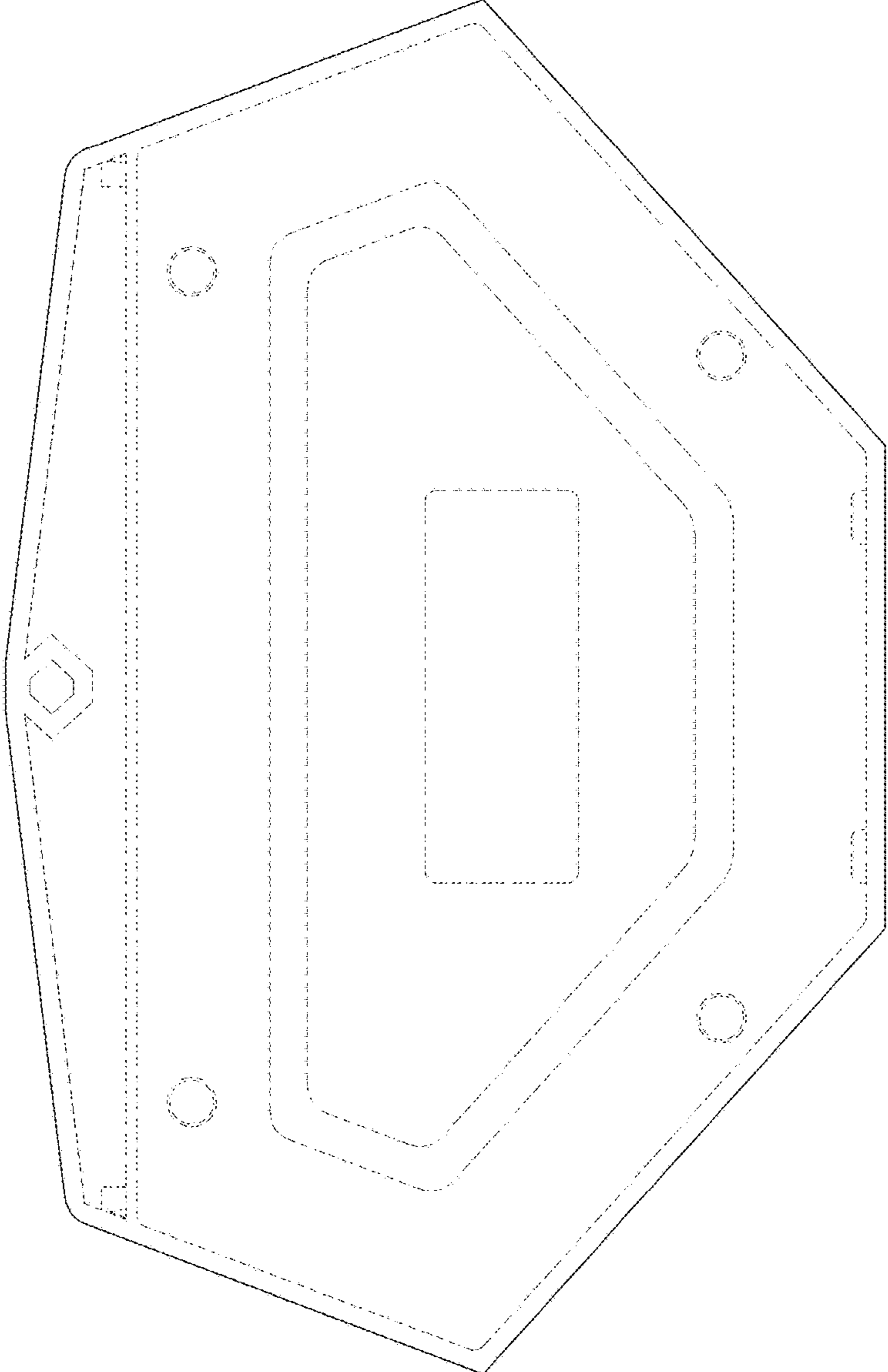

FIG. 4

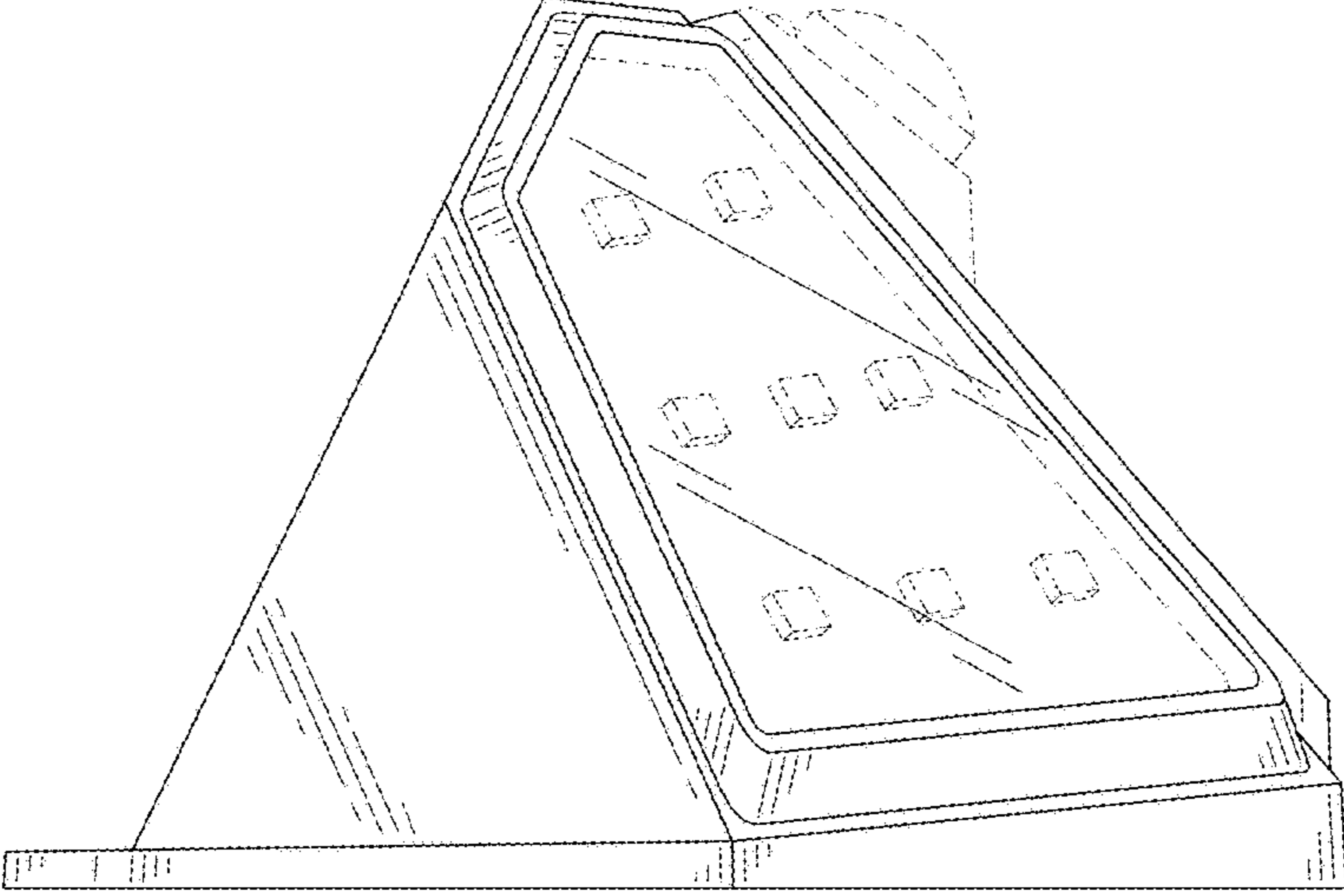

FIG. 5

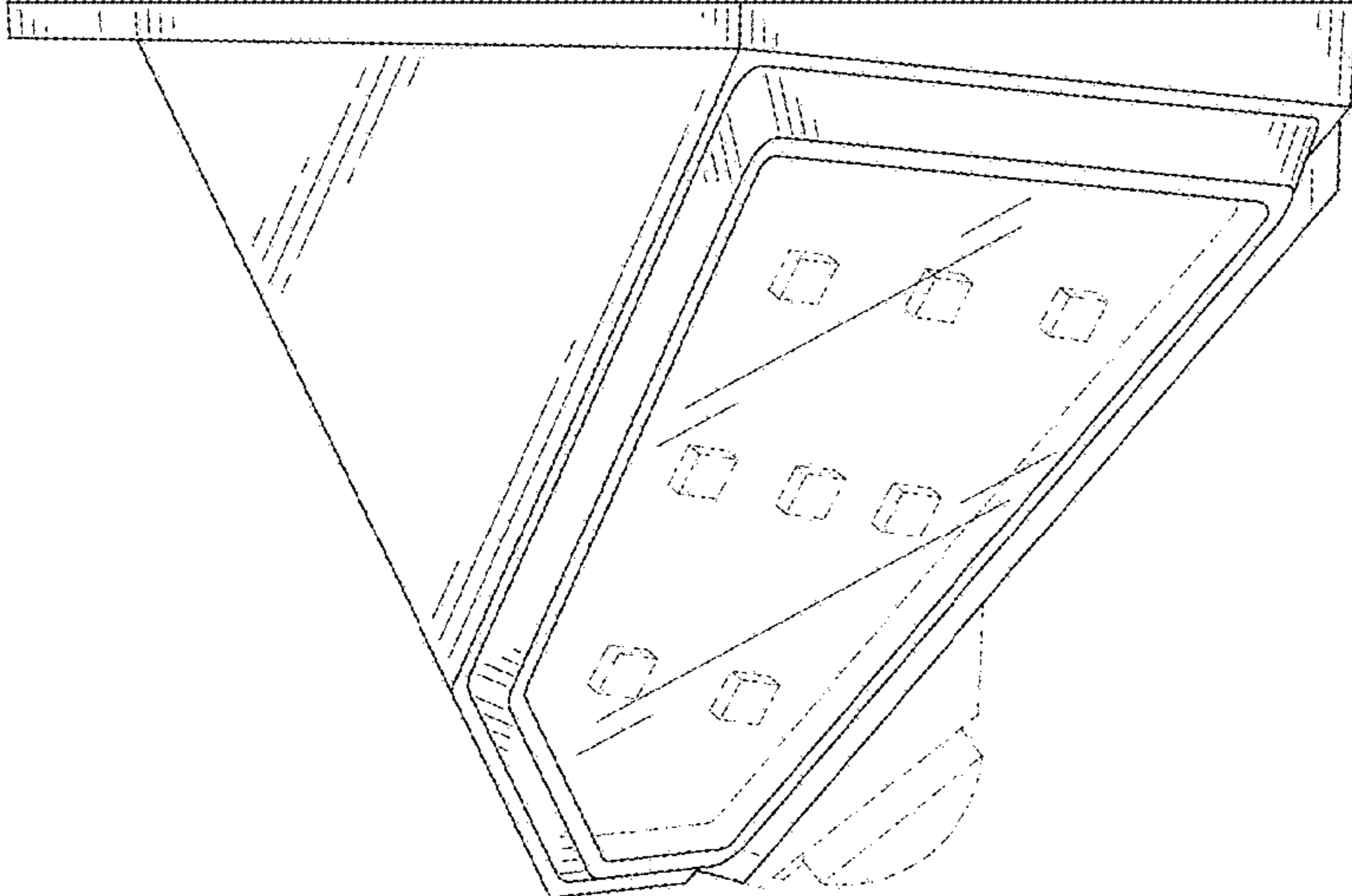

FIG. 6

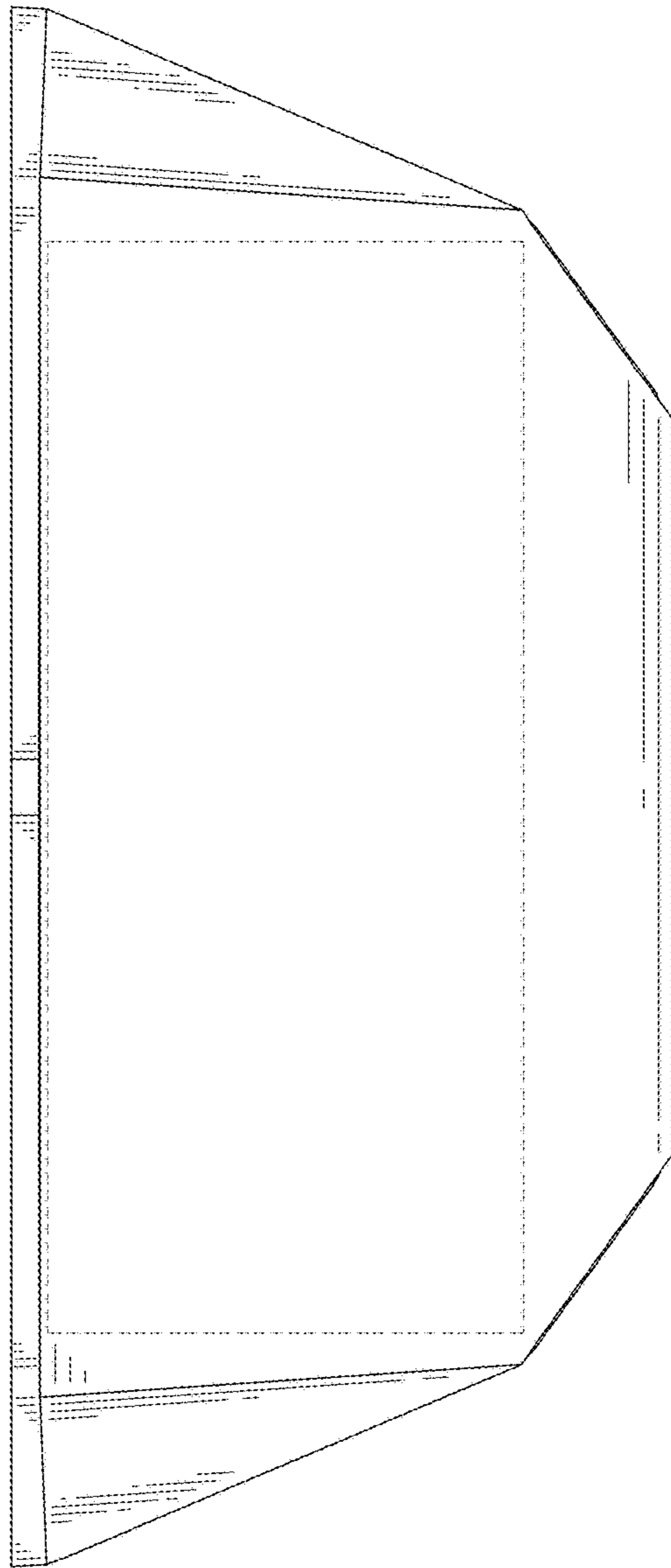

FIG. 7

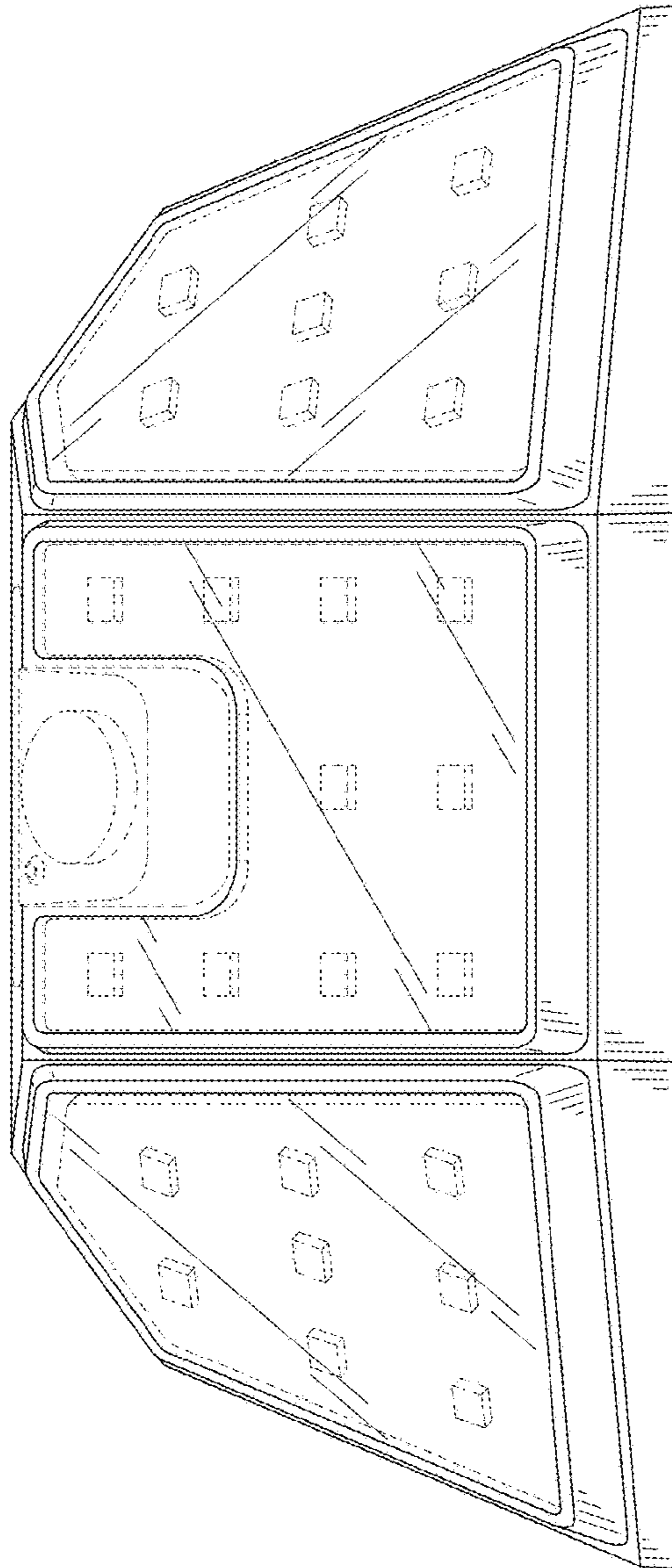

FIG. 8