



US00D861221S

(12) **United States Design Patent** (10) **Patent No.:** **US D861,221 S**
Chen et al. (45) **Date of Patent:** **** Sep. 24, 2019**

(54) **STAKE LIGHT**

(71) Applicant: **QUANZHOU JINTION ELECTRONICS CO., LTD**, Fujian (CN)

(72) Inventors: **Wenming Chen**, Fujian (CN); **Wenhong Chen**, Fujian (CN)

(73) Assignee: **QUANZHOU JINTION ELECTRONICS CO., LTD**, Fujian (CN)

(**) Term: **15 Years**

(21) Appl. No.: **29/646,261**

(22) Filed: **May 2, 2018**

(51) **LOC (12) Cl.** **26-03**

(52) **U.S. Cl.**
USPC **D26/68**

(58) **Field of Classification Search**
USPC **D26/63, 67-70; D13/102**
(Continued)

(56) **References Cited**

U.S. PATENT DOCUMENTS

D499,831 S * 12/2004 Chen D26/67
D499,833 S * 12/2004 Chen D26/67

(Continued)

FOREIGN PATENT DOCUMENTS

CN 301648915 * 8/2011
CN 302223594 * 12/2012

Primary Examiner — Cathron C Brooks

(74) *Attorney, Agent, or Firm* — JCIPRNET

(57) **CLAIM**

The ornamental design for a stake light, as shown and described.

DESCRIPTION

FIG. 1 is a perspective view of a stake light showing a first embodiment of our new design;
FIG. 2 is a front view of the first embodiment;
FIG. 3 is a rear view of the first embodiment;
FIG. 4 is a left side view of the first embodiment;
FIG. 5 is a right side view of the first embodiment;
FIG. 6 is an enlarged top view of the first embodiment;
FIG. 7 is an enlarged bottom view of the first embodiment;
FIG. 8 is another perspective view of the first embodiment;
FIG. 9 is an enlarged view of the portion so indicated in FIG. 8;

FIG. 10 is an enlarged view of the portion so indicated in FIG. 2;

FIG. 11 is an enlarged view of the portion so indicated in FIG. 4;

FIG. 12 is a perspective view of a stake light showing a second embodiment of our new design;

FIG. 13 is a front view of the second embodiment;

FIG. 14 is a rear view of the second embodiment;

FIG. 15 is a left side view of the second embodiment;

FIG. 16 is a right side view of the second embodiment;

FIG. 17 is an enlarged top view of the second embodiment;

FIG. 18 is an enlarged bottom view of the second embodiment;

FIG. 19 is another perspective view of the second embodiment;

FIG. 20 is an enlarged view of the portion so indicated in FIG. 19;

FIG. 21 is an enlarged view of the portion so indicated in FIG. 13; and,

FIG. 22 is an enlarged view of the portion so indicated in FIG. 15.

The broken lines shown in the accompanying drawings indicate cutoff boundaries for enlarged detailed portion views and form no part of the claim.

1 Claim, 16 Drawing Sheets

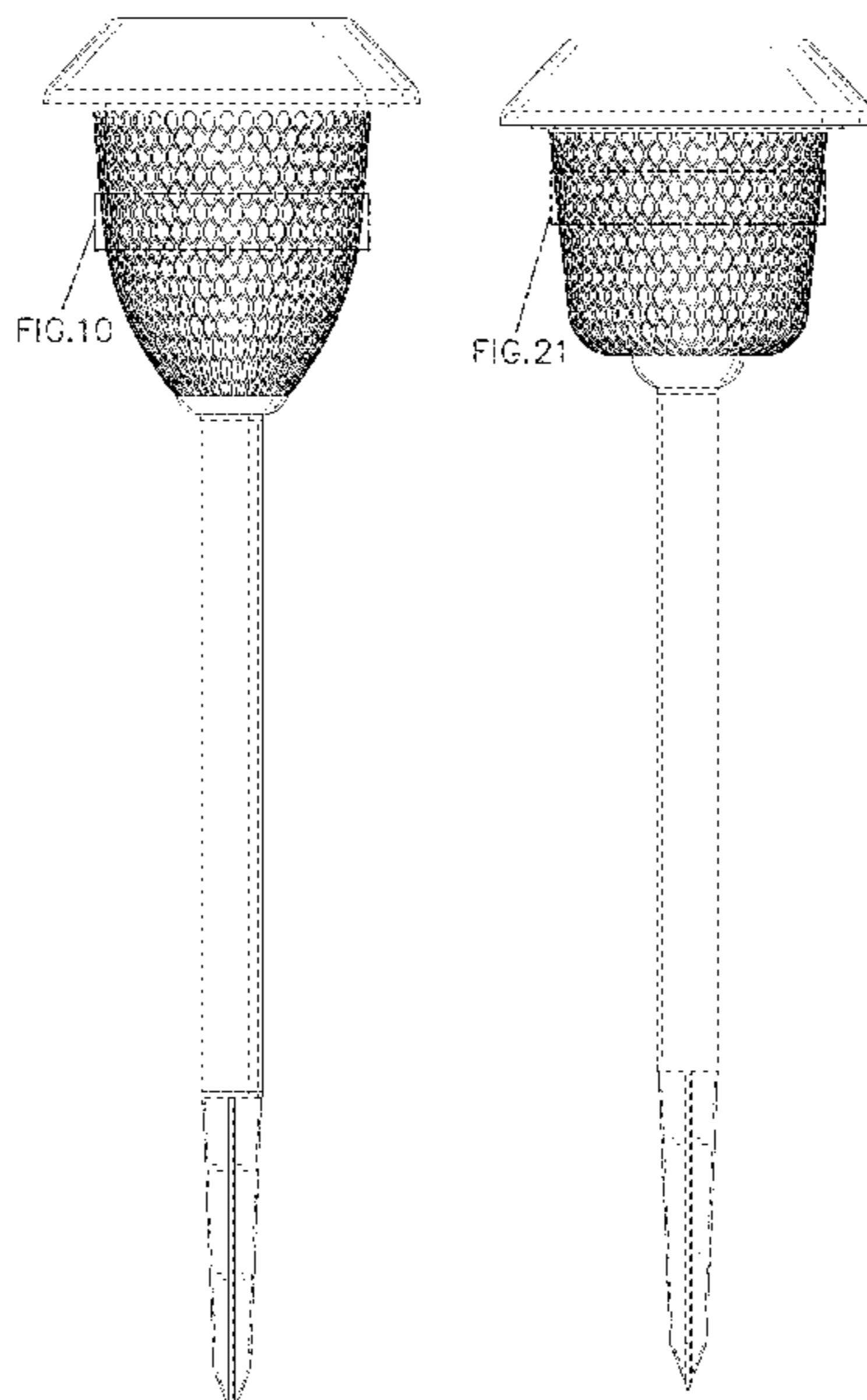

(58) **Field of Classification Search**

CPC F21S 8/006; F21S 8/08; F21S 8/081; F21S
8/083; F21S 8/032; F21S 9/03; F21S
9/032; F21S 9/035; F21S 9/037; F21W
2131/109; F21V 3/00; F21V 3/02; F21V
3/04

See application file for complete search history.

(56) **References Cited**

U.S. PATENT DOCUMENTS

D500,159 S * 12/2004 Chen D26/67
D505,508 S * 5/2005 Chen D26/67
D509,613 S * 9/2005 Sooferian D26/67
D520,170 S * 5/2006 Harbaugh D26/68
D520,171 S * 5/2006 Harbaugh D26/68
D532,141 S * 11/2006 Chen D26/67
D533,293 S * 12/2006 Chen D26/67
D539,957 S * 4/2007 Luo D26/128
D556,931 S * 12/2007 Sooferian D26/68
D559,422 S * 1/2008 Sooferian D26/68
D605,804 S * 12/2009 Chen D26/67
D610,285 S * 2/2010 Sanoner D26/68
D638,970 S * 5/2011 Chen D26/67
D638,971 S * 5/2011 Chen D26/67
D670,017 S * 10/2012 Tortel D26/135
D757,980 S * 5/2016 Sooferian D26/68
D758,633 S * 6/2016 Sooferian D26/68
2005/0135101 A1 * 6/2005 Richmond F21S 9/037
362/276
2012/0069581 A1 * 3/2012 Chen F21V 3/061
362/311.14
2013/0049609 A1 * 2/2013 Browder G09F 27/007
315/159

* cited by examiner

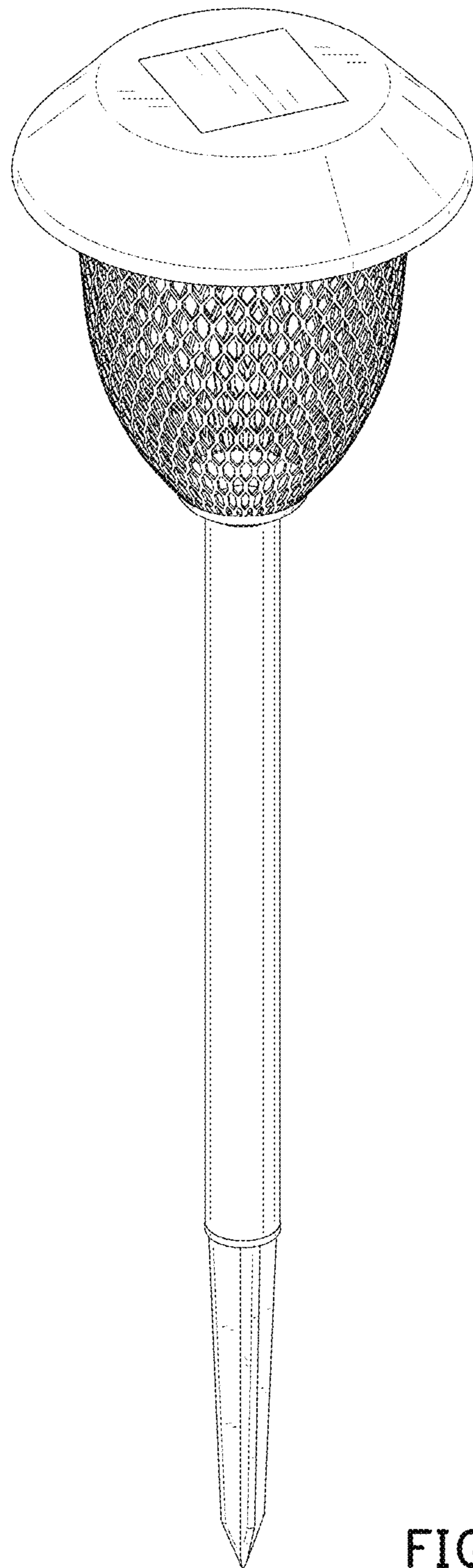

FIG. 1

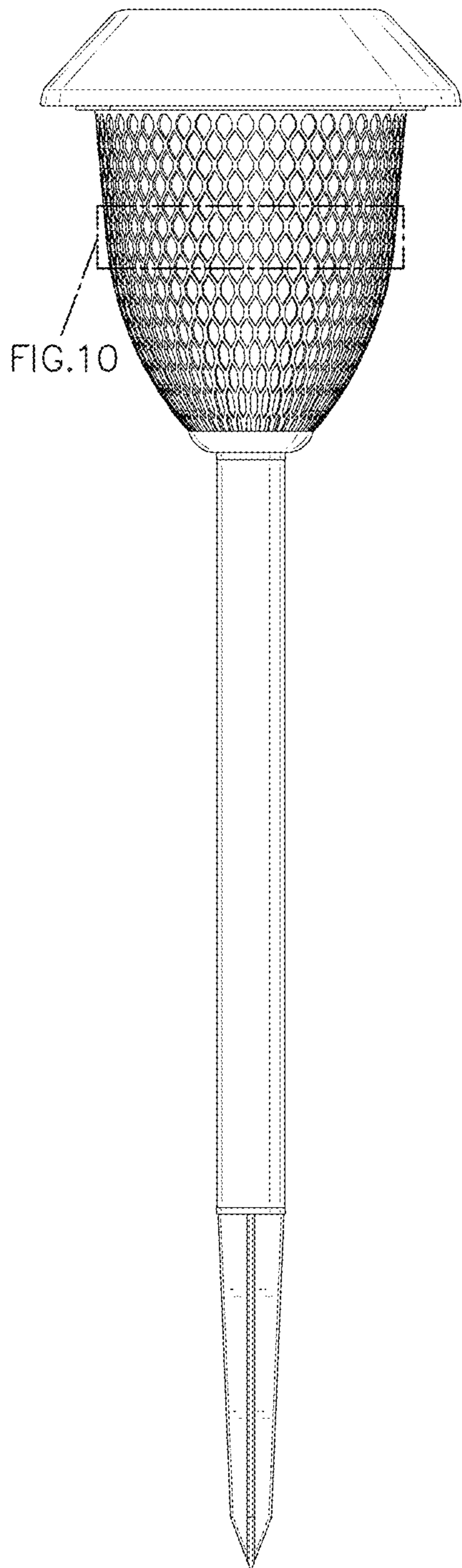

FIG. 2

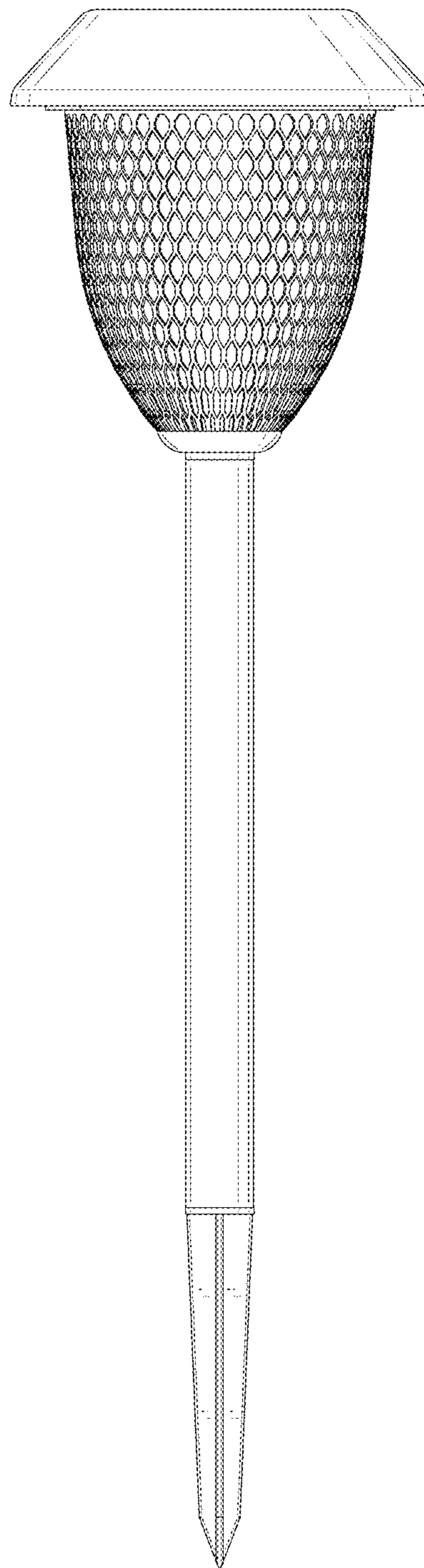

FIG. 3

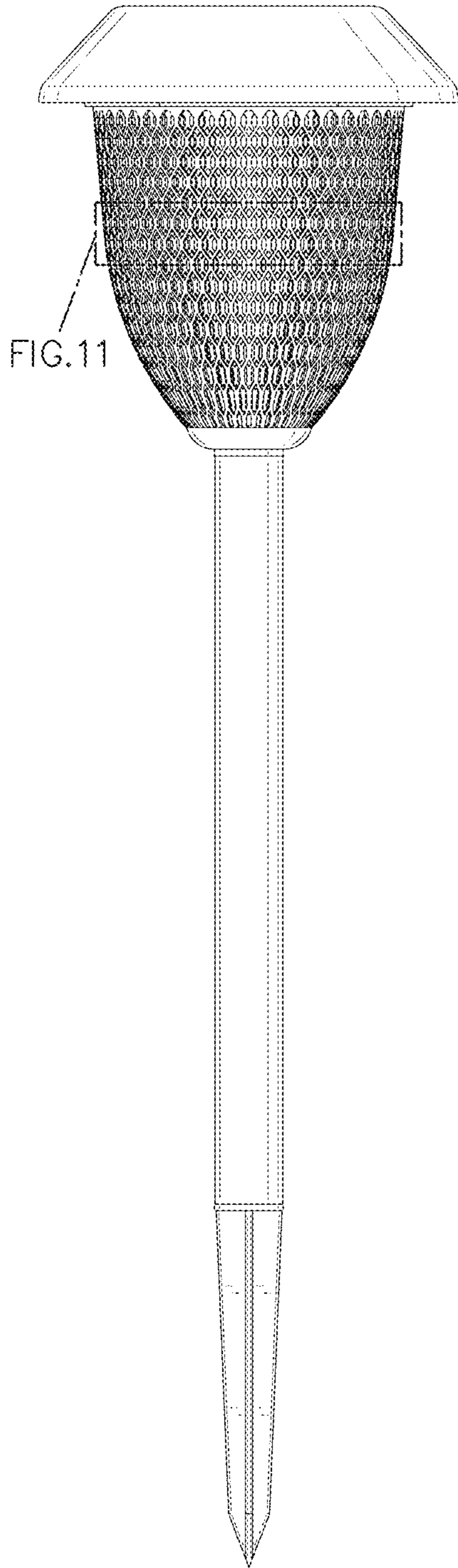

FIG. 4

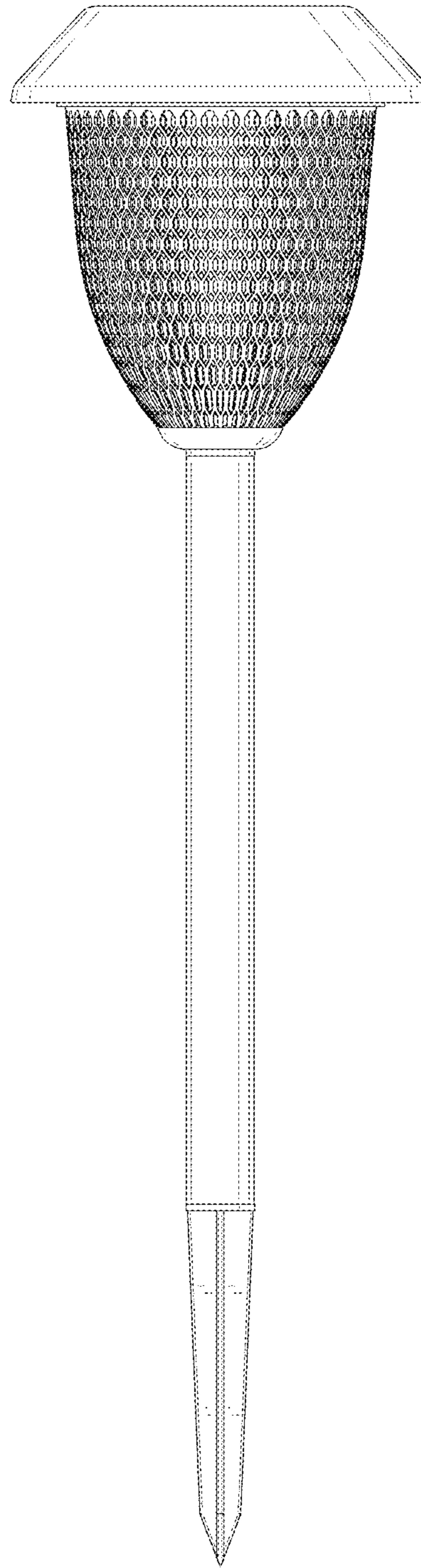

FIG. 5

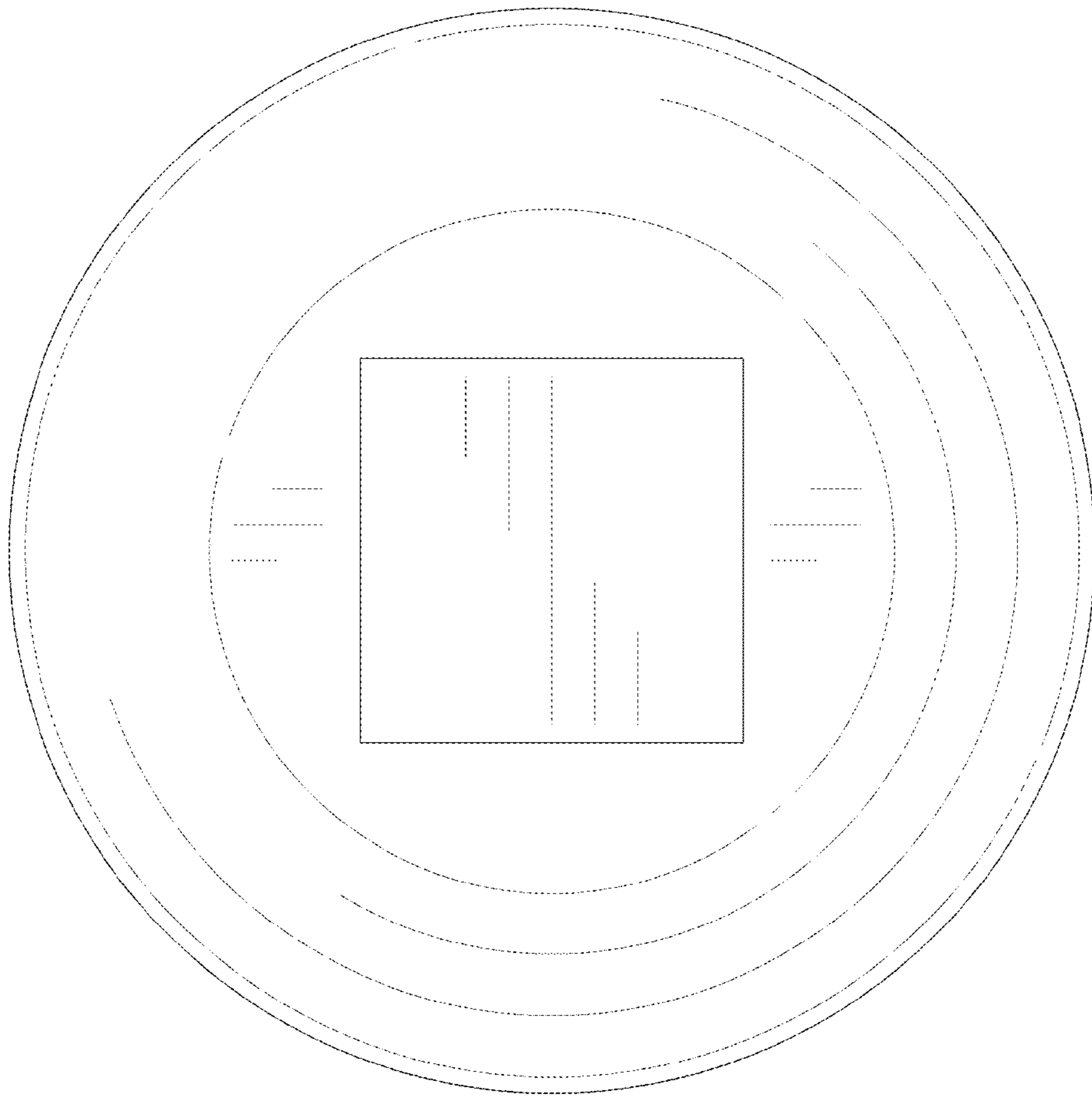

FIG. 6

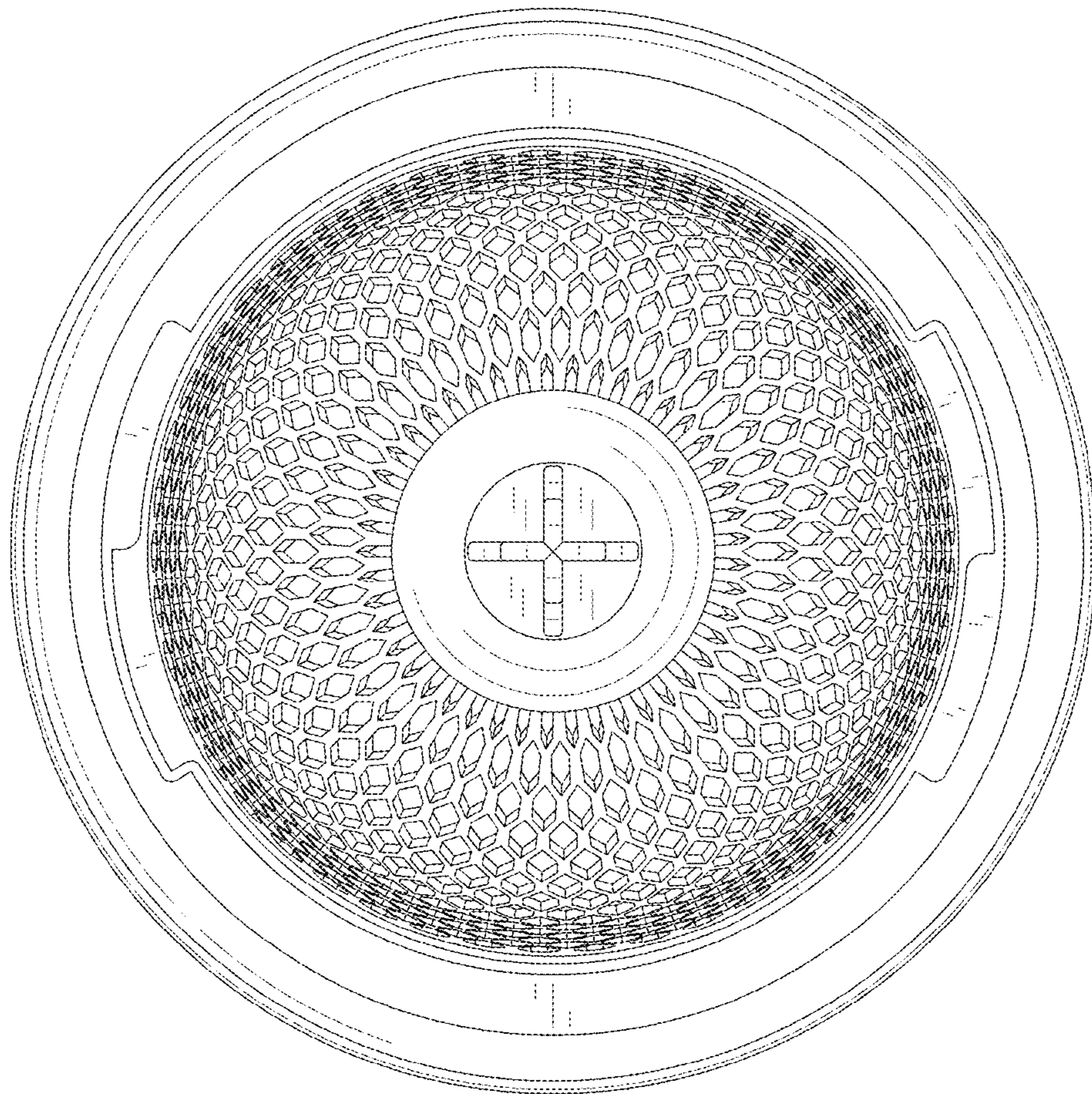

FIG. 7

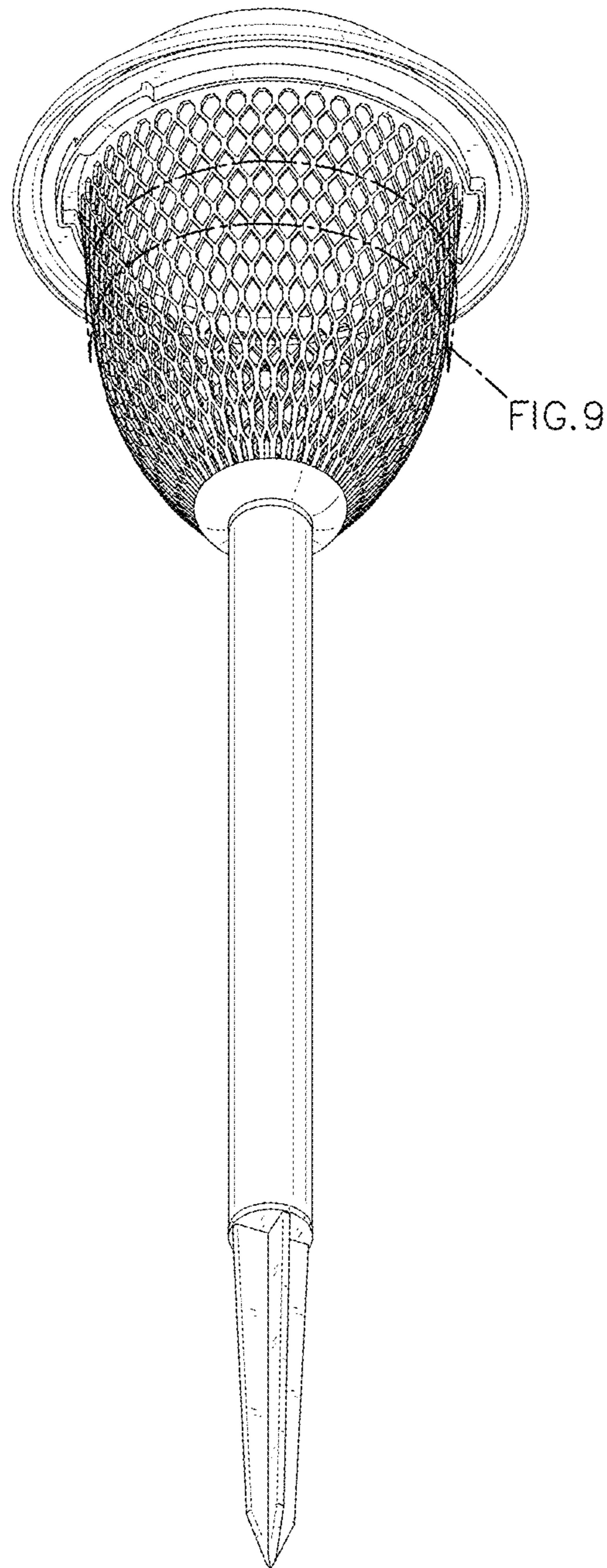

FIG. 8

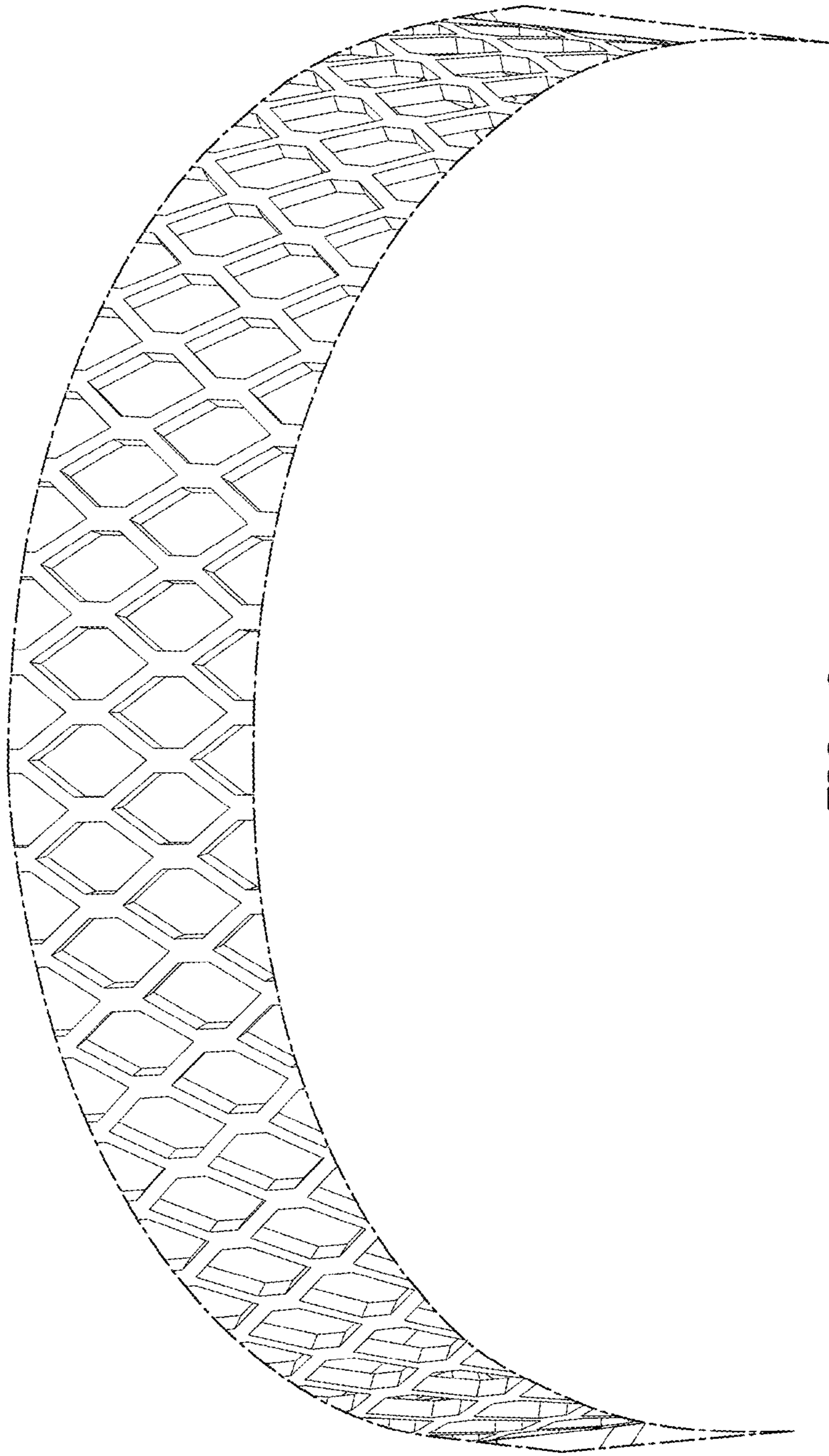

FIG. 9

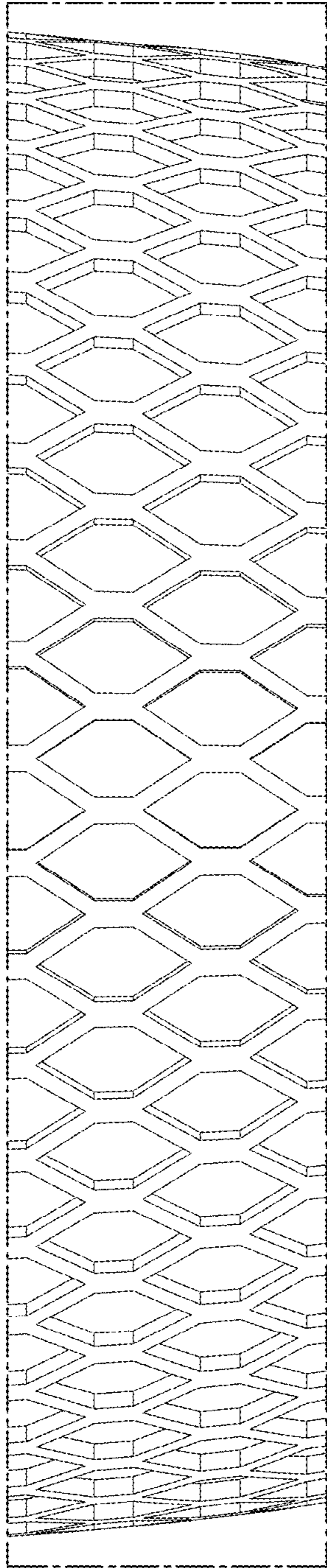

FIG. 10

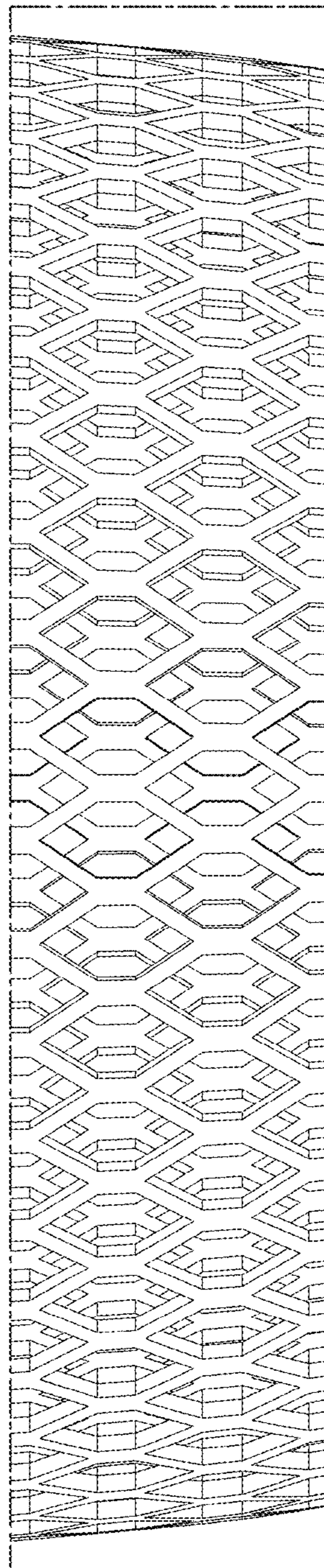

FIG. 11

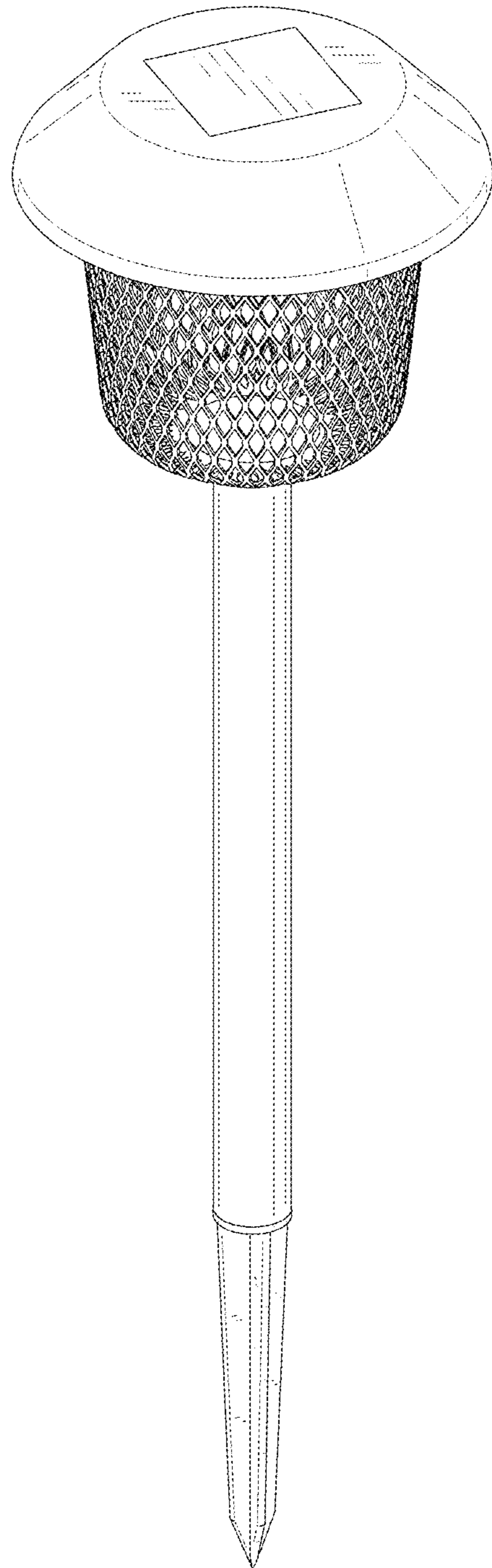

FIG. 12

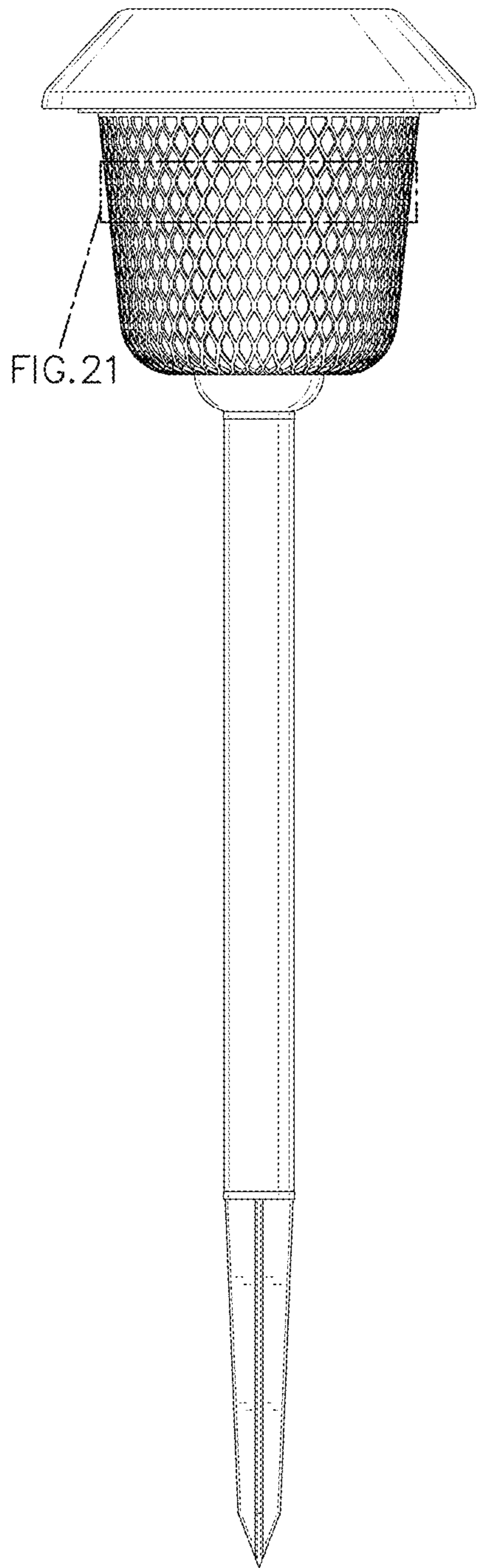

FIG. 13

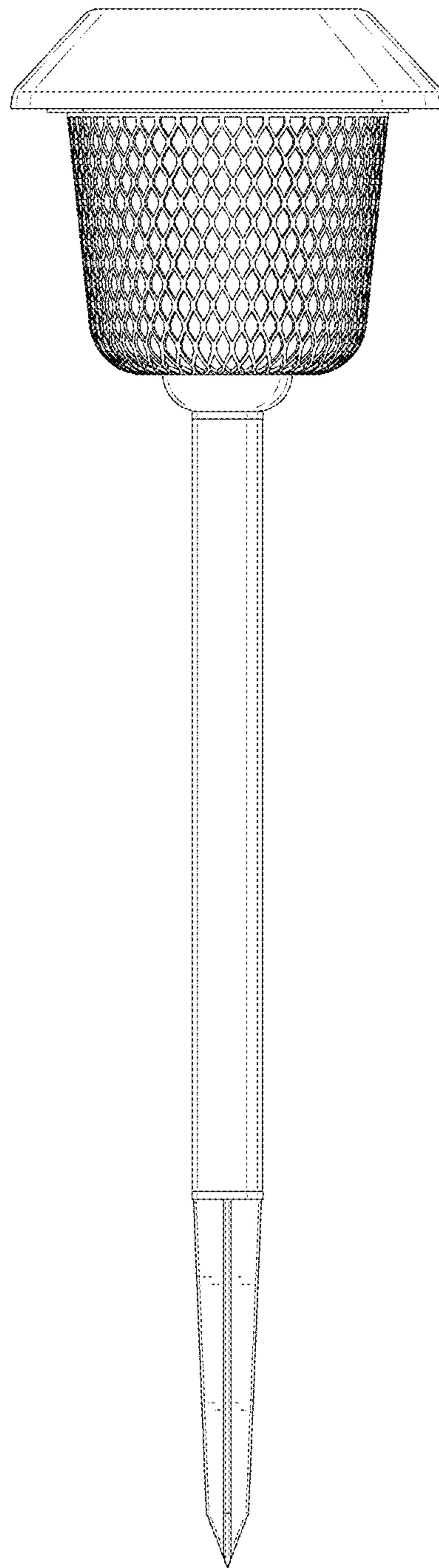

FIG. 14

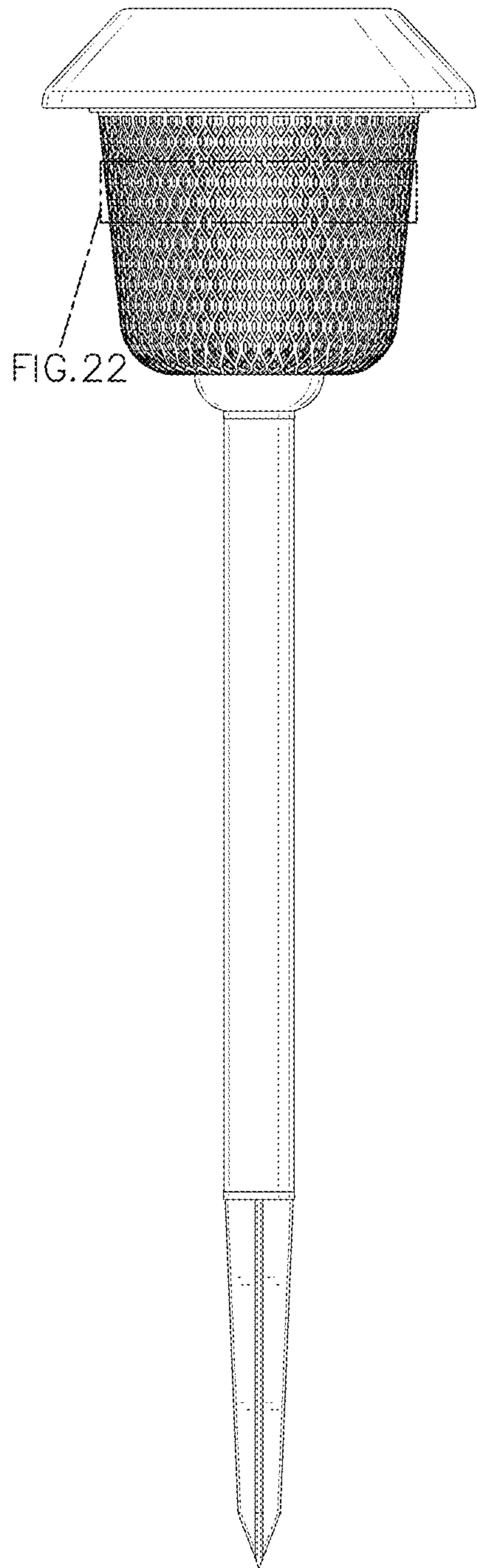

FIG. 15

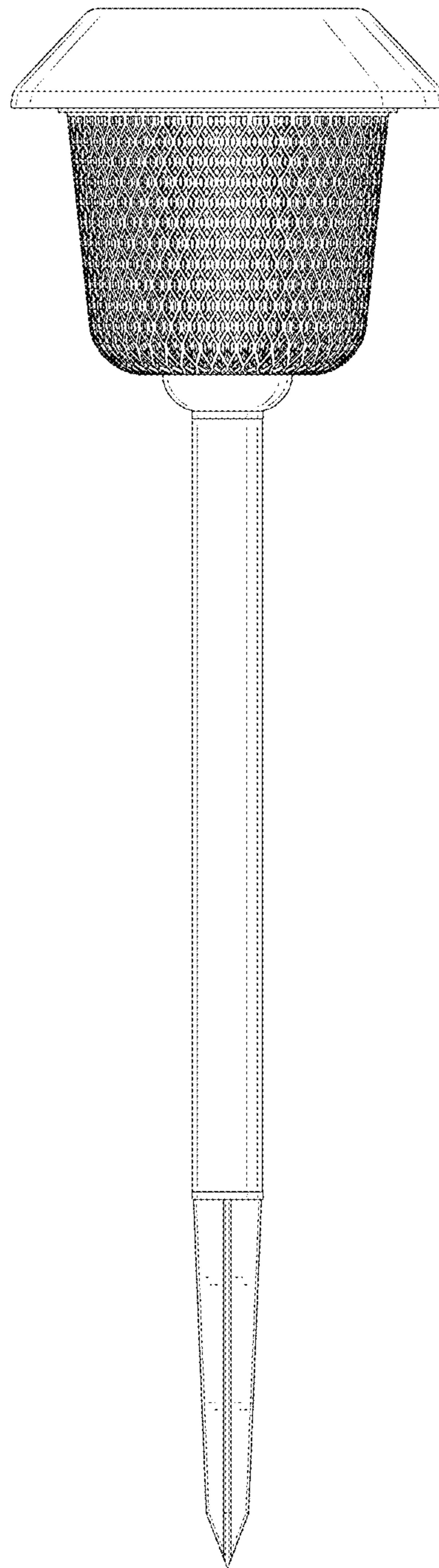

FIG. 16

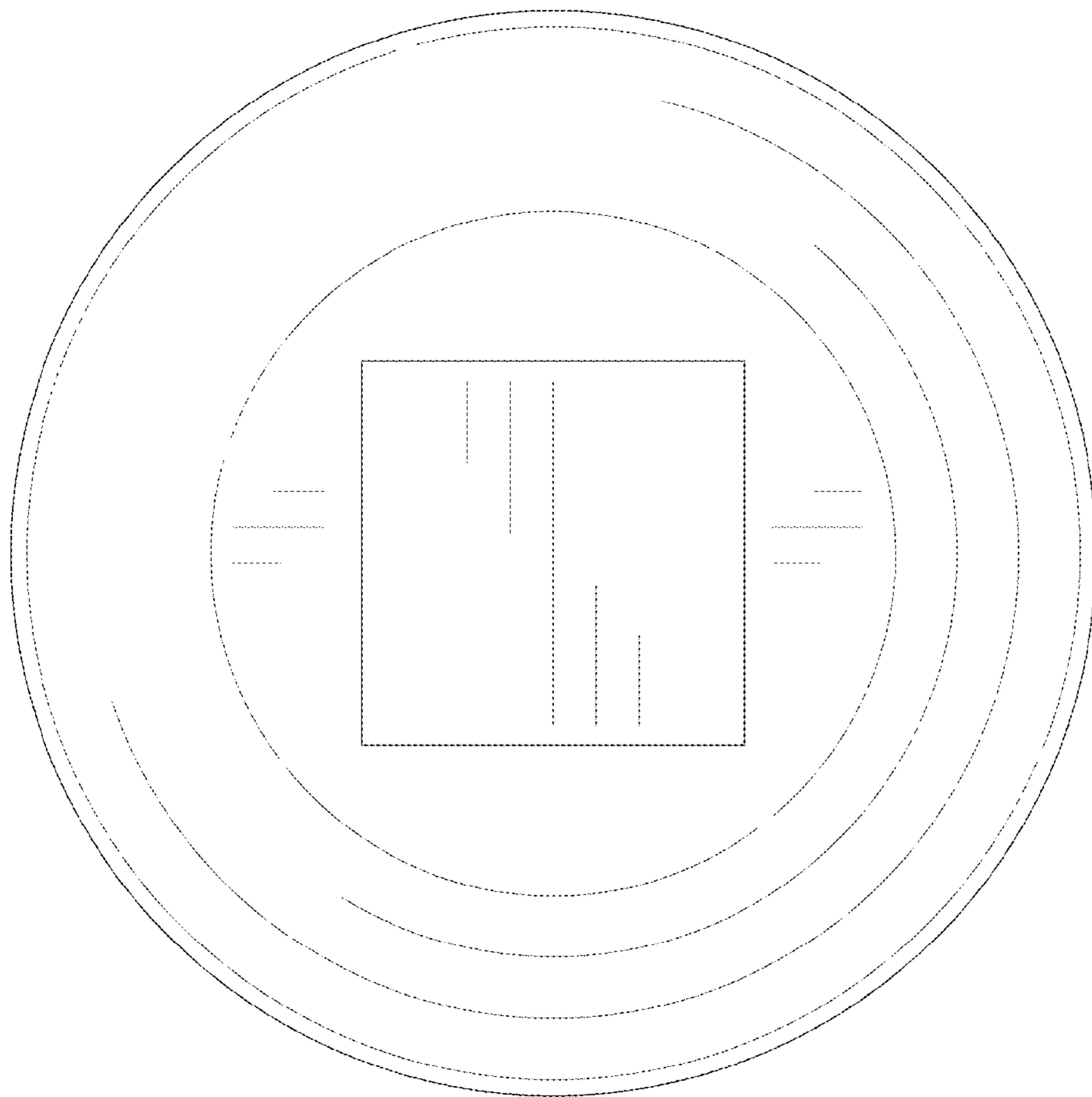

FIG. 17

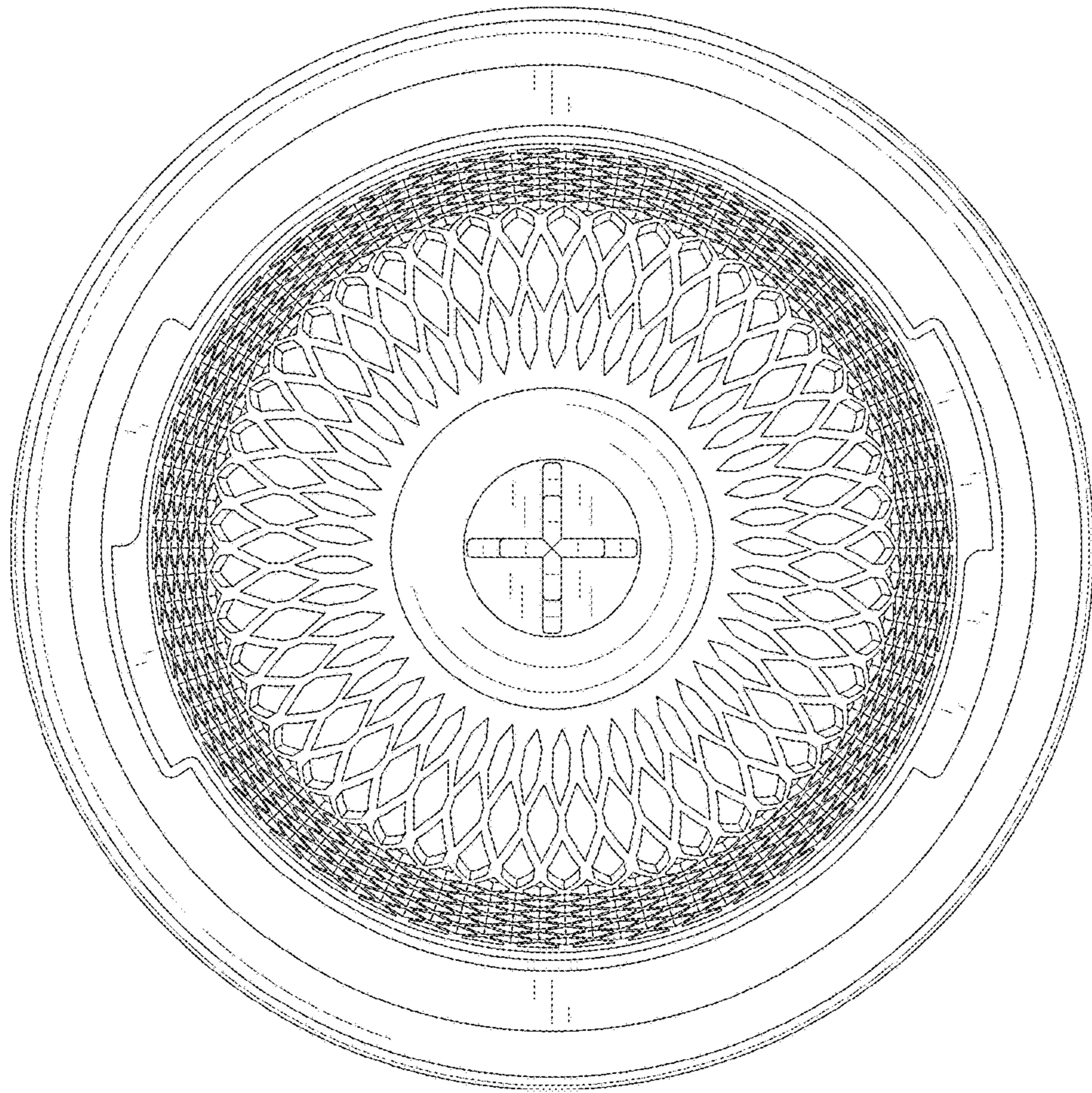

FIG. 18

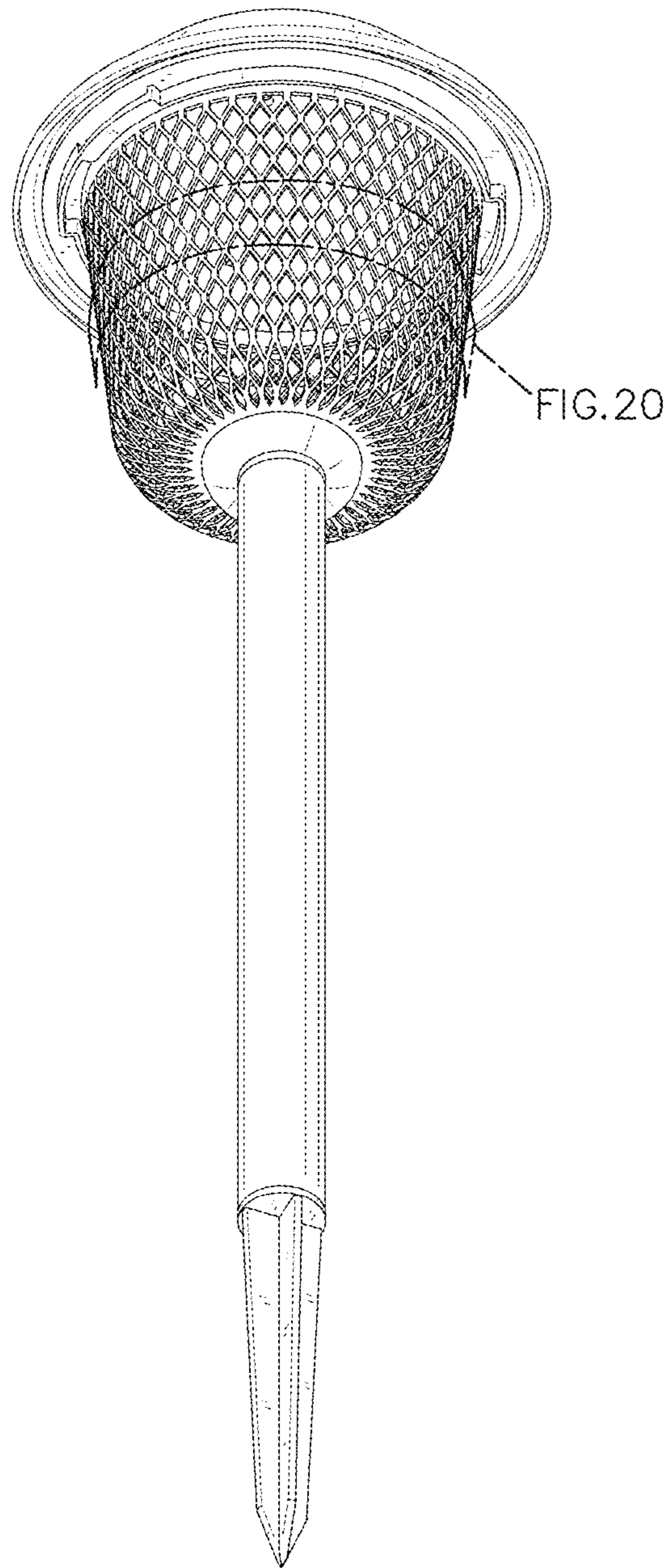

FIG. 19

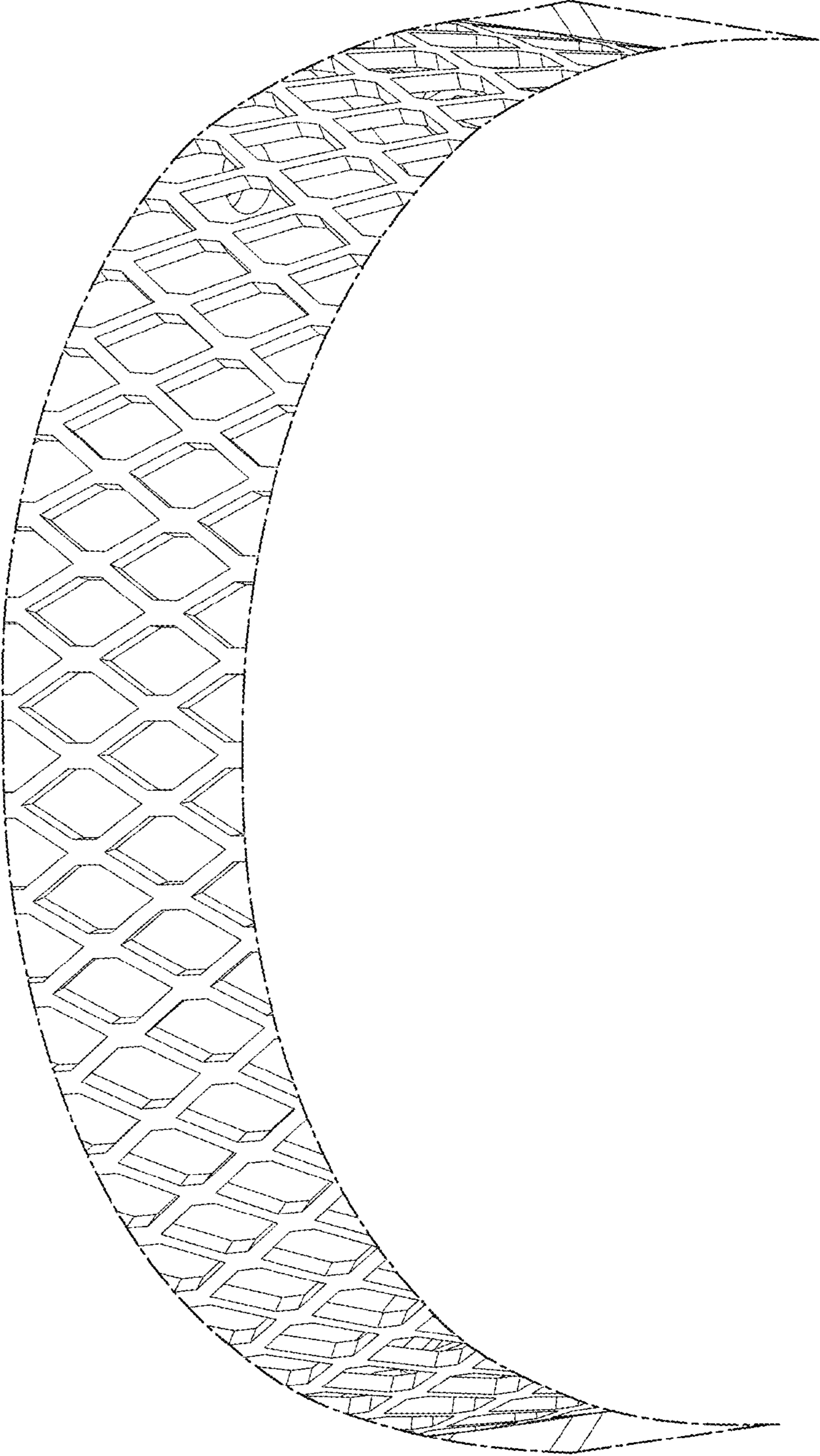

FIG. 20

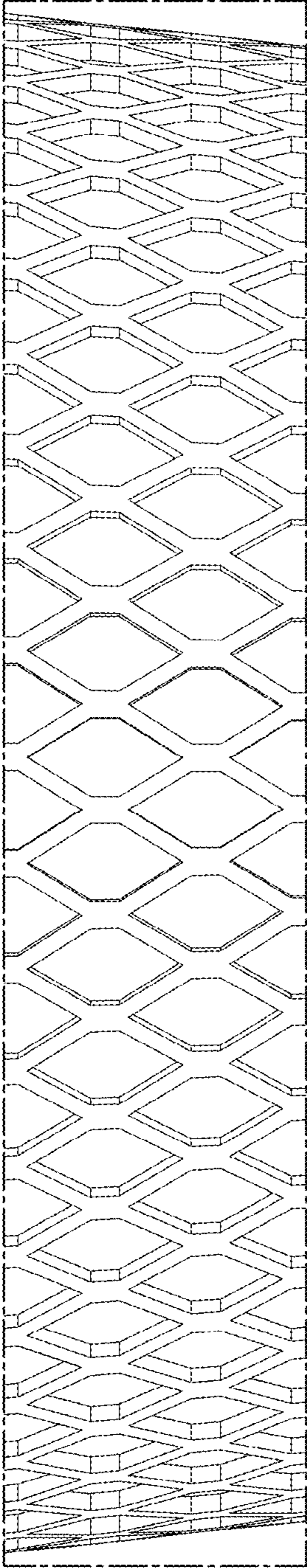

FIG. 21

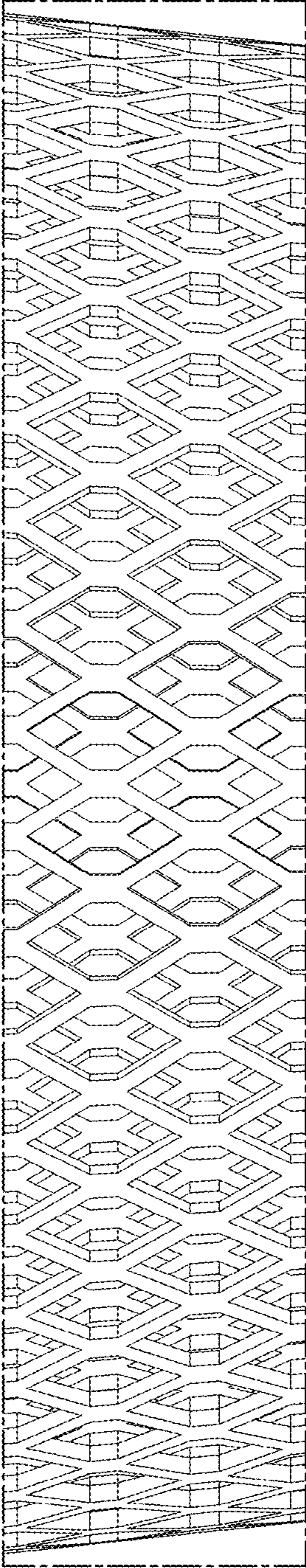

FIG. 22