



US00D861115S

(12) **United States Design Patent**  
**Podgurny**

(10) **Patent No.:** **US D861,115 S**

(45) **Date of Patent:** **\*\* Sep. 24, 2019**

- (54) **LOWER RECEIVER CUT-OUTS**
- (71) Applicant: **F1 Research, LLC—Patents Series,**  
Spring, TX (US)
- (72) Inventor: **Dion Podgurny,** Spring, TX (US)
- (73) Assignee: **F-1 Research LLC—Patent Series,**  
Spring, TX (US)

- D636,832 S \* 4/2011 Mayberry ..... D22/108
- D653,300 S \* 1/2012 Emde ..... D22/103
- D689,974 S \* 9/2013 Sharps ..... D22/108
- D713,485 S \* 9/2014 Firpo, I ..... D22/108
- D726,862 S \* 4/2015 Crume, Sr. .... D22/108
- D726,863 S \* 4/2015 Crume, Sr. .... D22/108
- D729,893 S \* 5/2015 Foster ..... D22/103
- 9,217,618 B1 \* 12/2015 Miller ..... F41A 19/11
- D746,936 S \* 1/2016 Huang ..... D22/108
- D755,338 S \* 5/2016 Slank ..... D22/108

(Continued)

(\*\*) Term: **15 Years**

(21) Appl. No.: **29/637,459**

(22) Filed: **Feb. 19, 2018**

**Related U.S. Application Data**

(63) Continuation-in-part of application No. 29/588,851,  
filed on Dec. 23, 2016, now Pat. No. Des. 835,225.

(51) **LOC (12) Cl.** ..... **22-01**

(52) **U.S. Cl.**  
USPC ..... **D22/108**

(58) **Field of Classification Search**  
USPC ..... D22/108, 100, 101, 103, 105, 109, 110;  
D21/572-575; D14/418, 124, 125, 126,  
D14/127, 128, 10, 83, 85, 86, 87, 90,  
D14/113, 117, 141, 75.01, 75.02, 75.03,  
D14/75.05, 50, 51, 71.01, 94, 106;  
362/110

CPC ..... F41C 7/00; F41C 7/11; F41C 7/12; F41C  
23/10; F41C 23/14; F41C 23/16; F41C  
23/18; F41C 23/00; F41C 27/00; F41C  
27/06; F41A 5/18; F41A 5/24; F41A  
21/28

See application file for complete search history.

(56) **References Cited**

**U.S. PATENT DOCUMENTS**

- D603,011 S \* 10/2009 Fitzpatrick ..... D22/108
- 7,798,045 B1 \* 9/2010 Fitzpatrick ..... F41A 21/481  
42/69.02

**OTHER PUBLICATIONS**

Skeletonized FDR-15 Matched Receiver Set (Billet Like Features),  
F-1Firearms.com, [online], [site visited Mar. 26, 2019]. <URL:  
<https://f-1firearms.com/skeletonized-fdr-15-matched-receiver-set-billet-like-features/>> (Year: 2019).\*

(Continued)

*Primary Examiner* — T Chase Nelson

*Assistant Examiner* — Jonathan J. Han

(74) *Attorney, Agent, or Firm* — Dossey & Jones PLLC;  
Phillip Black; James P. Dossey

(57) **CLAIM**

The ornamental design for lower receiver cut-outs, as shown  
and described.

**DESCRIPTION**

FIG. 1 is an isometric front view showing the right side of  
my design for lower receiver cut-outs;  
FIG. 2 is a right side view thereof;  
FIG. 3 is a top view thereof;  
FIG. 4 is a left side view thereof;  
FIG. 5 is a bottom view thereof;  
FIG. 6 is a front view thereof; and,  
FIG. 7 is a back view thereof.  
The broken lines are used to show unclaimed portions of the  
invention and form no part of the claimed design.

**1 Claim, 3 Drawing Sheets**

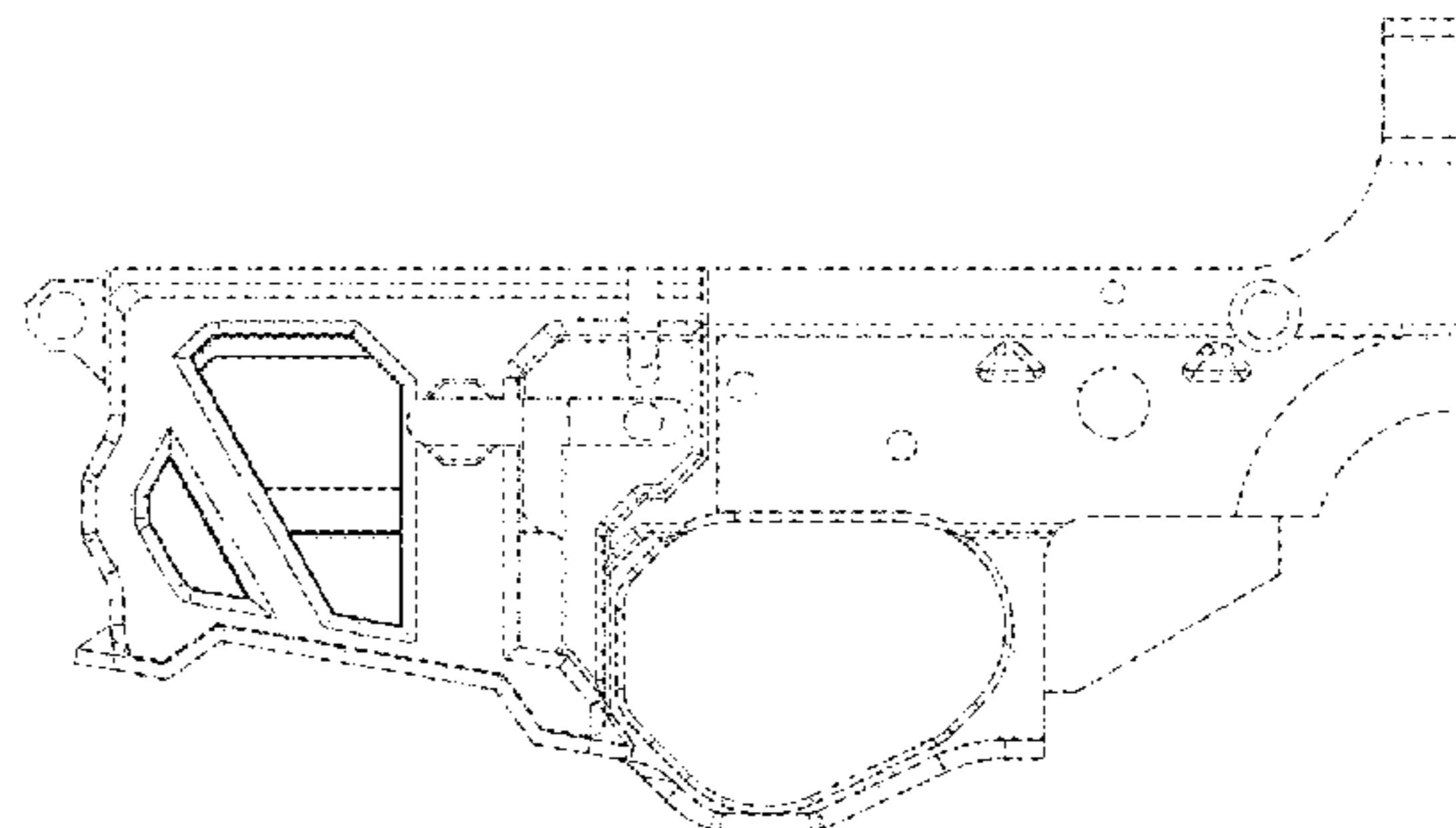
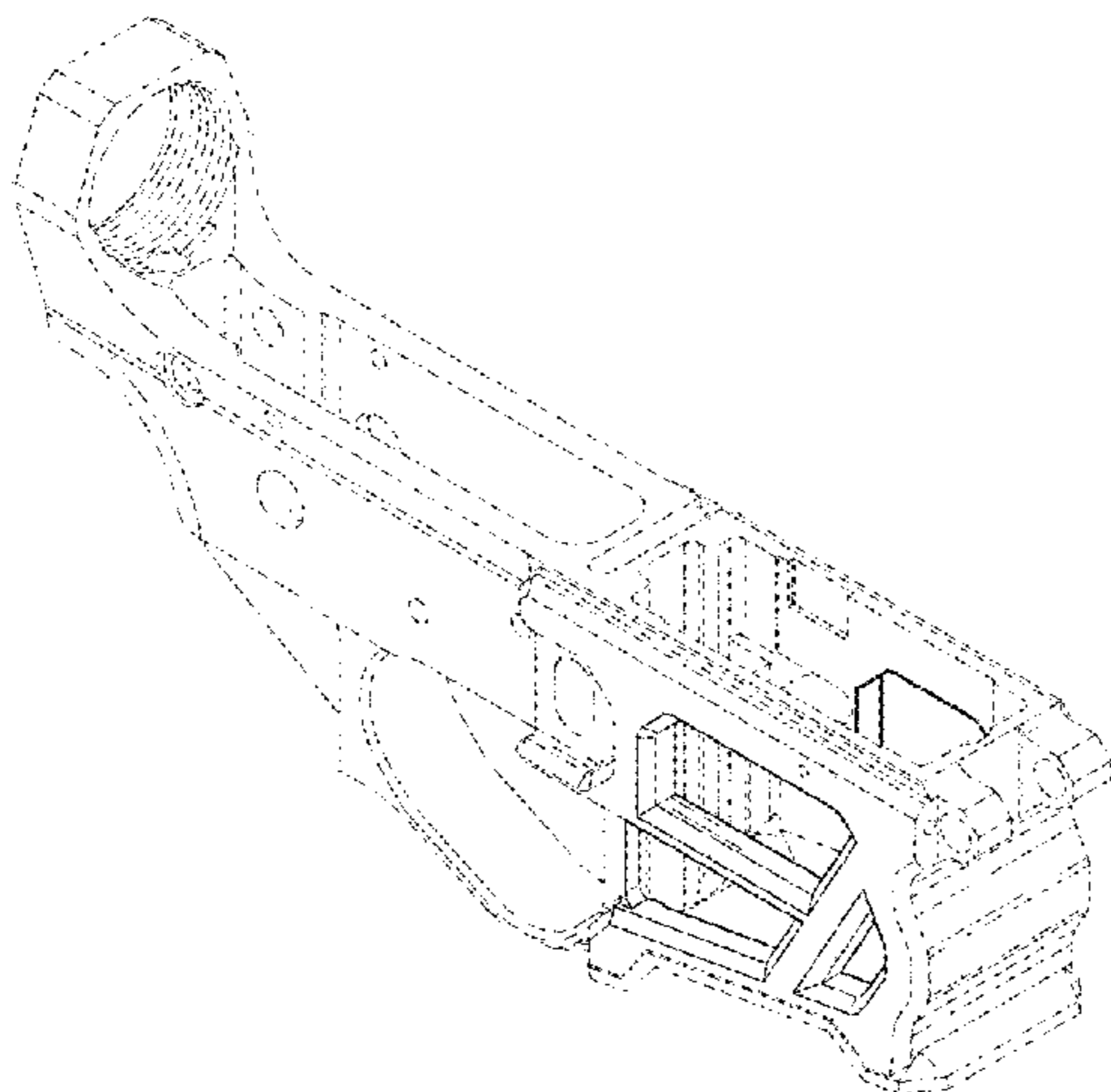

(56)

References Cited

U.S. PATENT DOCUMENTS

D760,860	S	*	7/2016	Vincent	.....	D22/108
D764,005	S	*	8/2016	Neil	.....	D22/108
D765,211	S	*	8/2016	Huang	.....	D22/108
D773,585	S	*	12/2016	Miller, III	.....	D22/108
D776,222	S	*	1/2017	Underwood	.....	F41A 9/59 D22/108
D782,596	S	*	3/2017	Angstadt	.....	D22/108
D785,122	S	*	4/2017	Mather	.....	D22/104
D789,476	S	*	6/2017	Dustin	.....	D22/103
D795,379	S	*	8/2017	Frederickson	.....	D22/108
D795,983	S	*	8/2017	Cross	.....	D22/108
D796,619	S	*	9/2017	Morris	.....	D22/108
D805,154	S	*	12/2017	Steele	.....	D22/108
D820,937	S	*	6/2018	Hiler, Jr.	.....	D22/108
D826,362	S	*	8/2018	Sharps	.....	D22/108
D833,563	S	*	11/2018	Snively	.....	D22/108
D834,112	S	*	11/2018	Chu	.....	D21/573
D835,225	S	*	12/2018	Podgurny	.....	D22/108
D841,109	S	*	2/2019	Cross	.....	D22/108

OTHER PUBLICATIONS

UDP-9 Receiver Set, F-1Firearms.com, [online], [site visited Mar. 26, 2019]. <URL: <https://f-1firearms.com/udp-9-receiver-set/>> (Year: 2019).\*

Best AR-15 Lower Receiver for The Money Reviews, TheGunZone.com, by Norman Turner—Last Updated Mar. 14, 2019, [online], [site visited Mar. 26, 2019]. <URL: <https://thegunzone.com/best-ar-15-lower-receiver-reviews/>> (Year: 2019).\*

Iconic Industries Gen2 Instigator Billet AR-9, .308 DPMS or AR-15 Ultralite 80% Lower Receiver (Options), MSRarms.com, [online], [site visited Mar. 26, 2019]. <URL: <https://msrarms.com/products/iconic-industries-instigator-ultralite/>> (Year: 2019).\*

Lead Star Arms LSA-15-Skeletonized AR-15 Receiver Set-Contrast Cut Black, RainierArms.com, [online], [site visited Mar. 26, 2019]. <URL: <https://www.rainierarms.com/lead-star-arms-lsa-15-skeletonized-ar-15-receiver-set-contrast-cut-black/>> (Year: 2019).\*

\* cited by examiner

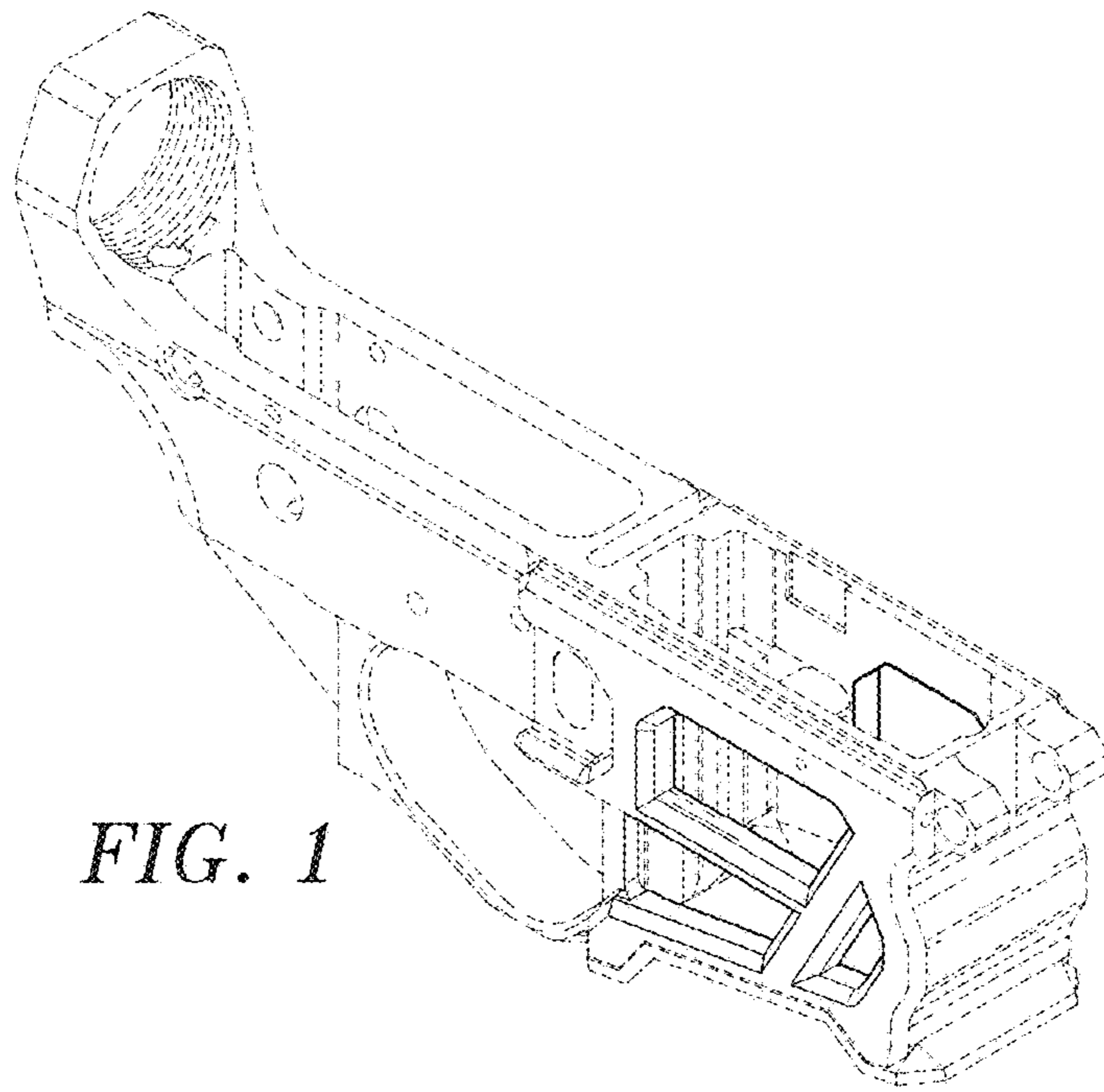

*FIG. 1*

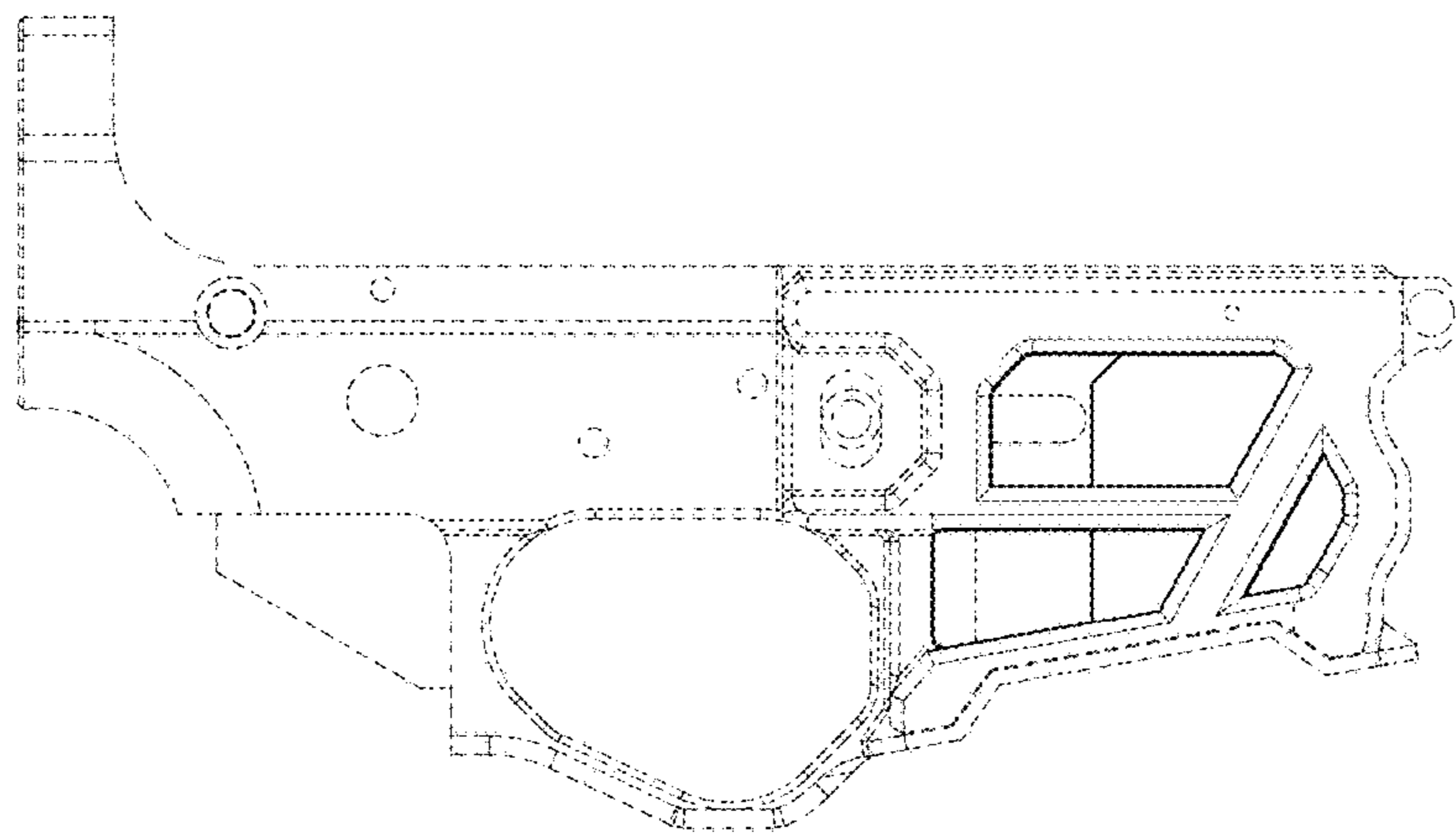

*FIG. 2*

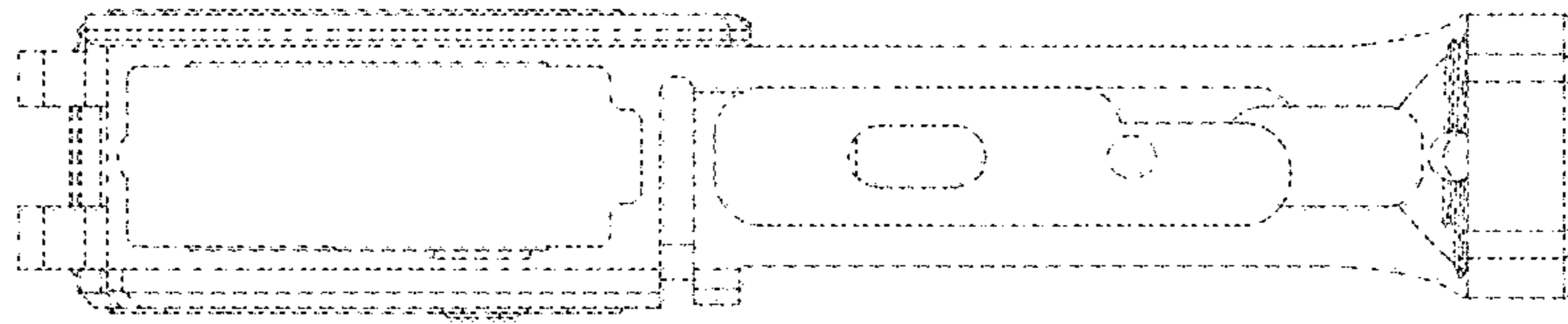

*FIG. 3*

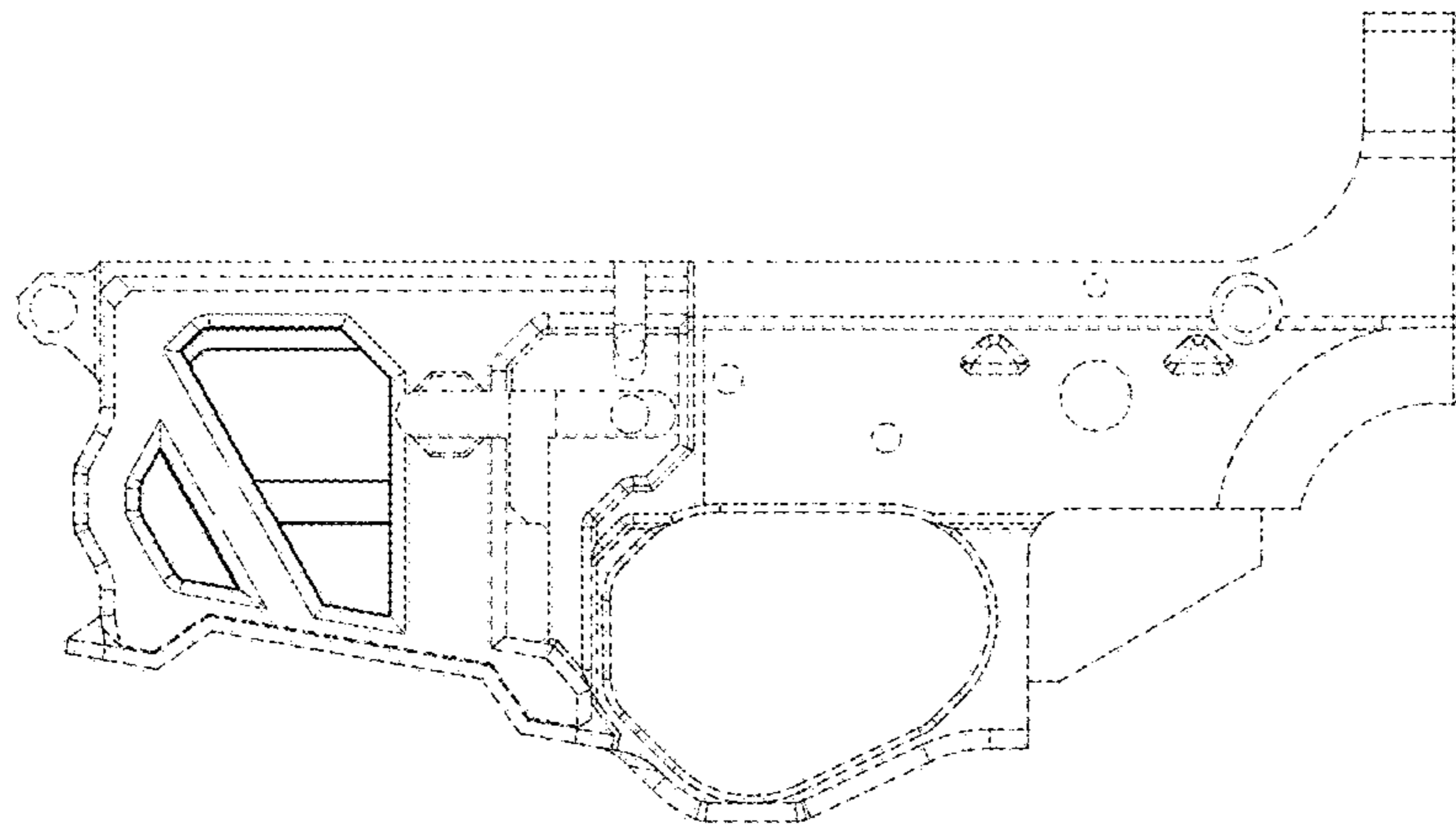

*FIG. 4*

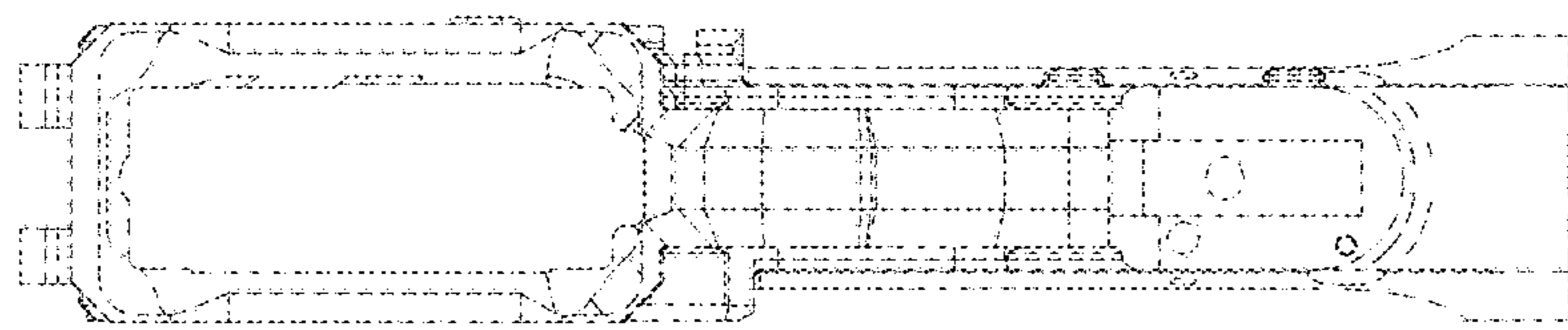

*FIG. 5*

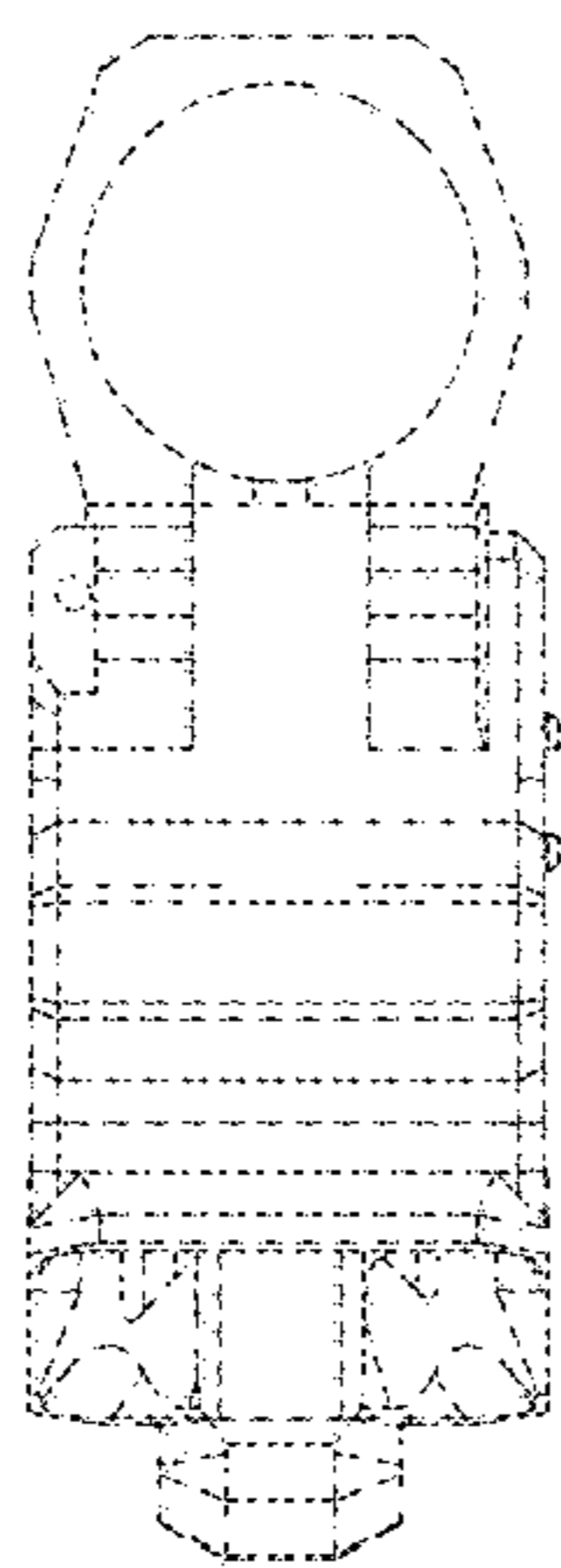

*FIG. 6*

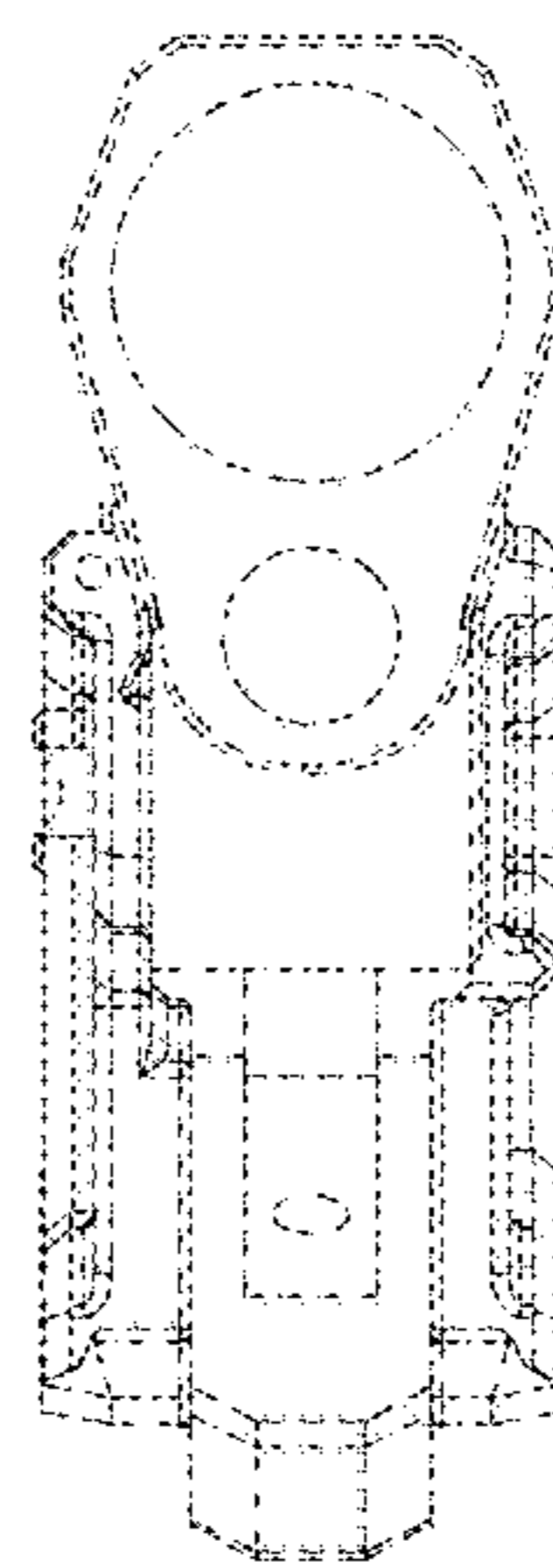

*FIG. 7*