

US00D860975S

(12) **United States Design Patent** (10) **Patent No.:** **US D860,975 S**
Briggs et al. (45) **Date of Patent:** **** Sep. 24, 2019**

- (54) **EARPHONE**
- (71) Applicant: **New Audio LLC**, New York, NY (US)
- (72) Inventors: **Drew Stone Briggs**, Brooklyn, NY (US); **Nicholas Slaney**, Jersey City, NJ (US); **Thomas C. Wilson**, Brooklyn, NY (US); **Marten Wallby**, Malmo (SE)
- (73) Assignee: **New Audio LLC**, New York, NY (US)
- (**) Term: **15 Years**
- (21) Appl. No.: **29/632,542**
- (22) Filed: **Jan. 8, 2018**
- (51) **LOC (12) Cl.** **14-01**
- (52) **U.S. Cl.**
USPC **D14/223**
- (58) **Field of Classification Search**
USPC ... D14/205, 217, 221, 223, 224, 224.1, 225;
D24/173, 174
CPC H04R 1/10; H04R 1/1016; H04R 1/1066;
H04R 1/105; H04R 1/1033; H04R 1/08;
H04R 5/033; H04R 5/0335; H04R 25/00
See application file for complete search history.

- (56) **References Cited**
U.S. PATENT DOCUMENTS
D208,784 S * 10/1967 Sanzone D24/174
D568,302 S * 5/2008 Oh D14/223
D719,549 S * 12/2014 Henry D14/223
D728,107 S * 4/2015 Torres Martin D24/174
D745,862 S * 12/2015 Otani D14/223
D755,158 S * 5/2016 Lee D14/205
D801,950 S * 11/2017 Otani D14/223
D813,205 S * 3/2018 Palmborg D14/223
D817,309 S * 5/2018 Czaniecki D14/223
D818,989 S * 5/2018 Silva D14/205

- D822,646 S * 7/2018 Dang D14/223
- D823,835 S * 7/2018 Loermann D14/223
- D824,371 S * 7/2018 Loermann D14/223
- 2018/0221209 A1 * 8/2018 Ogut A61F 11/08

OTHER PUBLICATIONS

True Wireless Earphones, posted © 2018 [online], retrieved Dec. 6, 2018, retrieved from internet, <<https://www.masterdynamic.com/products/mw07-true-wireless-earphones>>.*
 MW07_SKU_TS_15, posted Sep. 11, 2018 0:04 [online], retrieved Dec. 6, 2018, retrieved from internet, <<https://www.youtube.com/watch?v=UKkBh3XIIQk&feature=youtu.be>>.*
 Master & Dynamic MW07 True Wireless Earphones, posted Sep. 19, 2018 [online], retrieved Dec. 6, 2018, retrieved from internet, <<https://www.amazon.com/Master-Dynamic-Earphones-Connectivity-Tortoiseshell/dp/B07H8S4N36>>.*

* cited by examiner

Primary Examiner — Barbara Fox
Assistant Examiner — Messina L Smith
 (74) *Attorney, Agent, or Firm* — Perkins Coie LLP

(57) **CLAIM**

The ornamental design for an earphone, as shown and described.

DESCRIPTION

FIG. 1 is a perspective view of an earphone showing our design, as viewed from the top and front.
 FIG. 2 is a perspective view thereof, as viewed from the bottom and back.
 FIG. 3 is an outer side elevation view thereof.
 FIG. 4 is an inner side elevation view thereof.
 FIG. 5 is a front elevation view thereof.
 FIG. 6 is a back elevation view thereof.
 FIG. 7 is a top plan view thereof; and,
 FIG. 8 is a bottom plan view thereof.

1 Claim, 4 Drawing Sheets

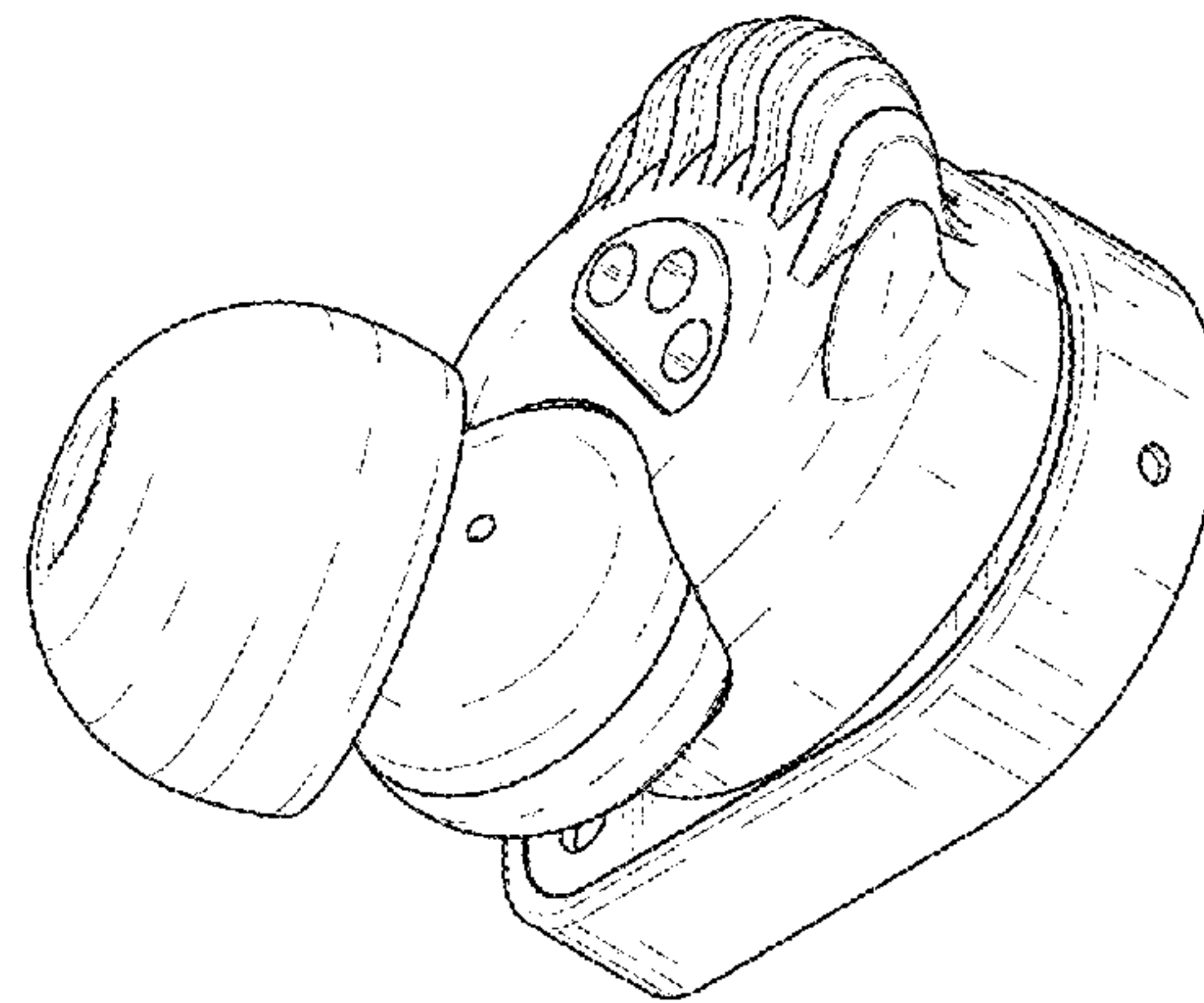
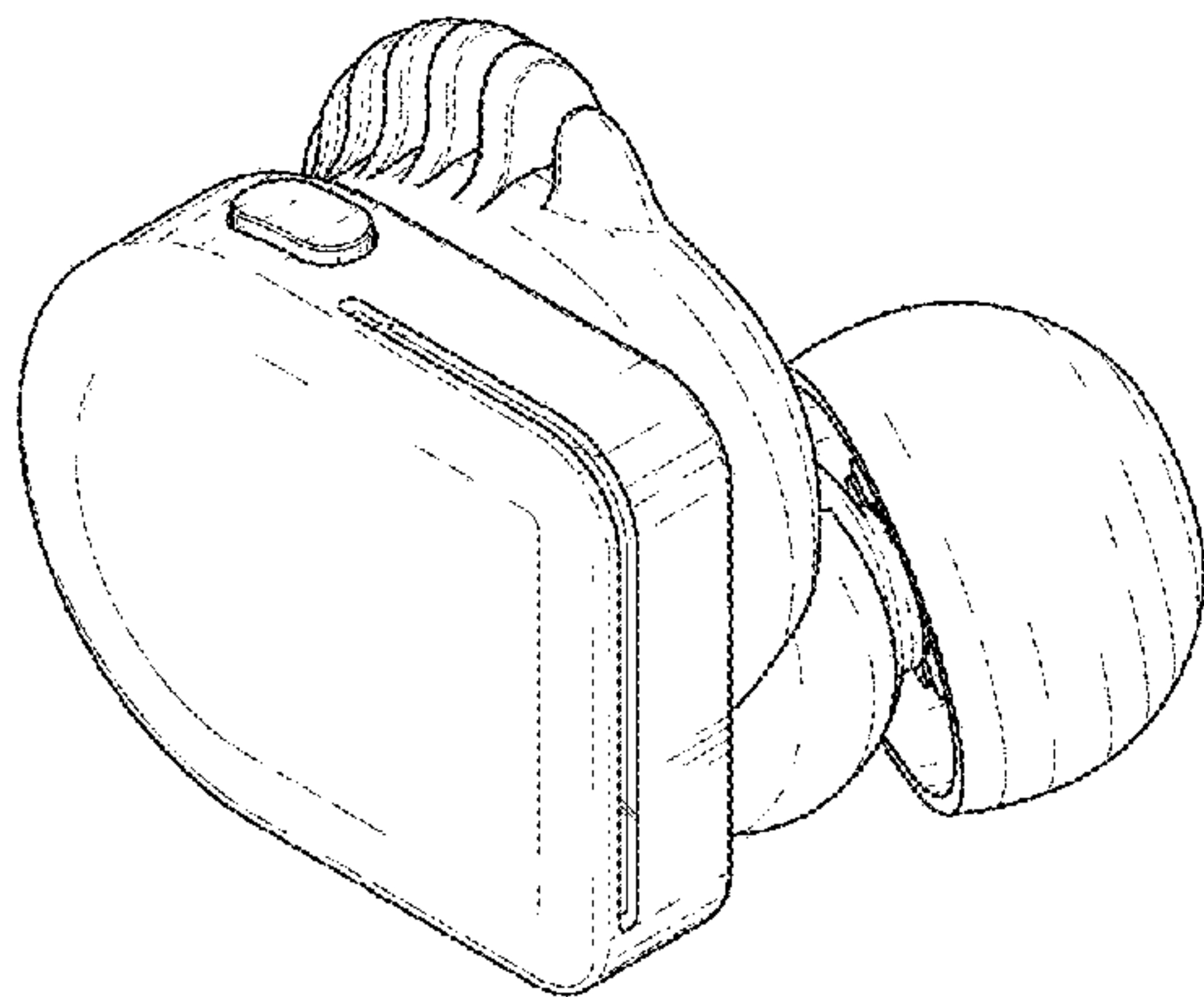

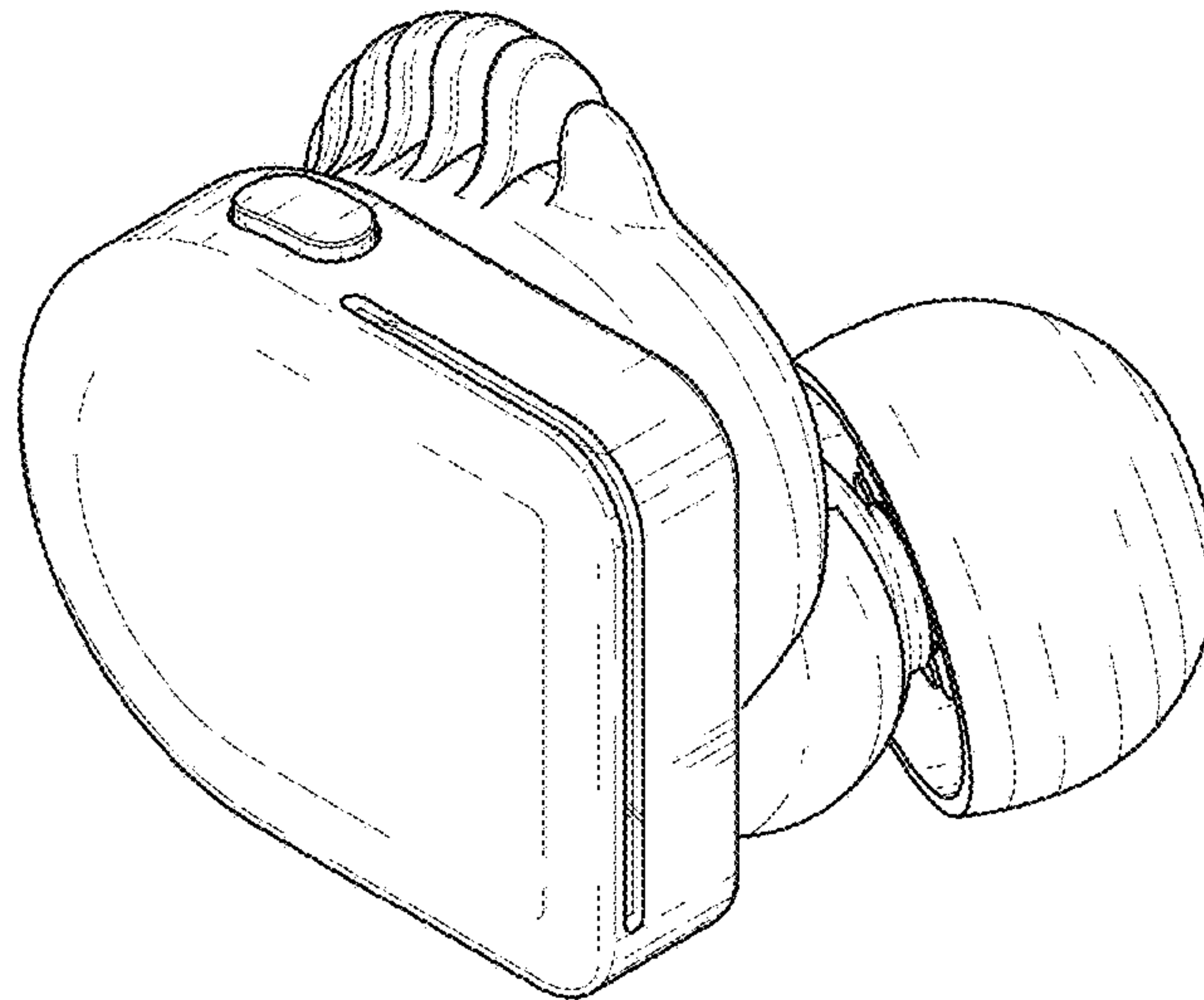

Fig. 1

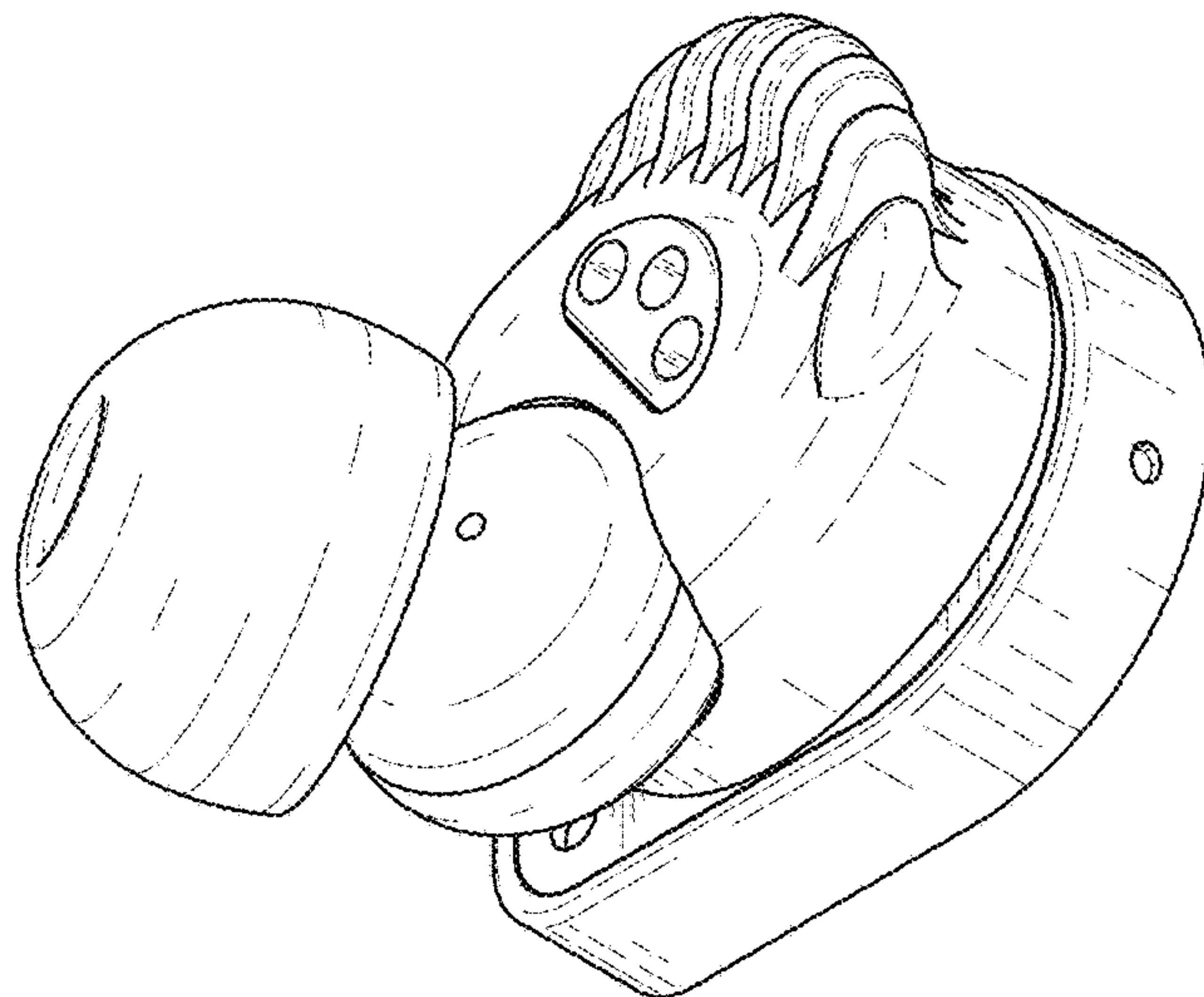

Fig. 2

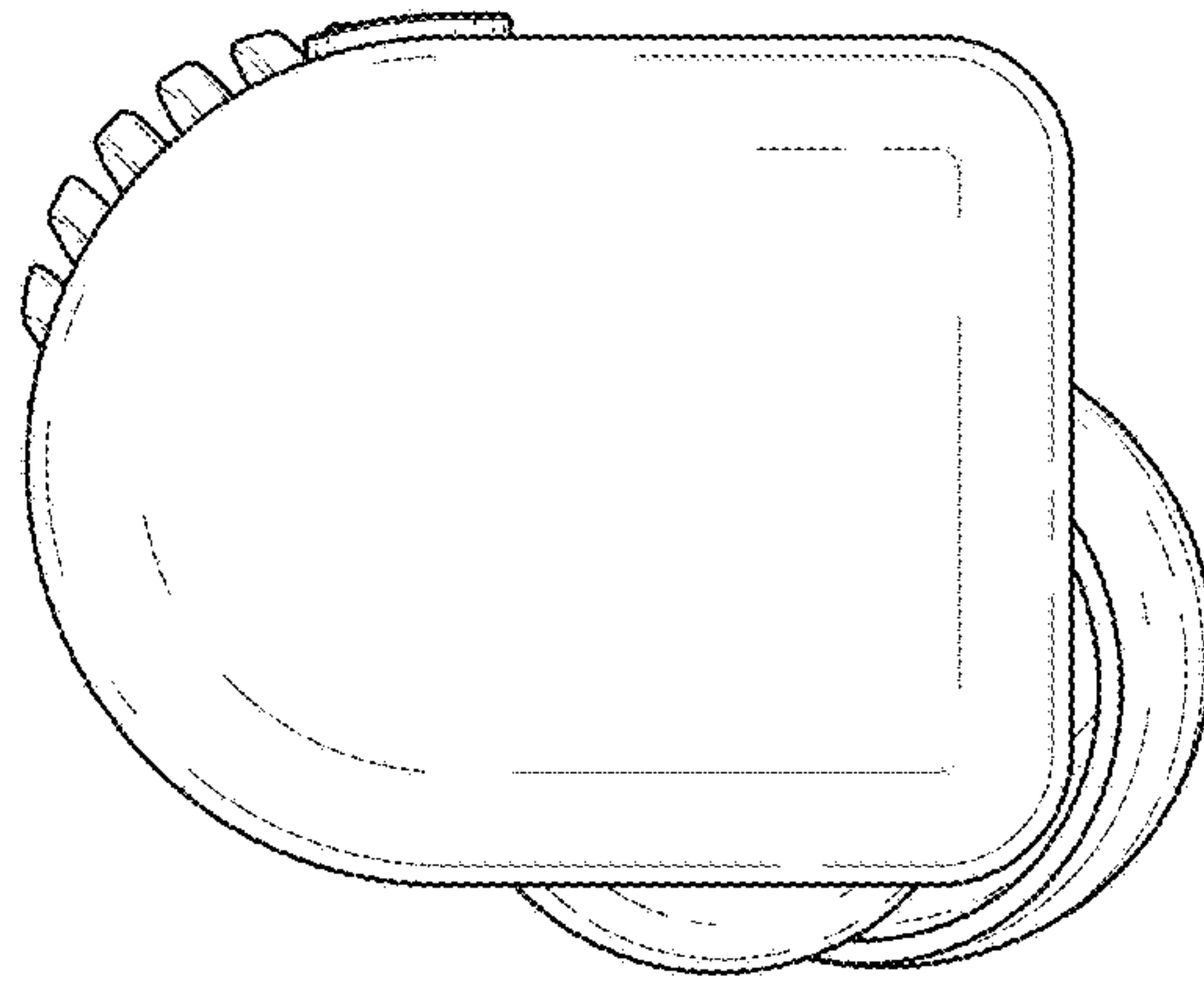

Fig. 3

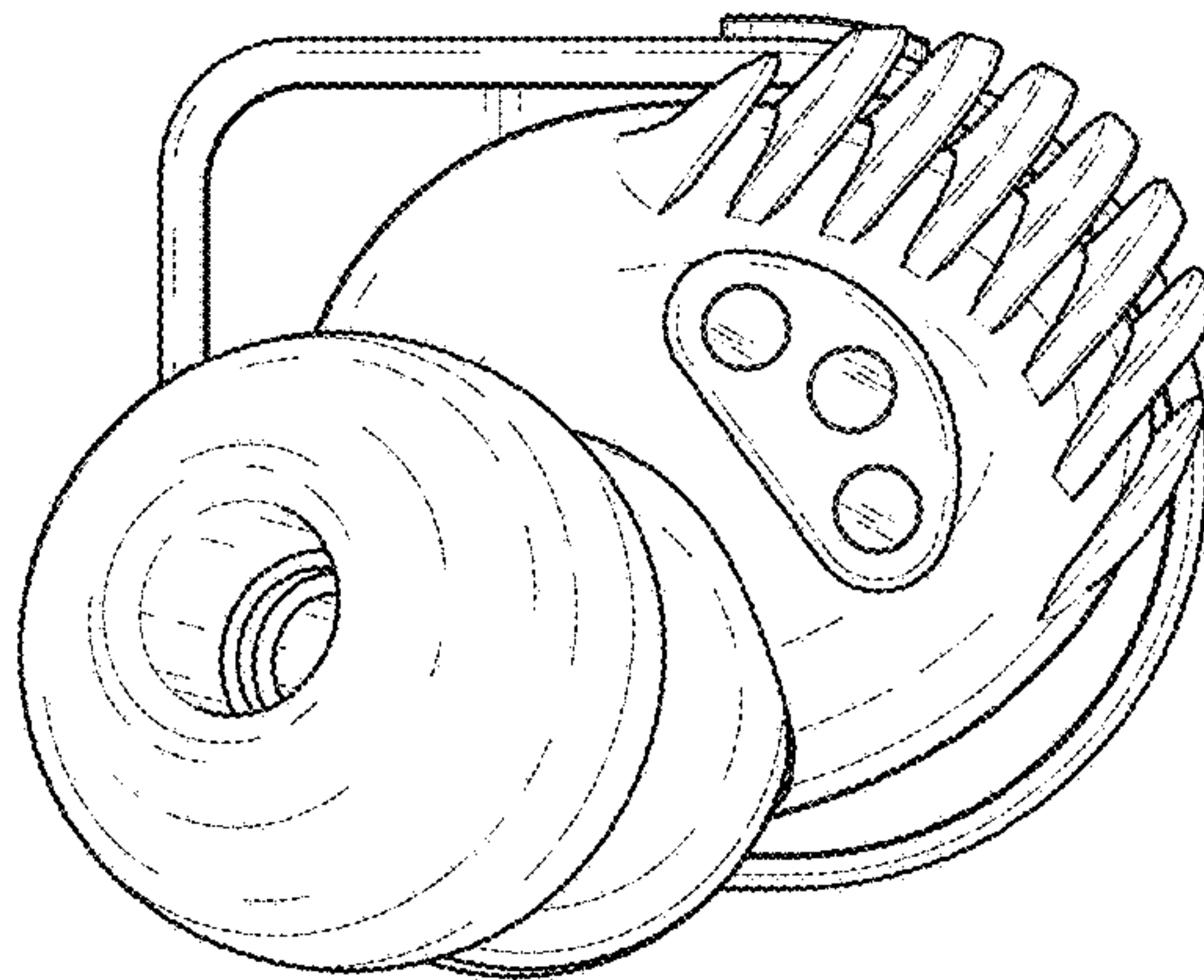

Fig. 4

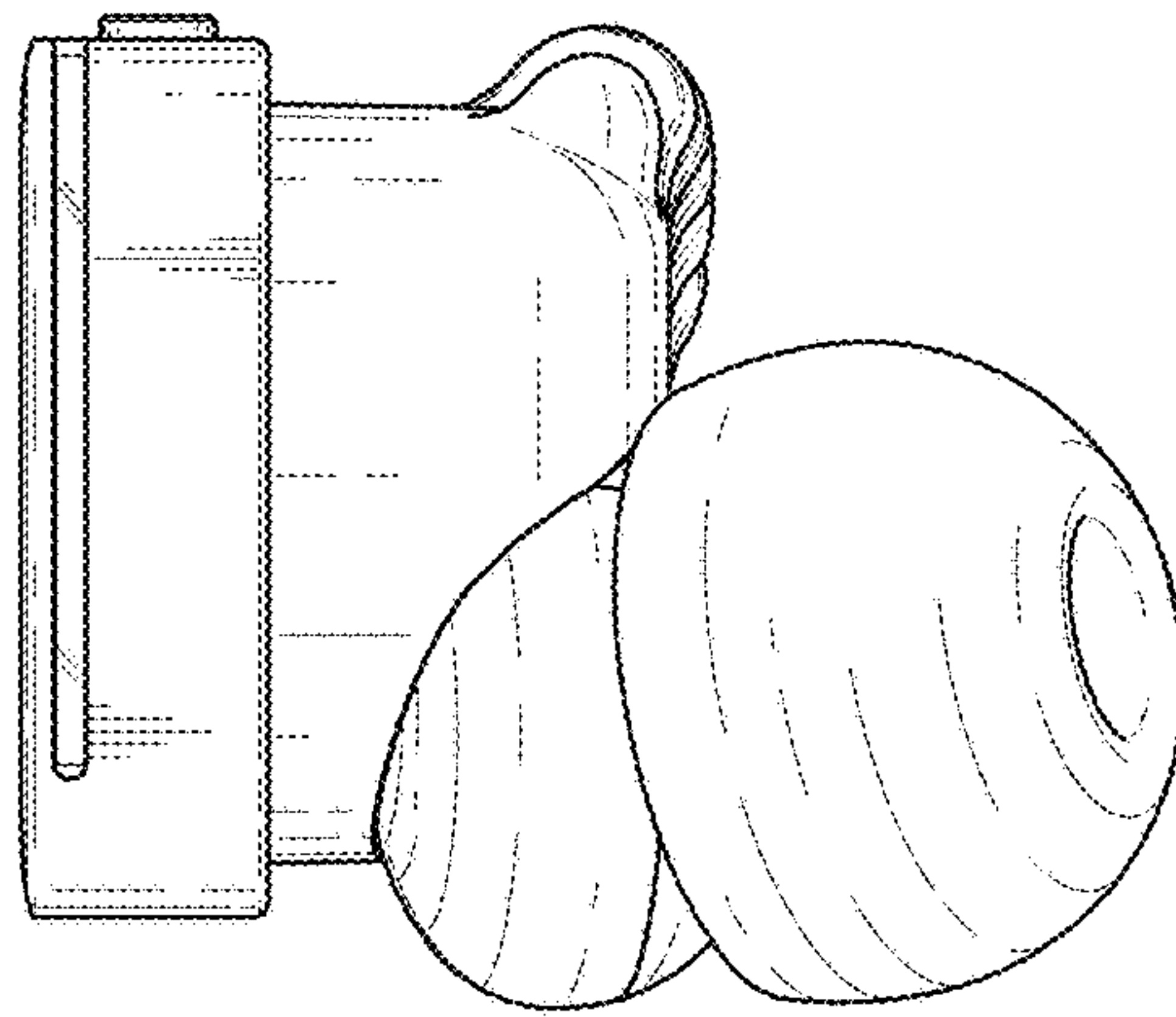

Fig. 5

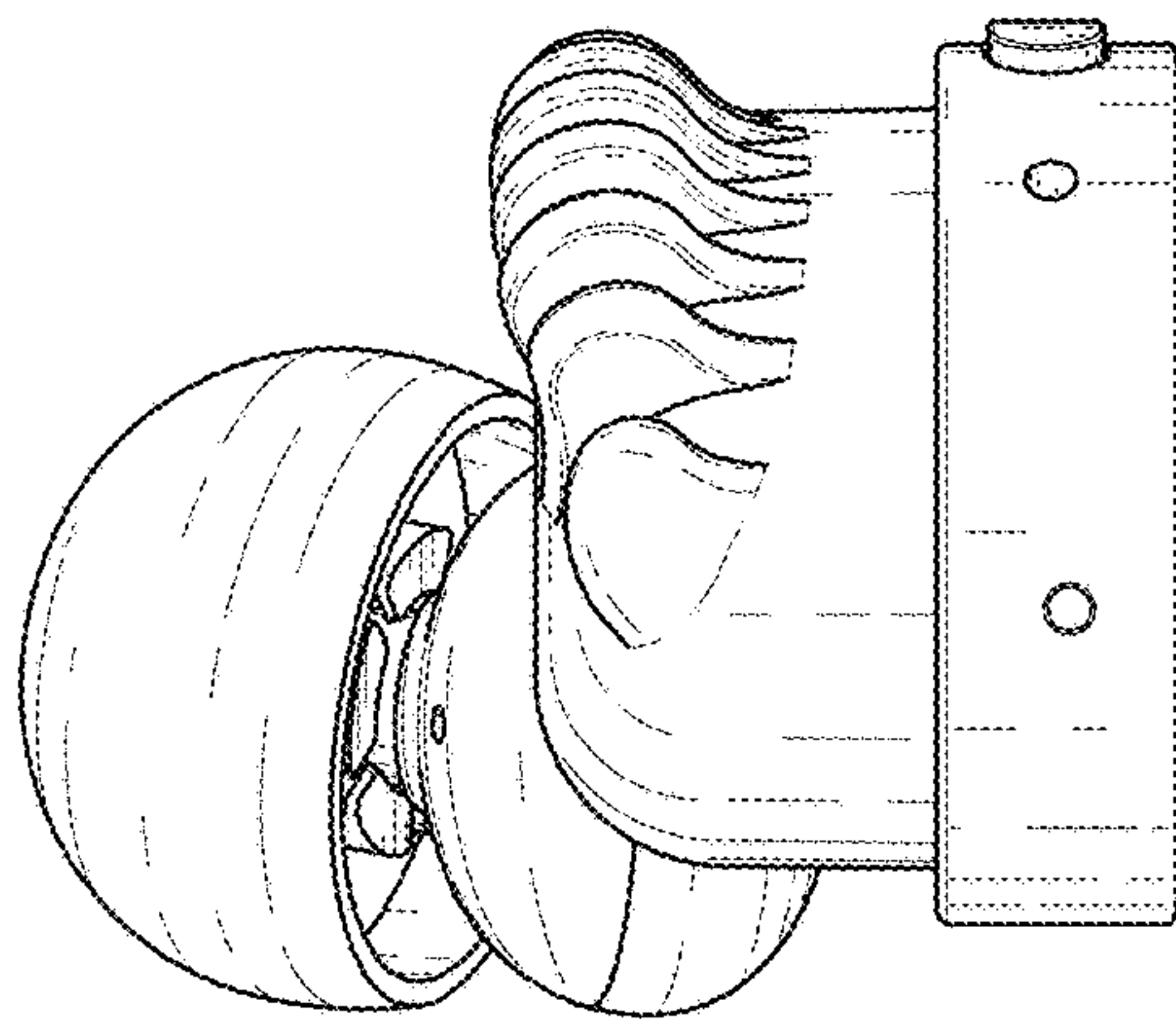

Fig. 6

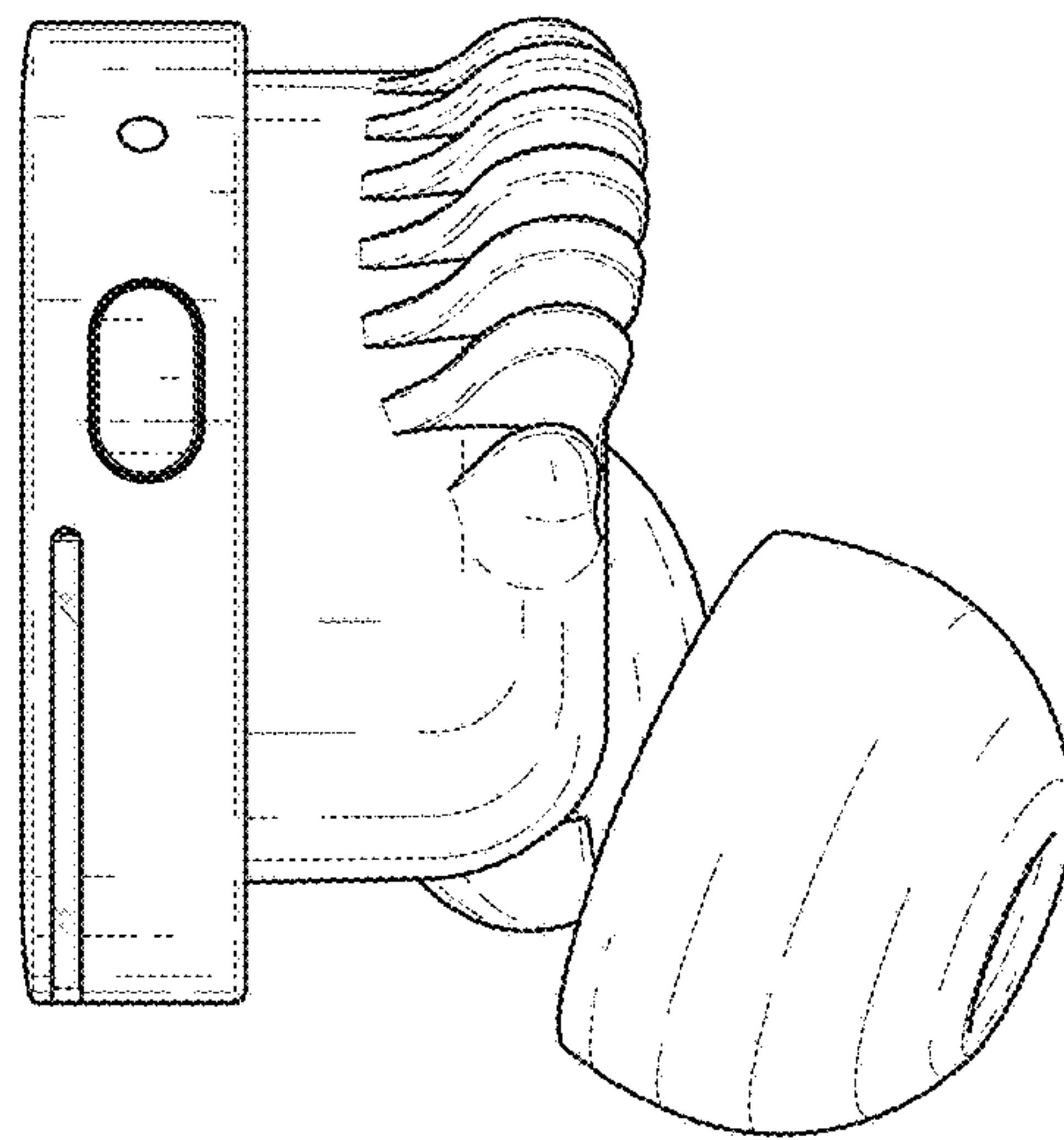

Fig. 7

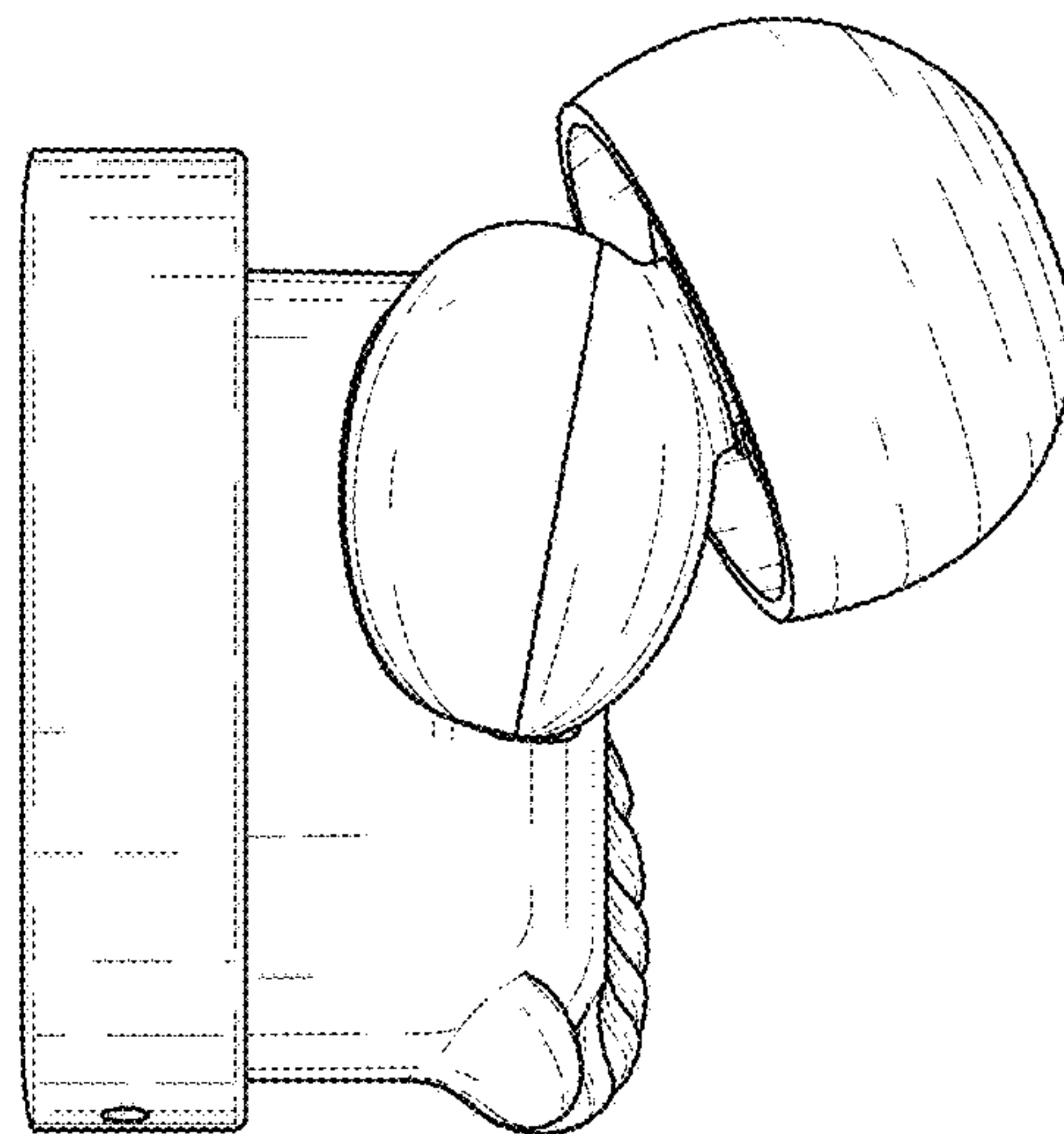

Fig. 8