



US00D860943S

(12) **United States Design Patent** (10) **Patent No.:** **US D860,943 S**  
**Xie** (45) **Date of Patent:** **\*\* Sep. 24, 2019**

(54) **BATTERY BOX**  
(71) Applicant: **Huarong Xie**, Guangdong (CN)  
(72) Inventor: **Huarong Xie**, Guangdong (CN)  
(\*\*) Term: **15 Years**  
(21) Appl. No.: **29/624,183**  
(22) Filed: **Oct. 30, 2017**  
(51) **LOC (12) Cl.** ..... **13-02**  
(52) **U.S. Cl.**  
USPC ..... **D13/119**  
(58) **Field of Classification Search**  
USPC ..... D13/103, 107-108, 118-119, 184, 199;  
D3/273, 274, 302, 201, 264  
CPC .... H01M 2/04; H01M 2/0404; H01M 2/0406;  
H01M 2/0465; H01M 2/06  
See application file for complete search history.

D811,740 S \* 3/2018 Harrison ..... D3/264  
D816,994 S \* 5/2018 Fischer ..... D3/294  
D820,593 S \* 6/2018 Harrison ..... D3/264  
D822,507 S \* 7/2018 Vivone ..... D10/30  
D829,381 S \* 9/2018 Kim ..... D28/93  
D837,148 S \* 1/2019 Brown ..... D13/108  
D839,189 S \* 1/2019 Miller ..... D13/108  
D841,585 S \* 2/2019 Huang ..... D13/119  
D848,946 S \* 5/2019 Xie ..... D13/119

\* cited by examiner

*Primary Examiner* — Rosemary K Tarcza

(57) **CLAIM**

The ornamental design for a battery box, as shown and described.

**DESCRIPTION**

FIG. 1 is a perspective view of a battery box, showing my new design;  
FIG. 2 is a front elevational view thereof;  
FIG. 3 is a rear elevational view thereof;  
FIG. 4 is a left side view thereof;  
FIG. 5 is a right side view thereof;  
FIG. 6 is a top plan view thereof; and,  
FIG. 7 is a bottom plan view thereof.  
The broken lines shown in the drawings are for the purpose of illustrating portions of the battery box which form no part of the claimed design.

(56) **References Cited**  
U.S. PATENT DOCUMENTS

D411,953 S 7/1999 Wolff  
D439,561 S \* 3/2001 Lee, IV ..... D13/103  
D455,550 S 4/2002 Wolf  
D515,027 S \* 2/2006 Groh ..... D13/103  
D575,734 S \* 8/2008 Groh ..... D13/119  
D645,247 S 9/2011 Hoffman  
D723,274 S \* 3/2015 Almanaseer ..... D3/264  
D731,411 S \* 6/2015 Nakaishi ..... D13/103  
D777,100 S \* 1/2017 Price ..... D13/103

**1 Claim, 7 Drawing Sheets**

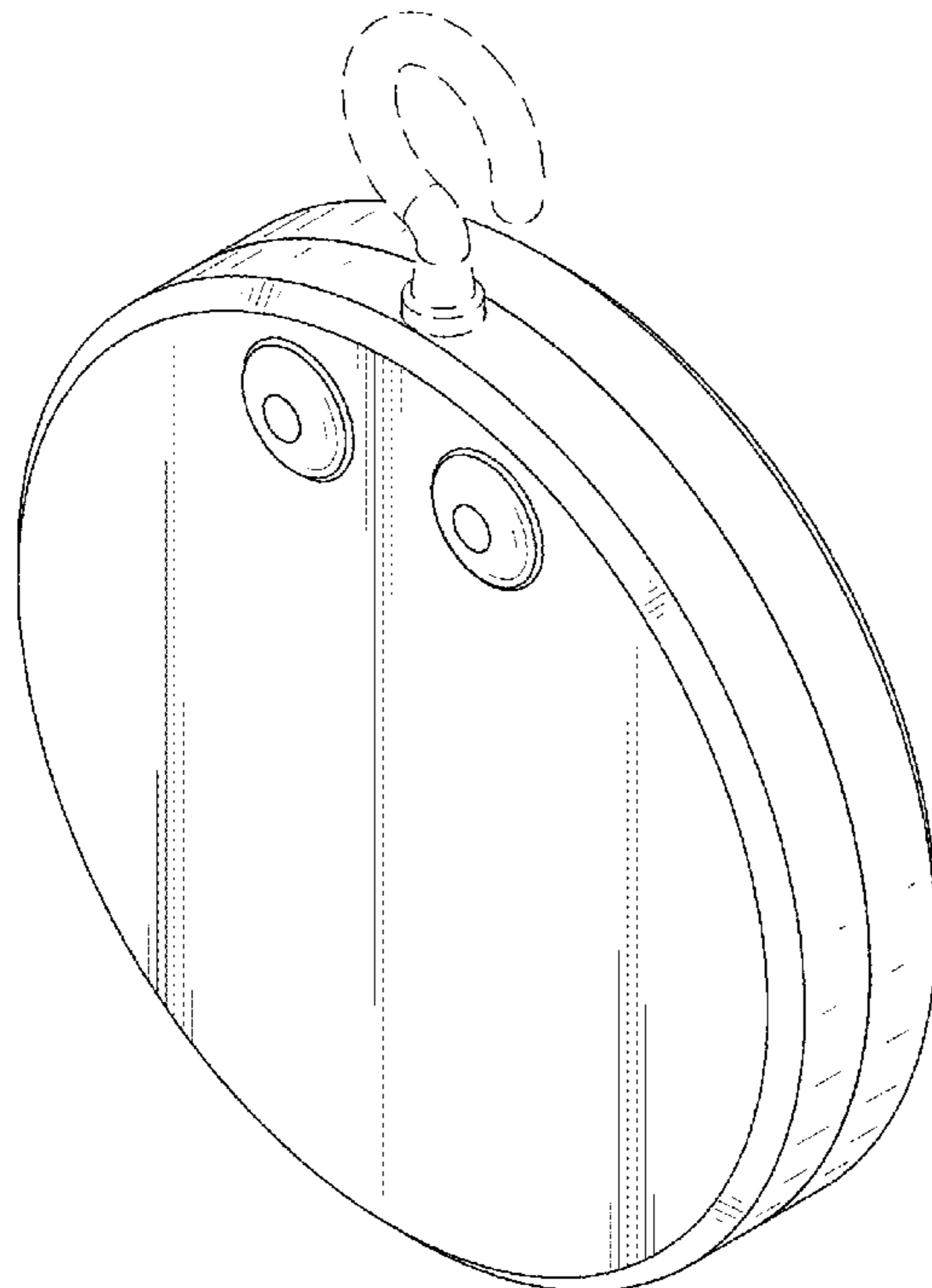

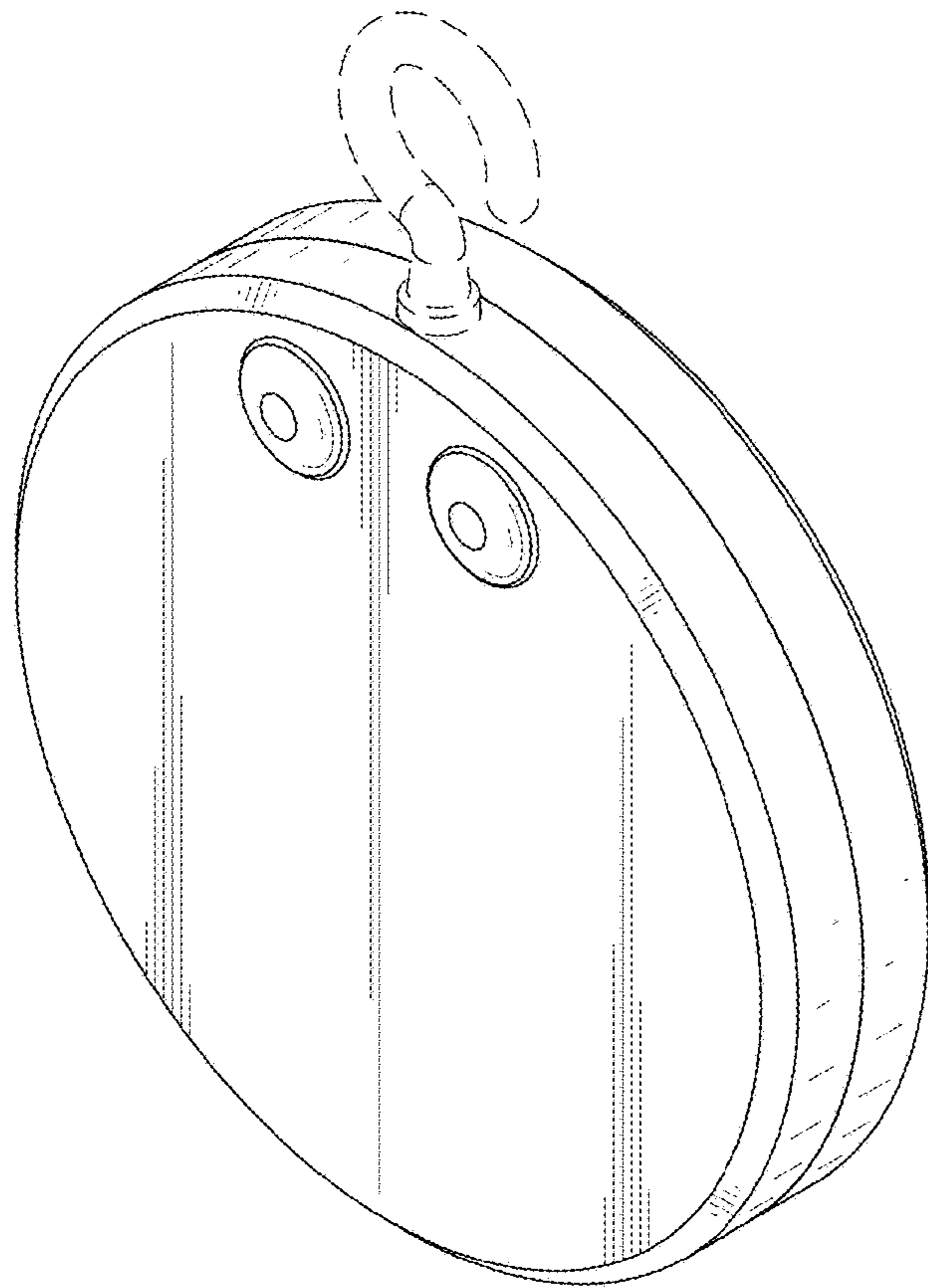

FIG. 1

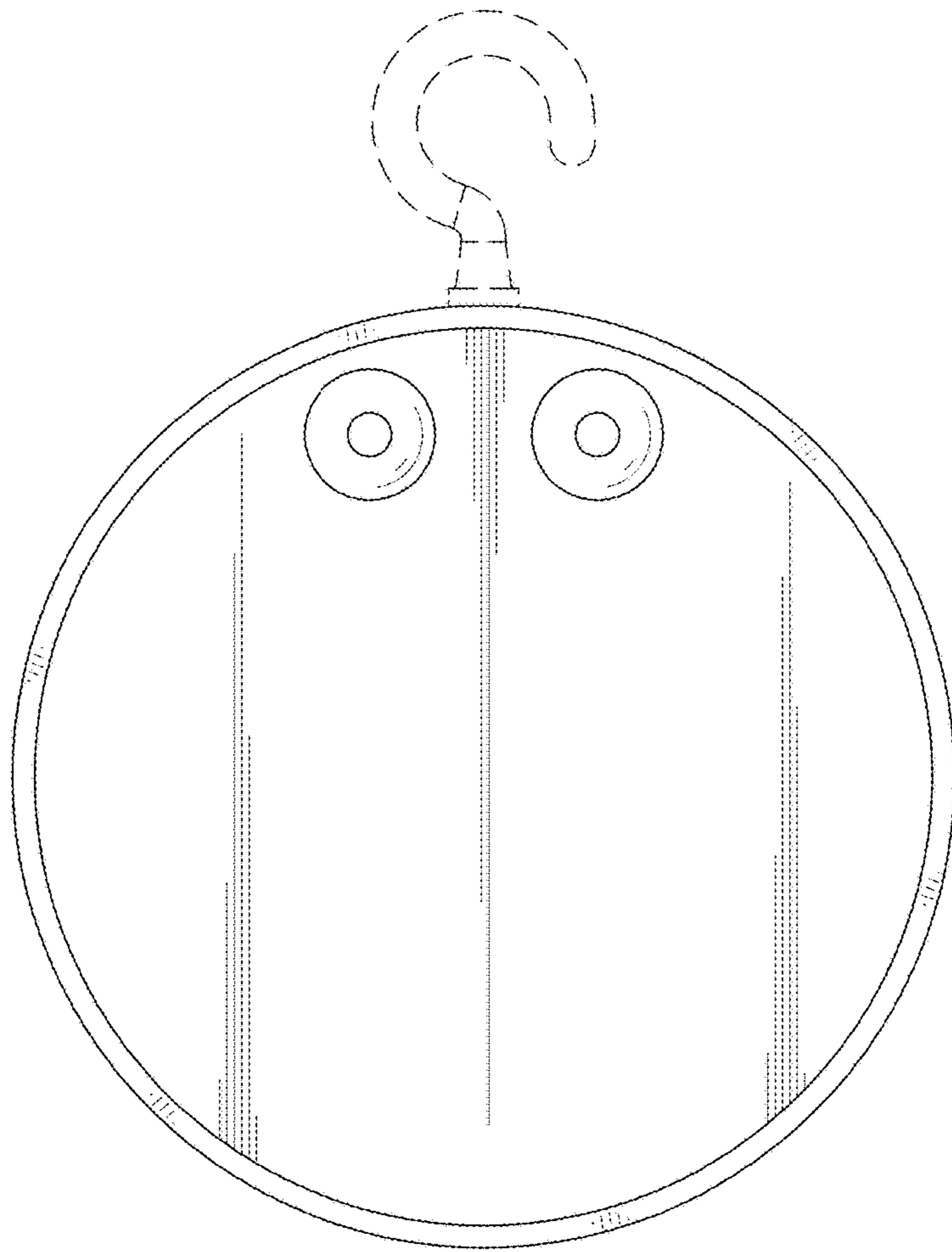

FIG. 2

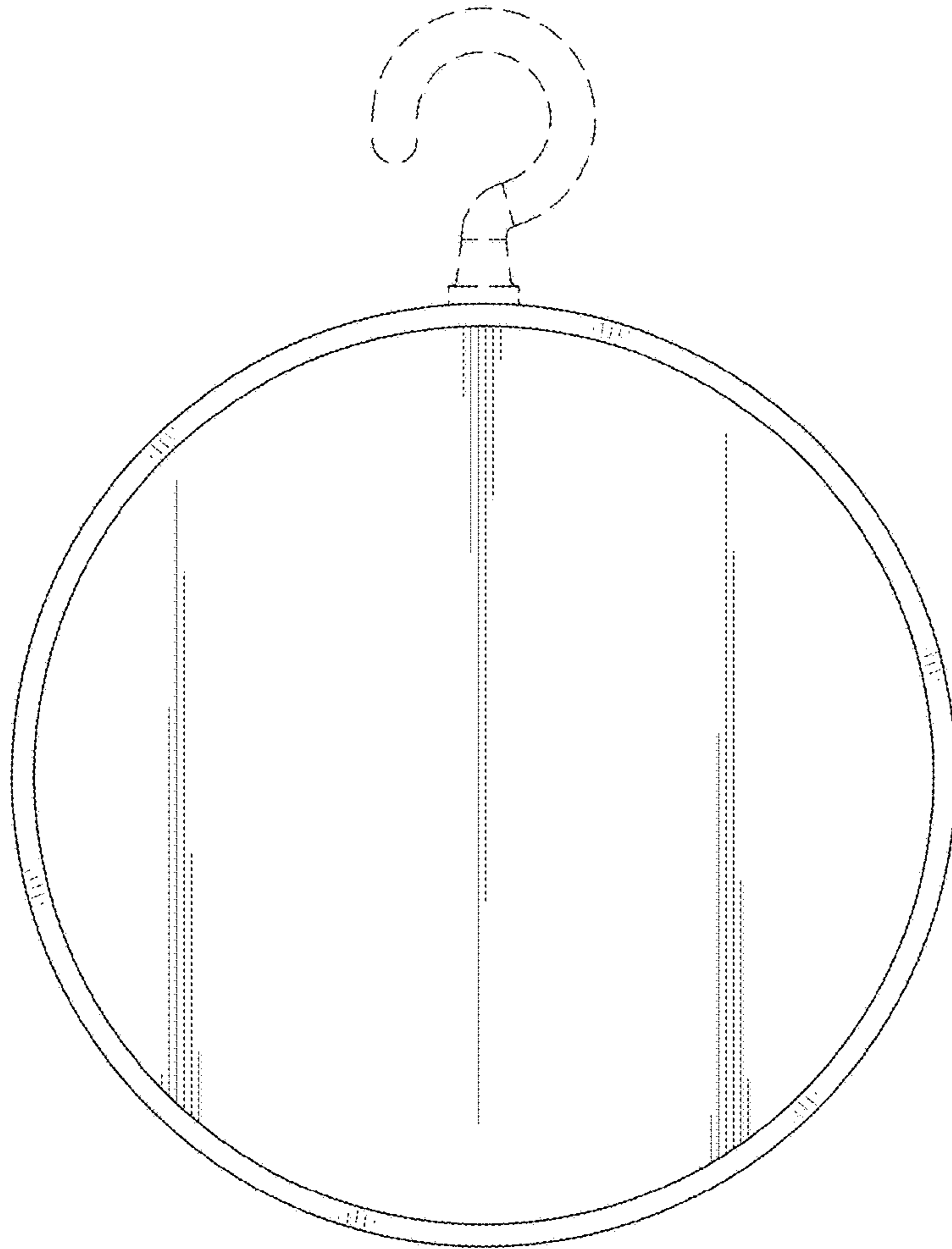

FIG. 3

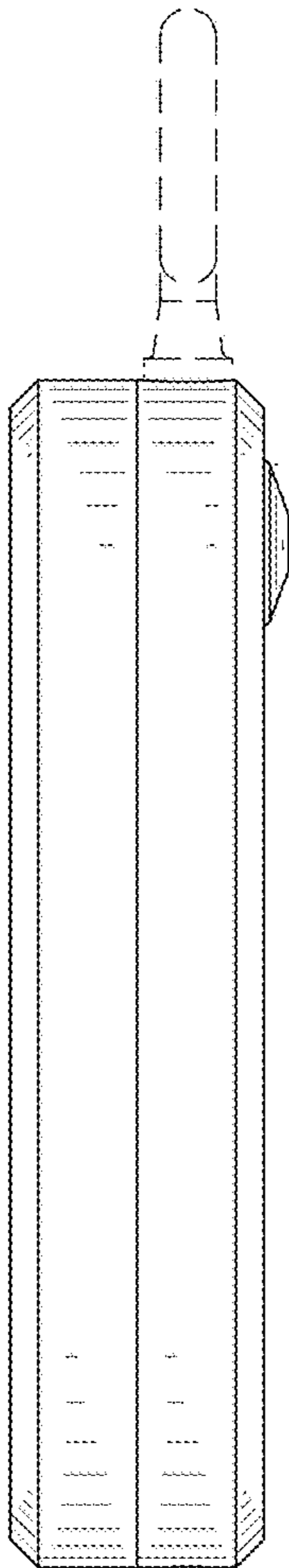

FIG. 4

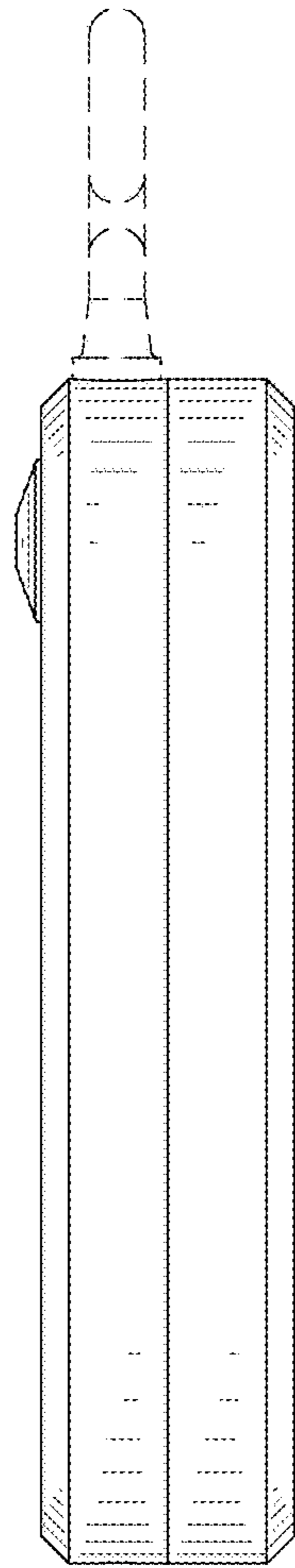

FIG. 5

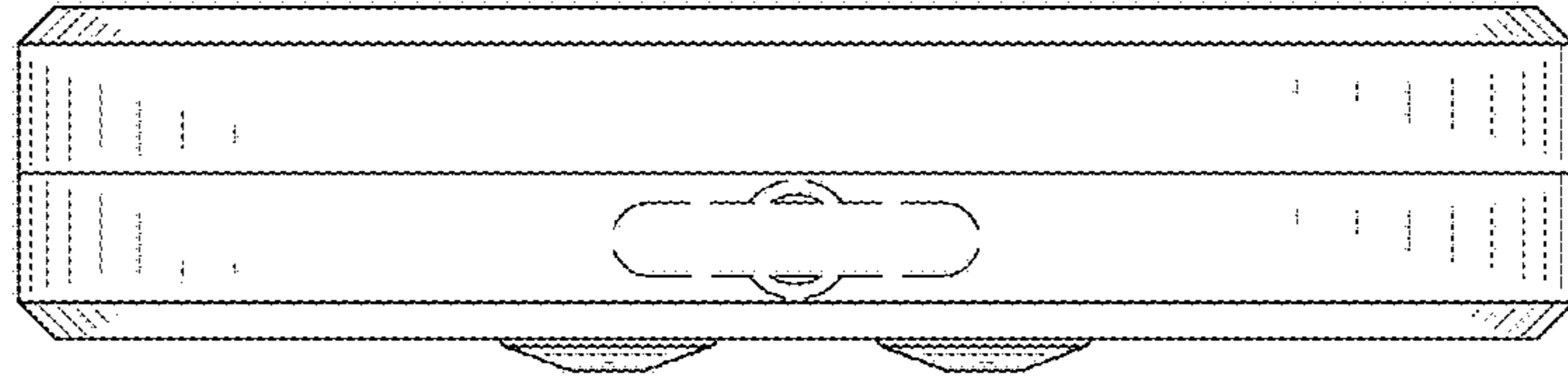

FIG. 6

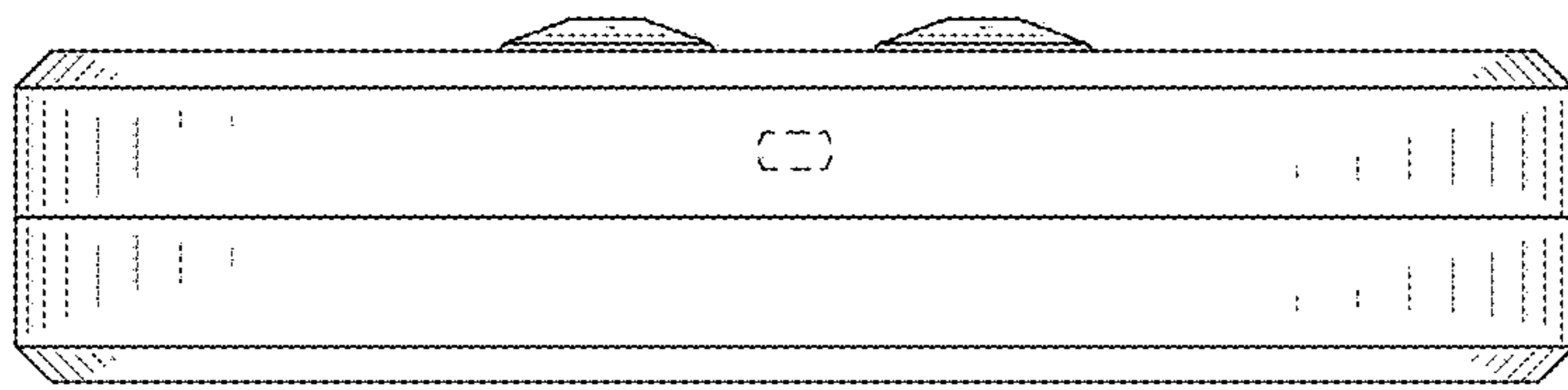

FIG. 7