



US00D860882S

(12) **United States Design Patent** (10) **Patent No.:** **US D860,882 S**
Ninov et al. (45) **Date of Patent:** **** Sep. 24, 2019**

(54) **VEHICLE FRONT END**
(71) Applicants: **Deyan Ninov**, Royal Oak, MI (US);
Michael Gillam, Oxford, MI (US);
Gregory A Howell, Farmington, MI (US)
(72) Inventors: **Deyan Ninov**, Royal Oak, MI (US);
Michael Gillam, Oxford, MI (US);
Gregory A Howell, Farmington, MI (US)

D798,201 S * 9/2017 Zavatski D12/169
D828,227 S * 9/2018 Ninov D12/98
D836,032 S * 12/2018 Ninov D12/98
D836,033 S * 12/2018 Ninov D12/98
D836,034 S * 12/2018 Scott D12/98
D836,035 S * 12/2018 Scott D12/98
D836,036 S * 12/2018 Ninov D12/98
D837,099 S * 1/2019 Ninov D12/98
D837,694 S * 1/2019 Ninov D12/98
D842,776 S * 3/2019 Basmanov D12/169
D847,029 S * 4/2019 Ninov D12/98
D847,030 S * 4/2019 Ninov D12/98

(73) Assignee: **FCA US LLC**, Auburn Hills, MI (US)

* cited by examiner

(**) Term: **15 Years**

Primary Examiner — Melody N Brown

(21) Appl. No.: **29/673,675**

(74) *Attorney, Agent, or Firm* — Ralph E. Smith

(22) Filed: **Dec. 17, 2018**

(57) **CLAIM**

Related U.S. Application Data

The ornamental design for an vehicle front end, as shown and described.

(63) Continuation-in-part of application No. 29/626,553, filed on Nov. 17, 2017, now Pat. No. Des. 837,099.

(51) **LOC (12) Cl.** **12-16**

(52) **U.S. Cl.**
USPC **D12/164**; D12/91

DESCRIPTION

(58) **Field of Classification Search**
USPC D12/90–92, 86, 196, 163, 164, 169;
293/102, 113, 115, 117, 120; 296/180.1,
296/180.2; 280/181.1, 181.5
CPC B62D 35/00; B62D 25/00; B62D 25/06;
B62D 33/00
See application file for complete search history.

FIG. 1 is a front perspective view of a vehicle front end showing our new design;
FIG. 2 is a front view thereof;
FIG. 3 is a rear view thereof;
FIG. 4 is a right side view thereof;
FIG. 5 is a left side view thereof;
FIG. 6 is a top view thereof; and,
FIG. 7 is a bottom view thereof.

(56) **References Cited**

It will be understood that the broken lines shown in the drawings illustrate portions of the vehicle front end that form no part of claimed design.

U.S. PATENT DOCUMENTS

D761,163 S * 7/2016 Sato D12/164
D790,413 S * 6/2017 Doyle D12/164

1 Claim, 6 Drawing Sheets

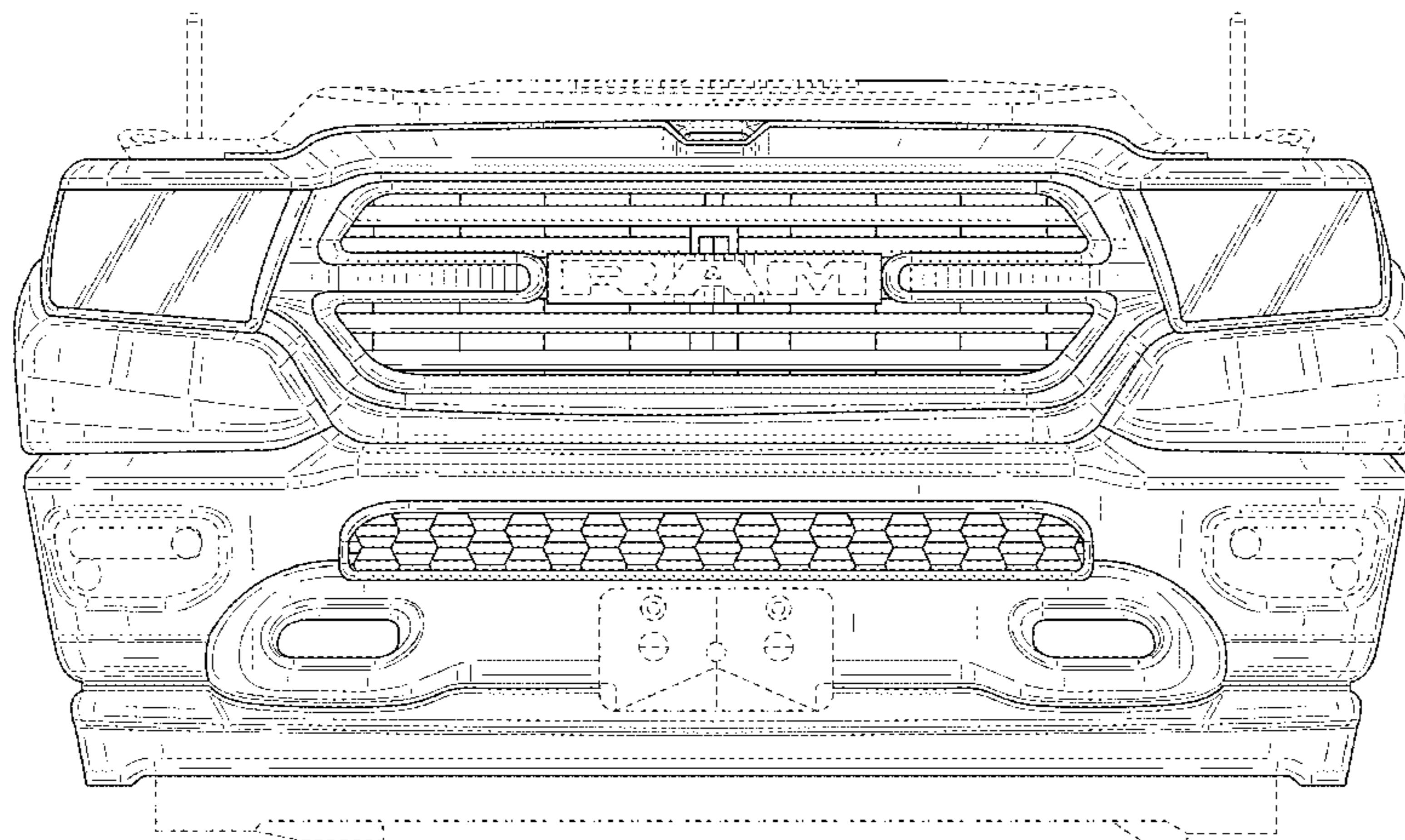

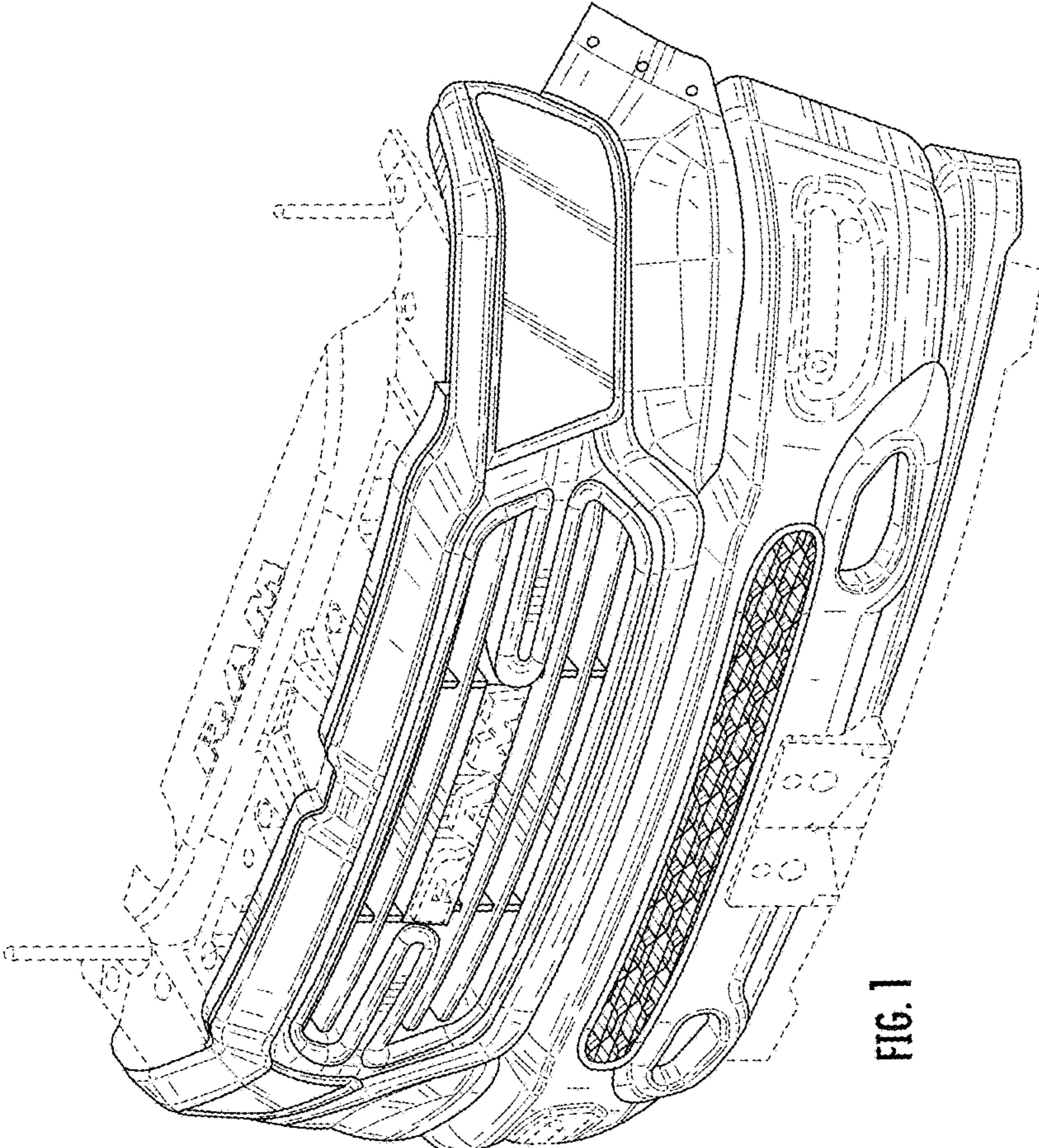

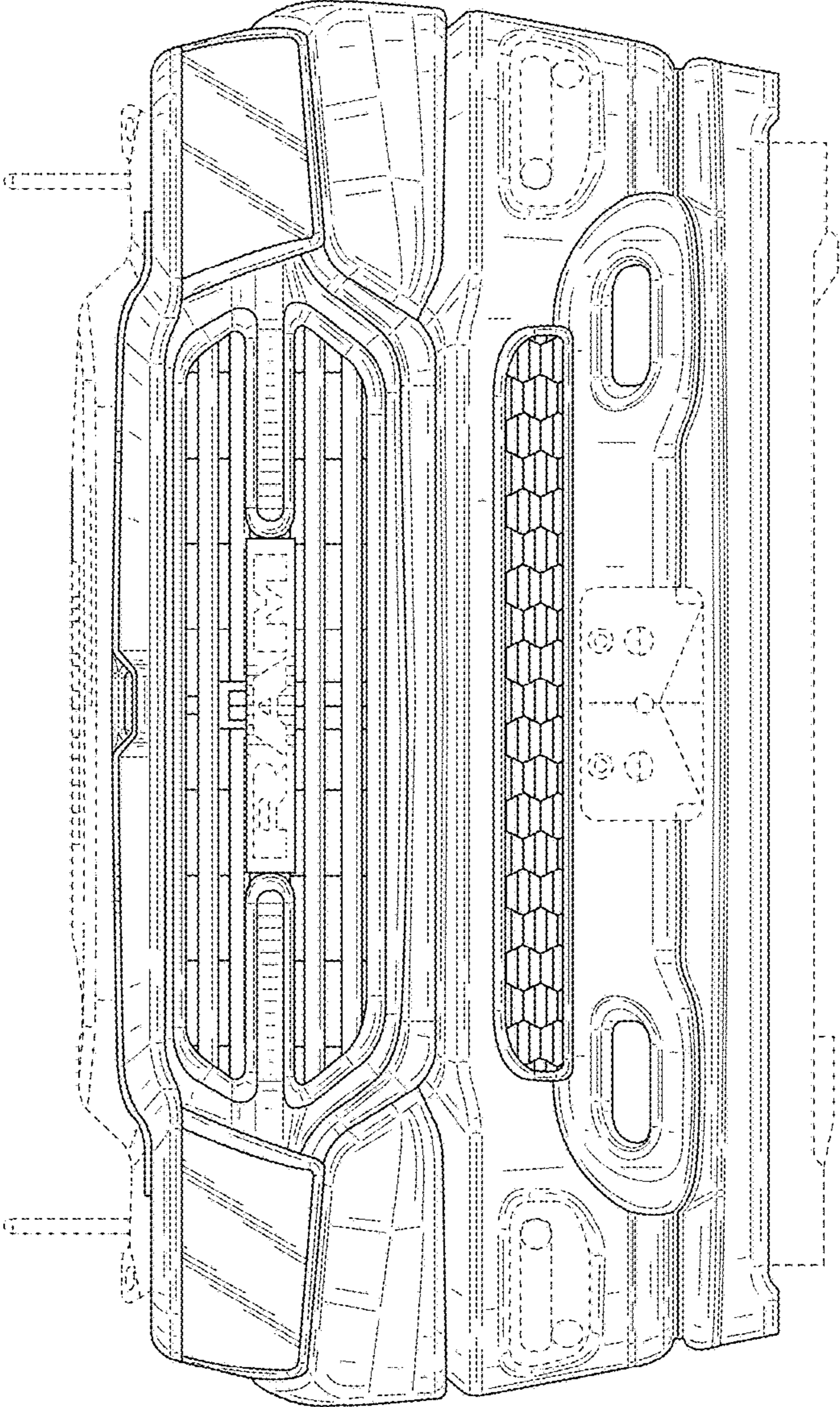

FIG. 2

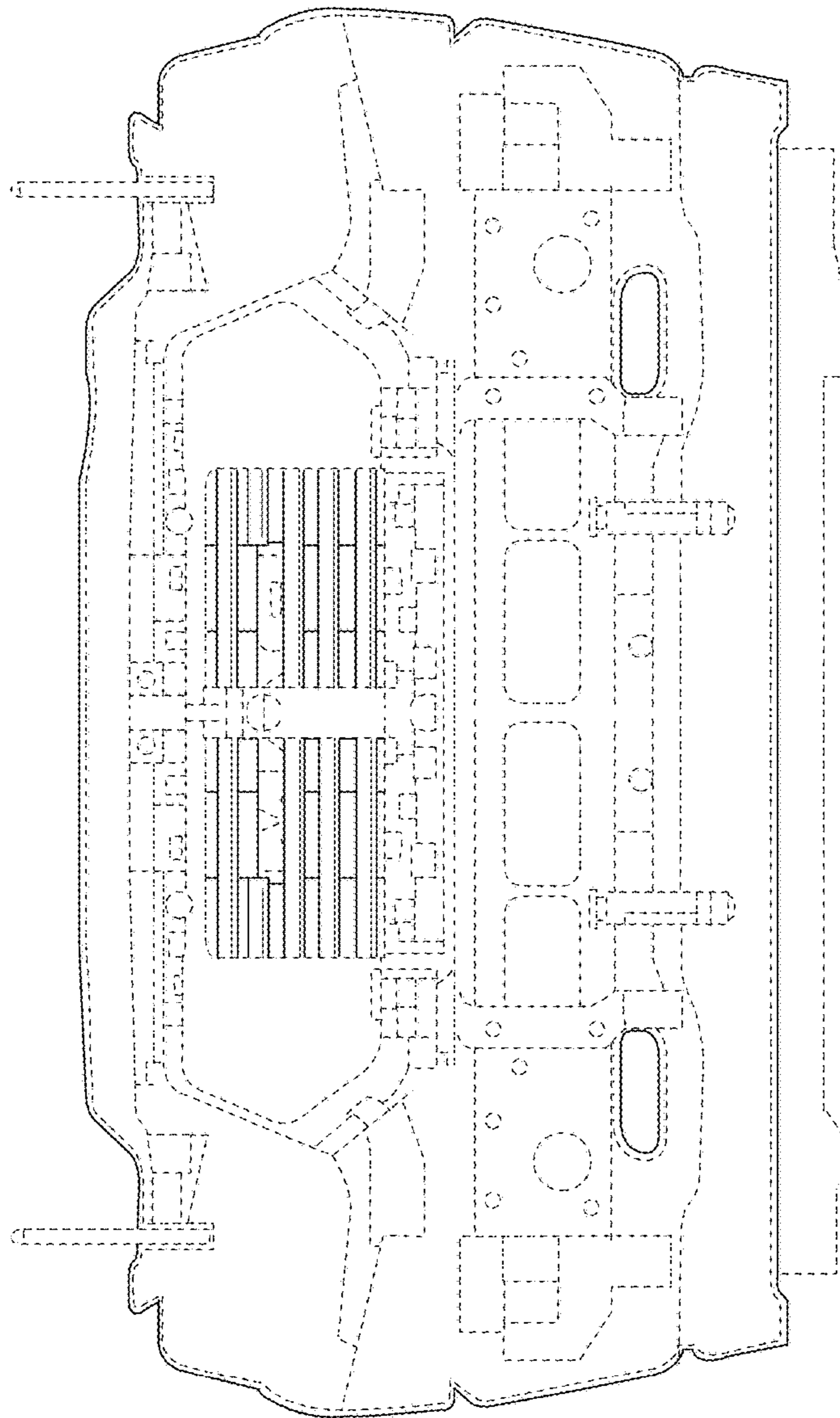

FIG. 3

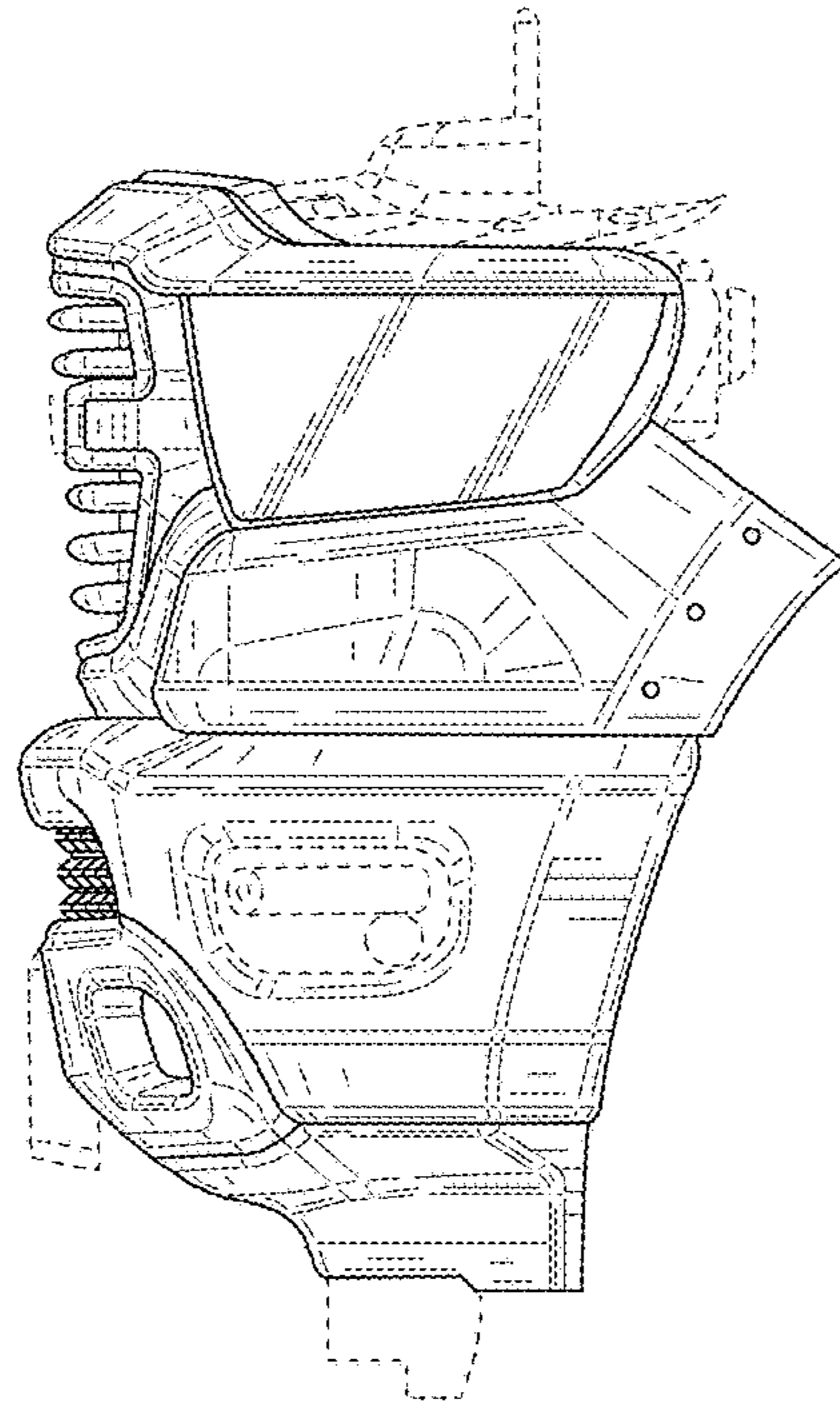

FIG. 4

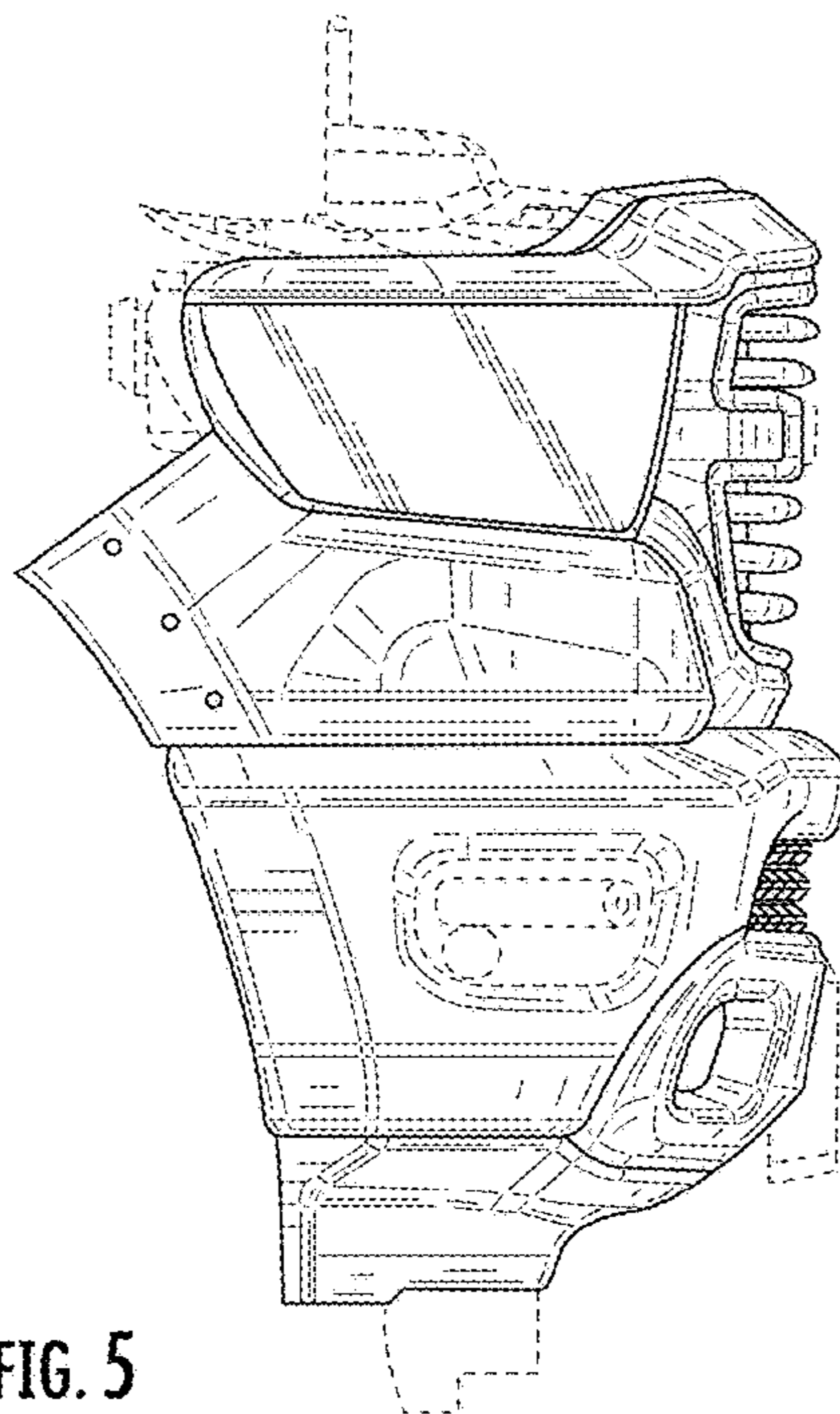

FIG. 5

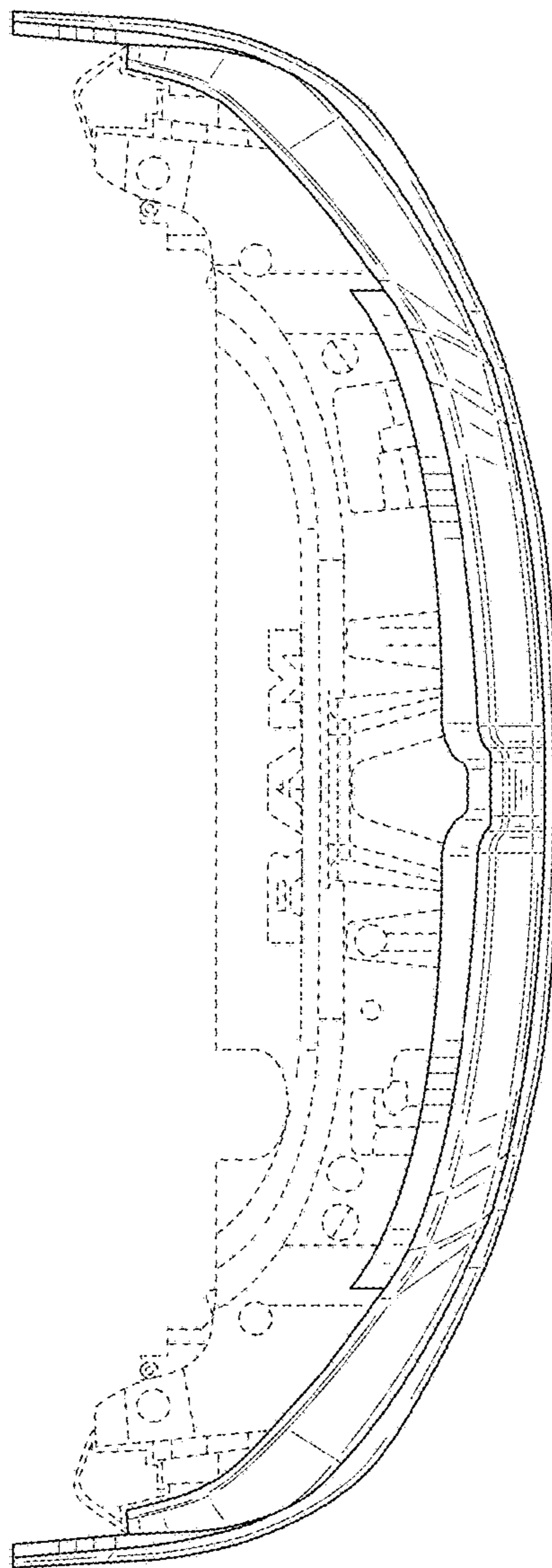

FIG. 6

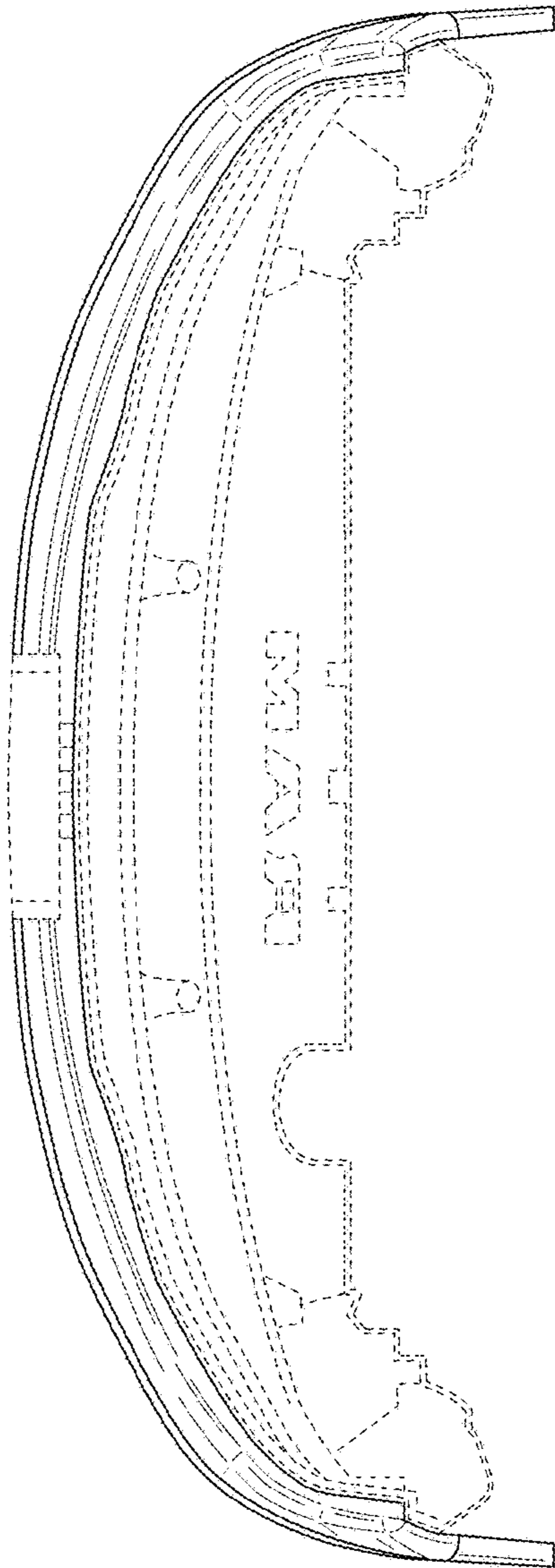

FIG. 7