



US00D860793S

(12) **United States Design Patent**
Cartis et al.

(10) **Patent No.:** **US D860,793 S**

(45) **Date of Patent:** **** *Sep. 24, 2019**

(54) **BOTTLE**

(71) Applicant: **PepsiCo, Inc.**, Purchase, NY (US)

(72) Inventors: **Emilian Dan Cartis**, London (GB);
Ryan James Campbell, New York, NY (US);
Niklas Gustafsson, New York, NY (US);
Meatta T. Kemokai, Stamford, CT (US);
Kamal Mahajan, Tarrytown, NY (US);
Syed Peer, Arlington Heights, IL (US);
Bruno Telesca, Sandy Hook, CT (US);
Koby Hebborn Trout, Brooklyn, NY (US);
Moreno Barel, Refrontolo (IT)

(73) Assignee: **PepsiCo, Inc.**, Purchase, NY (US)

(*) Notice: This patent is subject to a terminal disclaimer.

(**) Term: **15 Years**

(21) Appl. No.: **29/634,312**

(22) Filed: **Jan. 19, 2018**

(51) **LOC (12) Cl.** **09-01**

(52) **U.S. Cl.**
USPC **D9/503**; D9/520; D9/558

(58) **Field of Classification Search**
USPC D7/300, 500, 507, 509, 523, 590, 598,
D7/602, 619.1; D9/453, 500, 503, 516,
D9/520, 529, 530, 539, 540, 544-546,
D9/549, 550, 558, 715, 719; D3/202
CPC B65D 41/42; B65D 1/0246; B65D 1/0223;
B65D 21/022

See application file for complete search history.

(56) **References Cited**

U.S. PATENT DOCUMENTS

D78,628 S 5/1929 Kart
D81,520 S 7/1930 Bromiley

D197,919 S 4/1964 Runyon
3,446,382 A 5/1969 Koll et al.
D219,125 S 11/1970 Gortz et al.
D281,584 S 12/1985 Berglund
4,586,863 A 5/1986 Morimoto et al.
D295,259 S 4/1988 Goettner
D295,260 S 4/1988 Goettner
4,768,667 A 9/1988 Magnusson
D308,828 S 6/1990 Magnusson
D329,803 S 9/1992 Otsuka
D379,312 S * 5/1997 Crawford D9/557
D573,023 S 7/2008 Pivert
D596,942 S 7/2009 Britto
D608,204 S 1/2010 Caroen et al.
D616,754 S 6/2010 Arnell et al.
D617,644 S * 6/2010 Leventhal D9/517
D634,205 S 3/2011 Arnell et al.
D652,319 S 1/2012 Cohen et al.

(Continued)

OTHER PUBLICATIONS

Idea, No. 6, vol. 37, p .89 (Nov. 1, 1989).

Primary Examiner — Ian Simmons

Assistant Examiner — Keith Frank

(74) *Attorney, Agent, or Firm* — Sterne, Kessler,
Goldstein & Fox P.L.L.C.

(57) **CLAIM**

The ornamental design for a bottle, as shown and described.

DESCRIPTION

FIG. 1 is a top front perspective view of a bottle showing the claimed design;

FIG. 2 is a bottom front perspective view thereof;

FIG. 3 is a front view thereof;

FIG. 4 is a rear view thereof;

FIG. 5 is a left side view thereof;

FIG. 6 is a right side view thereof;

FIG. 7 is a top view thereof; and,

FIG. 8 is a bottom view thereof.

1 Claim, 7 Drawing Sheets

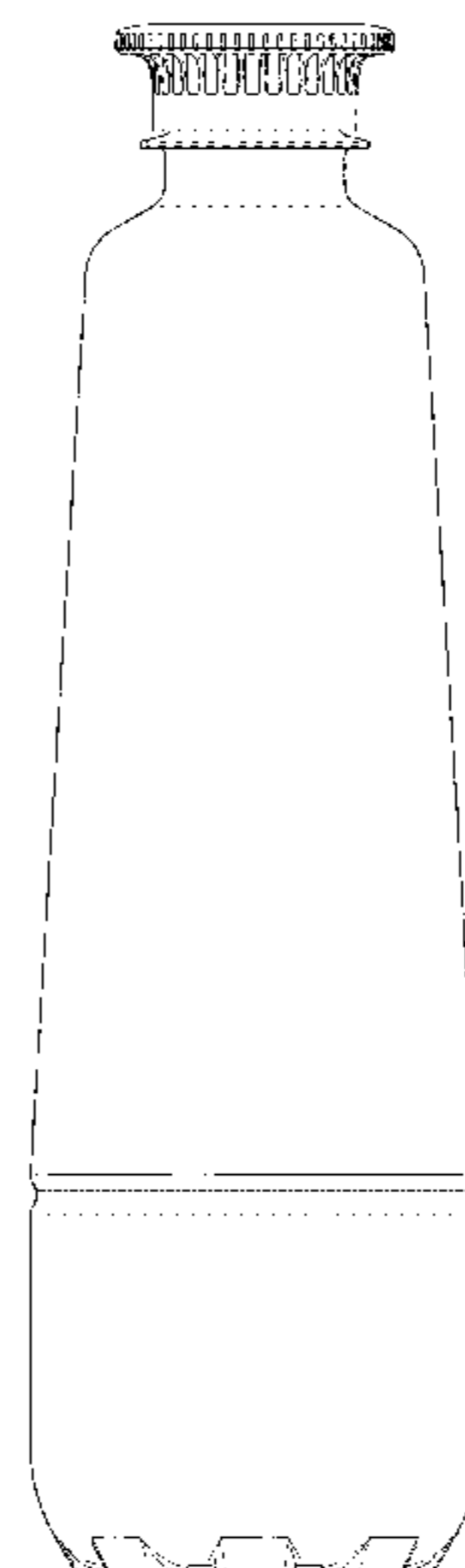
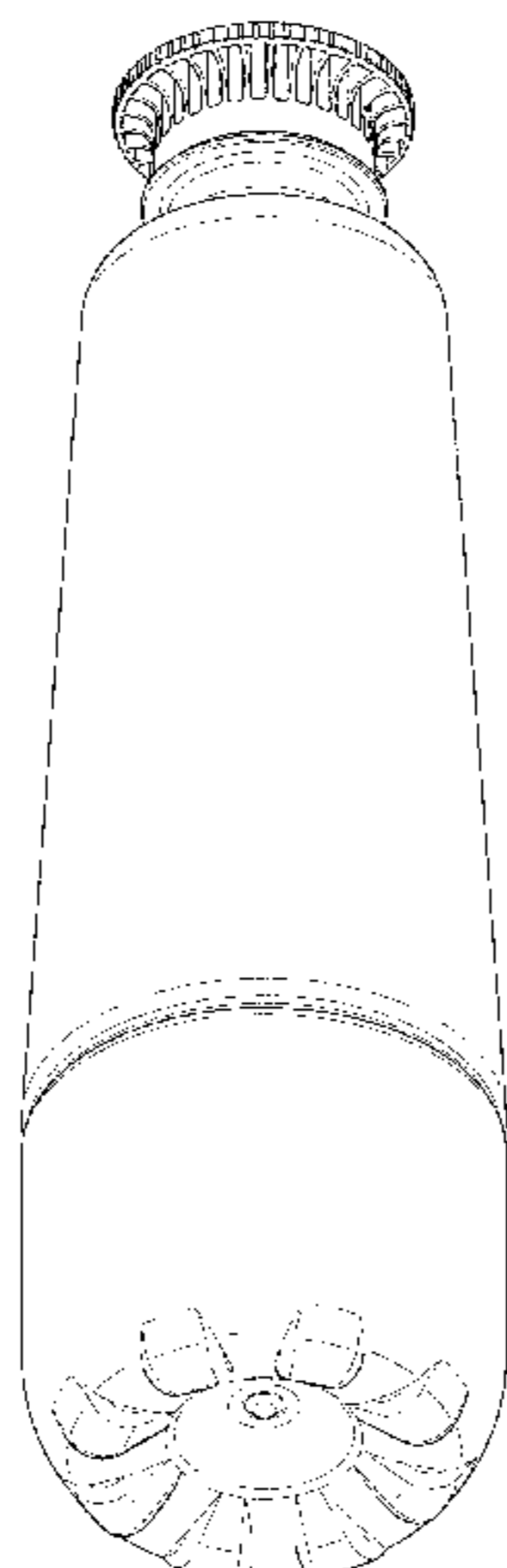

(56)

References Cited

U.S. PATENT DOCUMENTS

D663,618 S	7/2012	Cohen et al.	
D671,409 S	11/2012	Cohen et al.	
D675,527 S	2/2013	Rogers et al.	
D714,155 S	9/2014	Tanaka et al.	
D720,624 S *	1/2015	Eyles	D9/537
D727,159 S *	4/2015	Barjon	D9/500
D745,398 S	12/2015	Cotton	
D758,206 S *	6/2016	Hoeke	D9/500
D772,070 S	11/2016	Broen et al.	
D784,144 S	4/2017	Cheng et al.	
D804,951 S *	12/2017	Broen	D9/500
D811,889 S *	3/2018	Cheng	D9/540
D815,908 S *	4/2018	Kauss	D7/511
D817,095 S *	5/2018	Kauss	D7/511
D821,201 S *	6/2018	Harris	D9/500
D821,205 S *	6/2018	Christianson	D9/503
D821,877 S *	7/2018	Harris	D9/516
D822,496 S *	7/2018	Jno-Charles	D9/552
D828,163 S *	9/2018	Renner	D9/500
D830,773 S *	10/2018	Jacobsen	D7/511
D830,774 S *	10/2018	Jacobsen	D7/511
D831,492 S *	10/2018	Bram	D9/504
D832,651 S *	11/2018	Wiet	D7/511
D836,904 S *	1/2019	Arman	D3/202
D836,905 S *	1/2019	Kehoe	D3/202
D839,673 S *	2/2019	Meyers	D7/510
D841,469 S *	2/2019	Christianson	D9/503

* cited by examiner

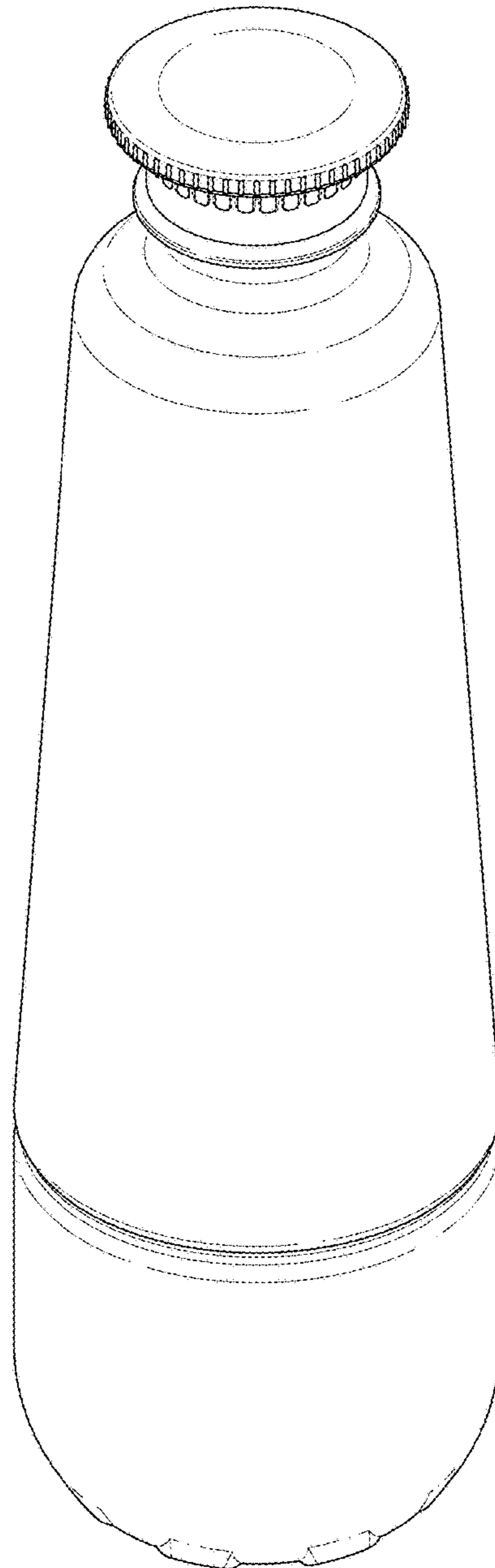

FIG. 1

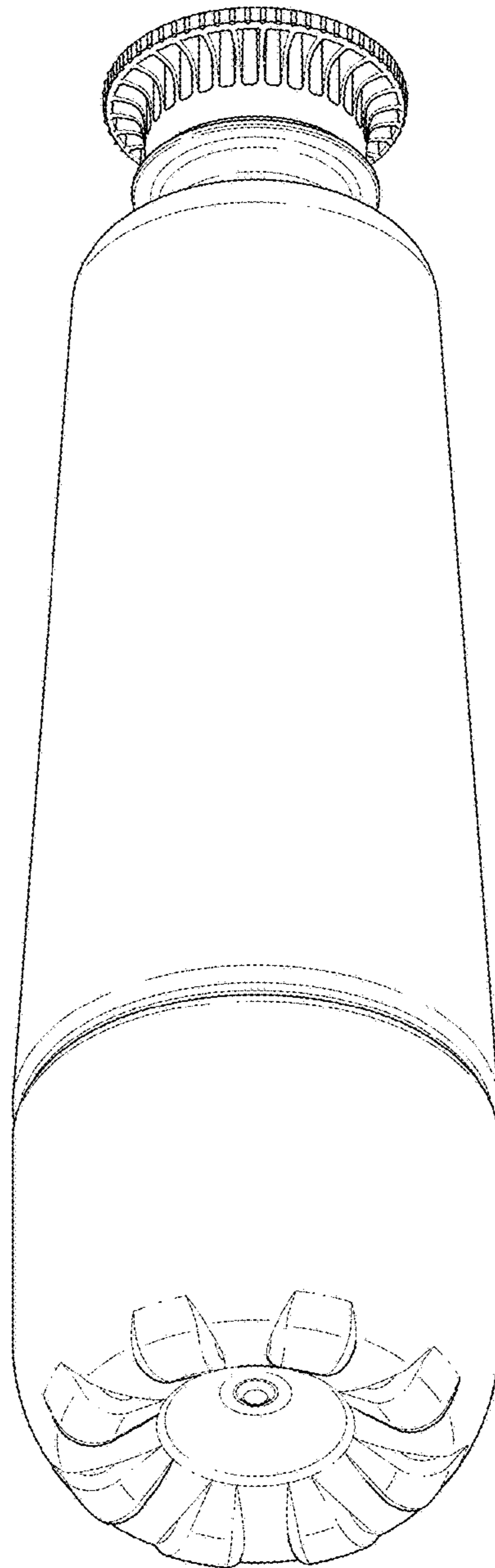

FIG. 2

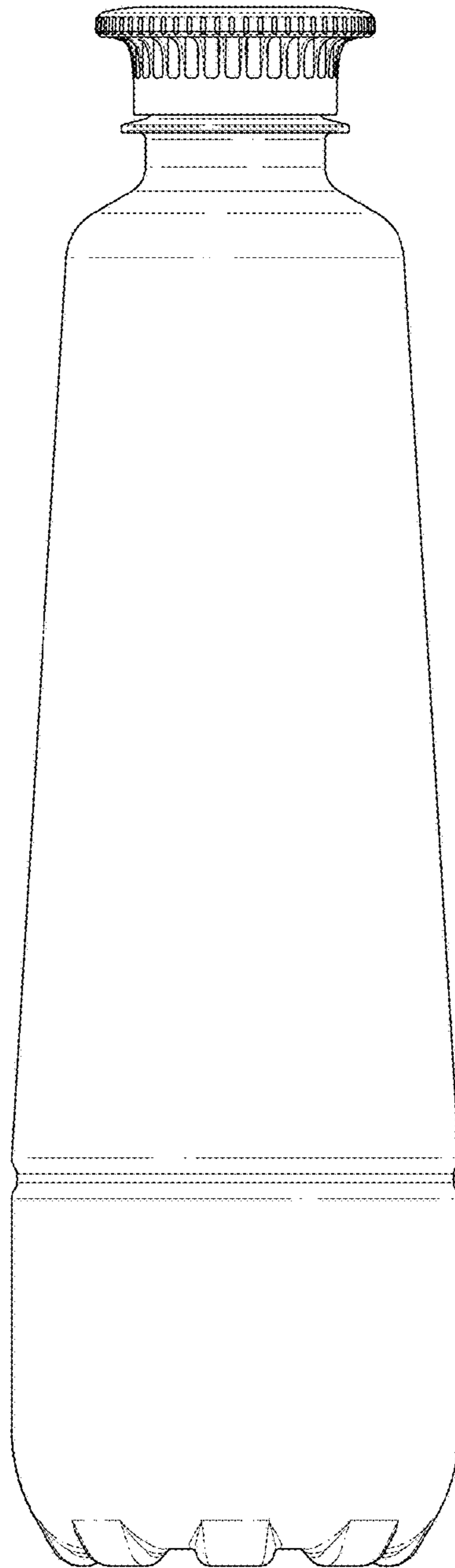

FIG. 3

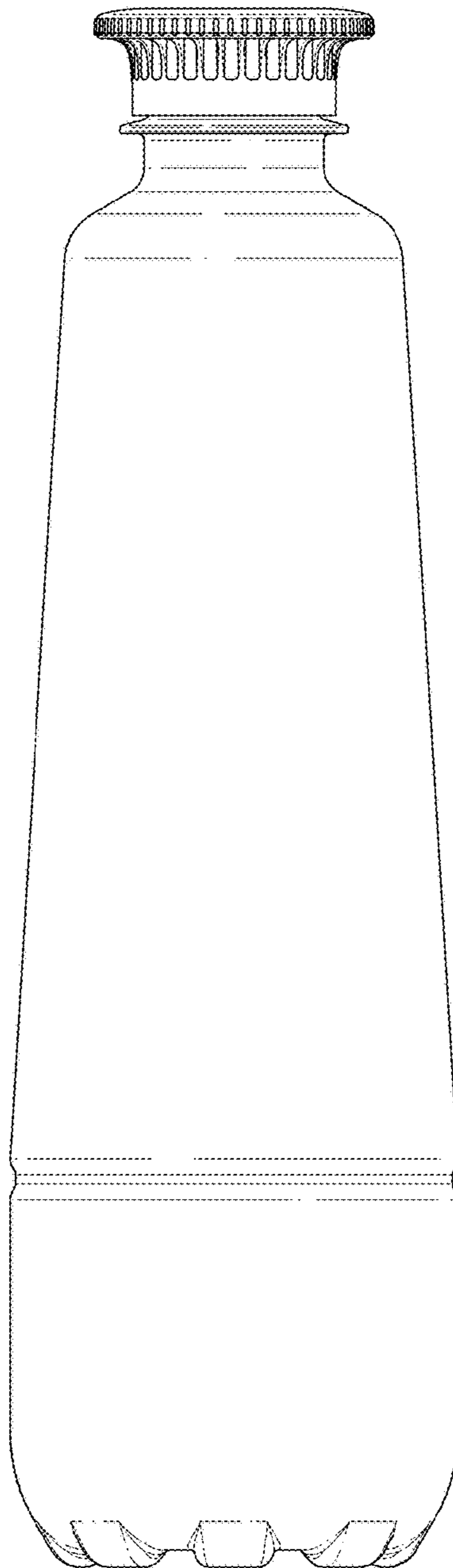

FIG. 4

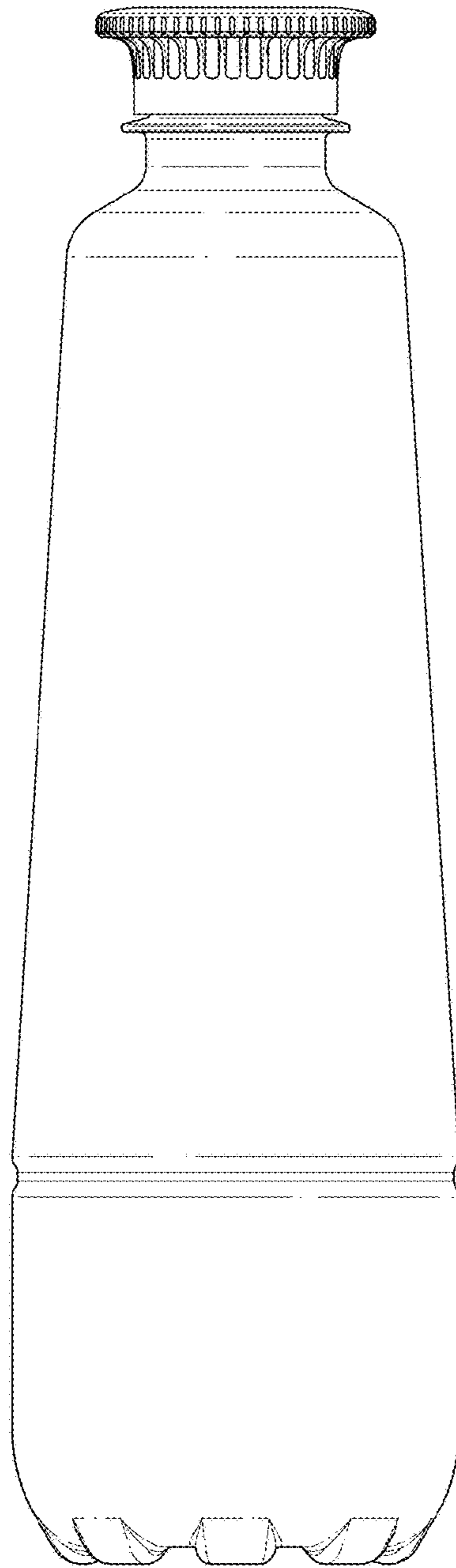

FIG. 5

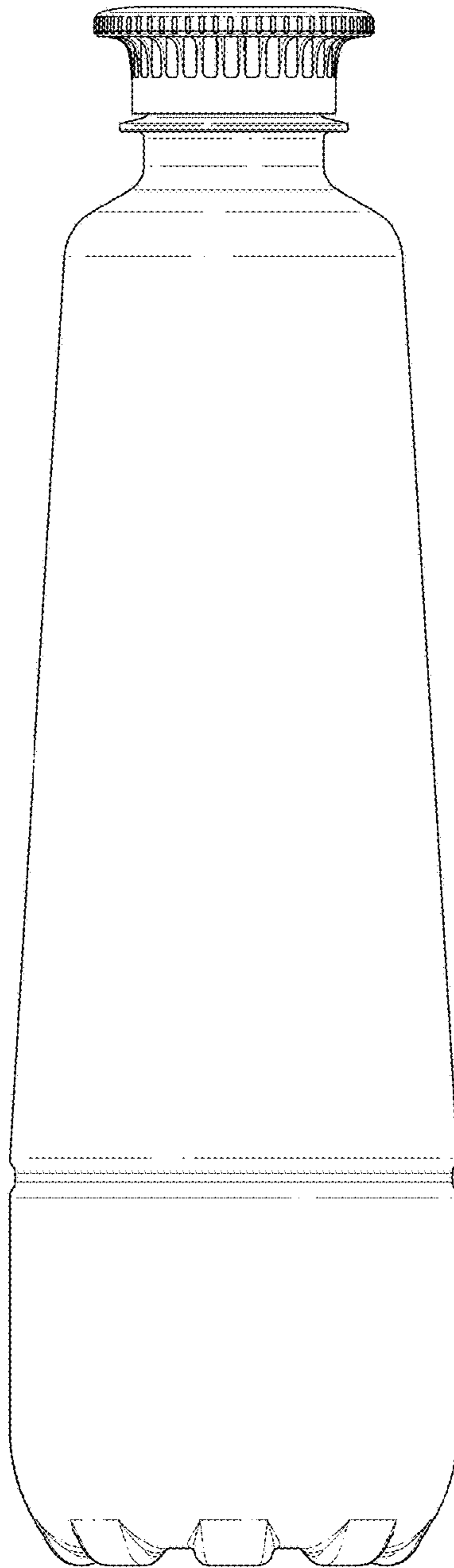

FIG. 6

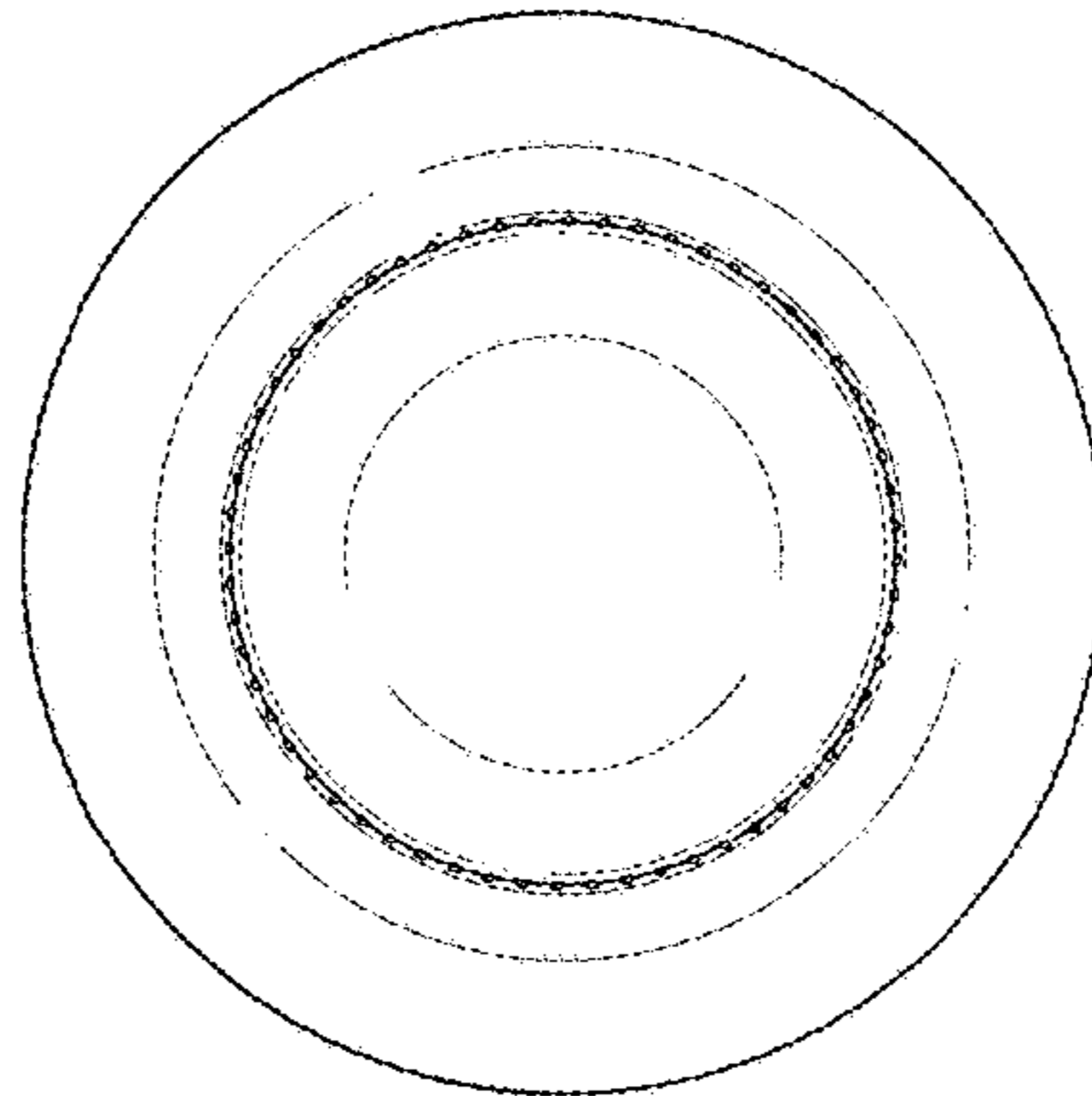

FIG. 7

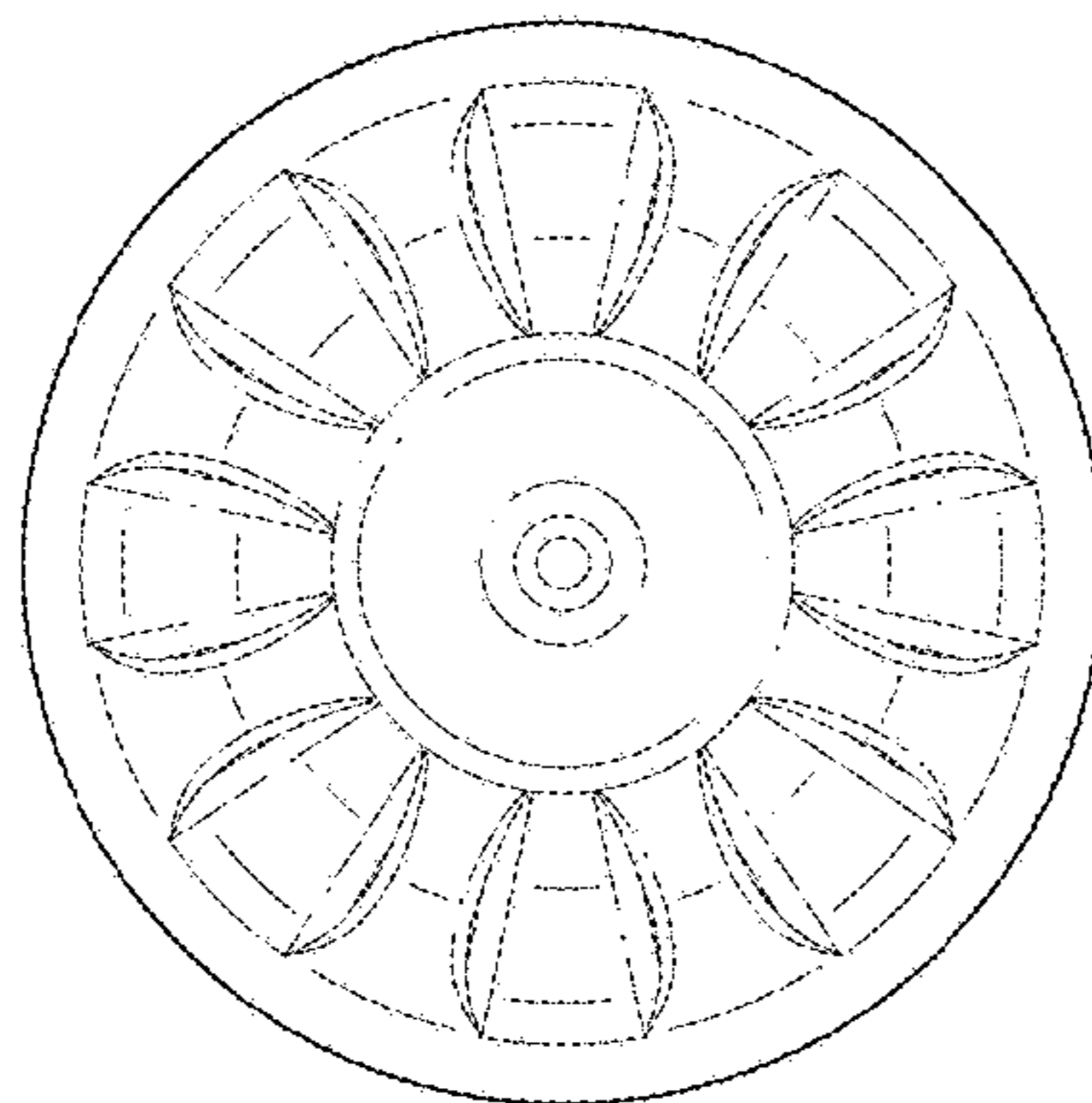

FIG. 8