



US00D860728S

(12) **United States Design Patent**
Hubert

(10) **Patent No.:** **US D860,728 S**

(45) **Date of Patent:** **** Sep. 24, 2019**

(54) **ROTISSERIE FRAME**

(71) Applicant: **KONINKLIJKE PHILIPS N.V.**,
Eindhoven (NL)

(72) Inventor: **Nicolas Hubert**, Shanghai (CN)

(73) Assignee: **KONINKLIJKE PHILIPS N.V.**,
Eindhoven (NL)

(**) Term: **15 Years**

(21) Appl. No.: **29/655,874**

(22) Filed: **Jul. 9, 2018**

(51) **LOC (12) Cl.** **07-02**

(52) **U.S. Cl.**
USPC **D7/409**

(58) **Field of Classification Search**
USPC D7/323, 332, 335-337, 354-355,
D7/359-365, 387-388, 402, 407-409
CPC A21B 2/00; A21B 3/00; A21B 3/13; A21B
3/15; A21B 5/00; A21B 5/02; A23N
12/06; A23N 12/08; A23N 12/10; A47J
37/00; A47J 37/04; A47J 37/041; A47J
37/042; A47J 37/06; A47J 37/0688; A47J
37/0694; A47J 37/07; A47J 37/0704;
A47J 37/0763; A47J 37/10; A47J 47/20;
A47J 2037/00; A47J 2037/06; A47J
2037/0611; A47J 2037/07; A47J
2037/0786; A47J 2037/0795; F24C 1/16;
F24C 15/10; F24C 15/12; F24C 15/14;
F24C 15/16; F24C 15/164; F24C 15/18
See application file for complete search history.

(56) **References Cited**

U.S. PATENT DOCUMENTS

D148,943 S * 3/1948 Nassif D7/338
3,297,166 A * 1/1967 Summers A47J 37/0694
211/60.1

3,858,495 A * 1/1975 Gotwalt A47J 37/0694
99/421 A
4,140,099 A * 2/1979 Newport F24C 1/16
126/43
4,220,133 A * 9/1980 Way, Jr. A47J 37/0704
126/337 A
4,363,313 A * 12/1982 Smith A47J 37/0763
126/9 R
D277,540 S * 2/1985 Thomas D7/337
D417,124 S * 11/1999 Chen 211/60.1
D423,867 S * 5/2000 Cael D7/332
D558,520 S * 1/2008 Raichlen D7/409
D559,621 S * 1/2008 Raichlen D7/409
D758,785 S * 6/2016 Verbrugge D7/352
D802,991 S * 11/2017 Dutruel D7/362

* cited by examiner

Primary Examiner — Ricky Pham

(57) **CLAIM**

The ornamental design for a rotisserie frame, as shown.

DESCRIPTION

FIG. 1 is a perspective view showing my design;
FIG. 2 is a front elevational view thereof;
FIG. 3 is a rear elevational view thereof;
FIG. 4 is a right side elevational view thereof;
FIG. 5 is a left side elevational view thereof;
FIG. 6 is a top plan view thereof;
FIG. 7 is a bottom plan view thereof.
FIG. 8 is a front elevational view of the rotisserie frame
broken down for transport; and,
FIG. 9 is a perspective view of the rotisserie frame carrying
a rotisserie spit and arranged on a grill.
The broken lines shown in the drawings are for illustrative
purposes only and form no part of the claimed design.

1 Claim, 6 Drawing Sheets

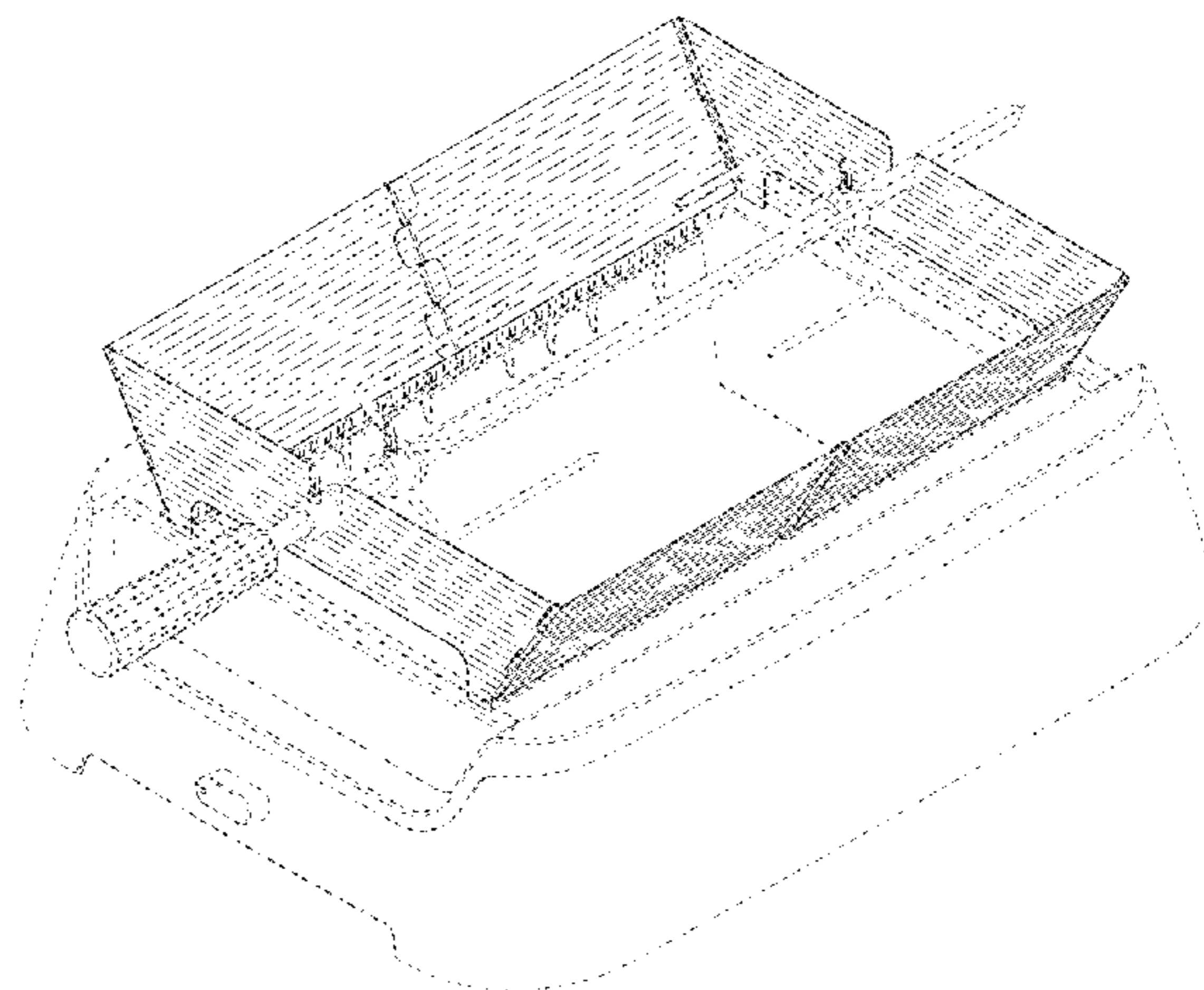
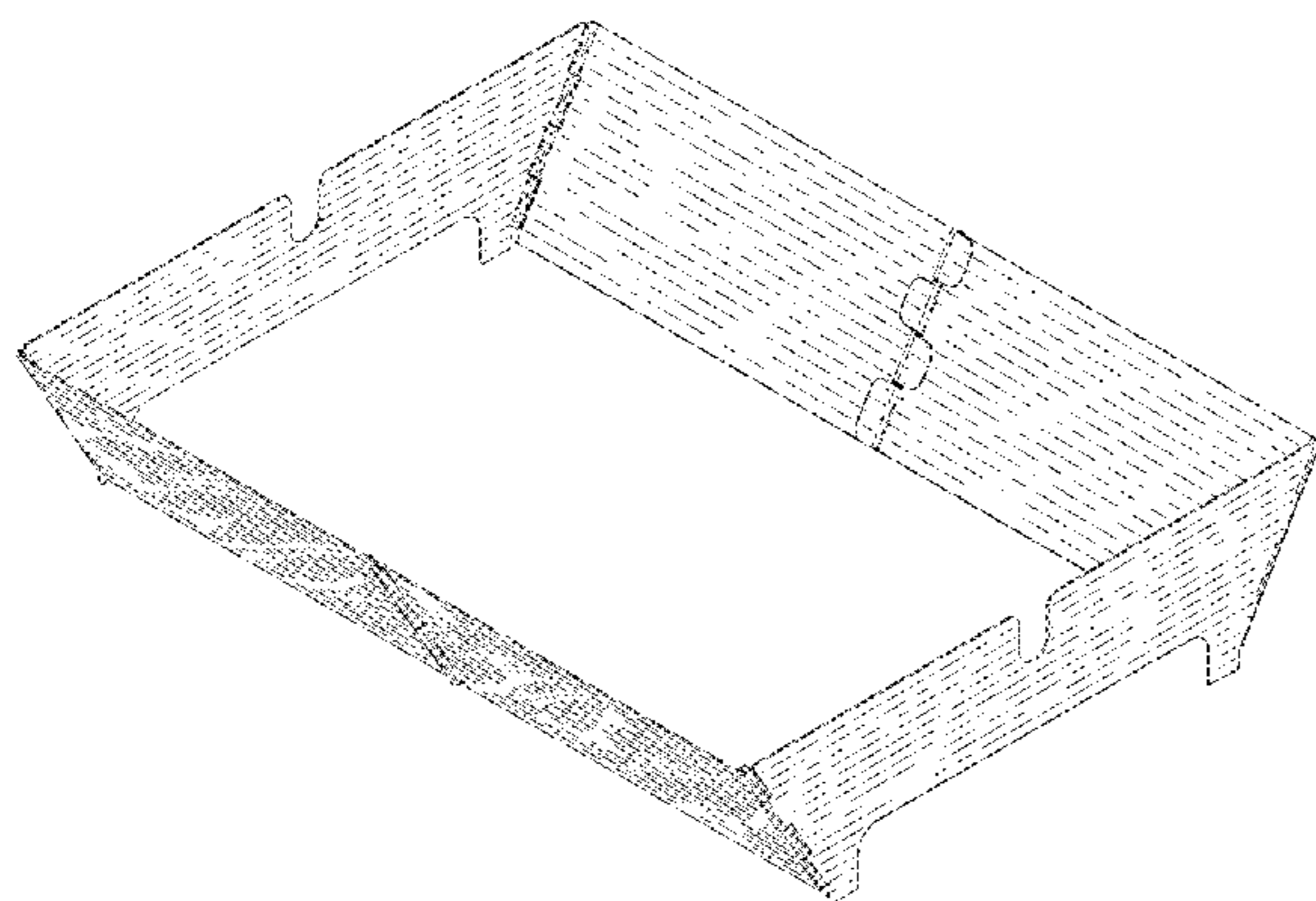

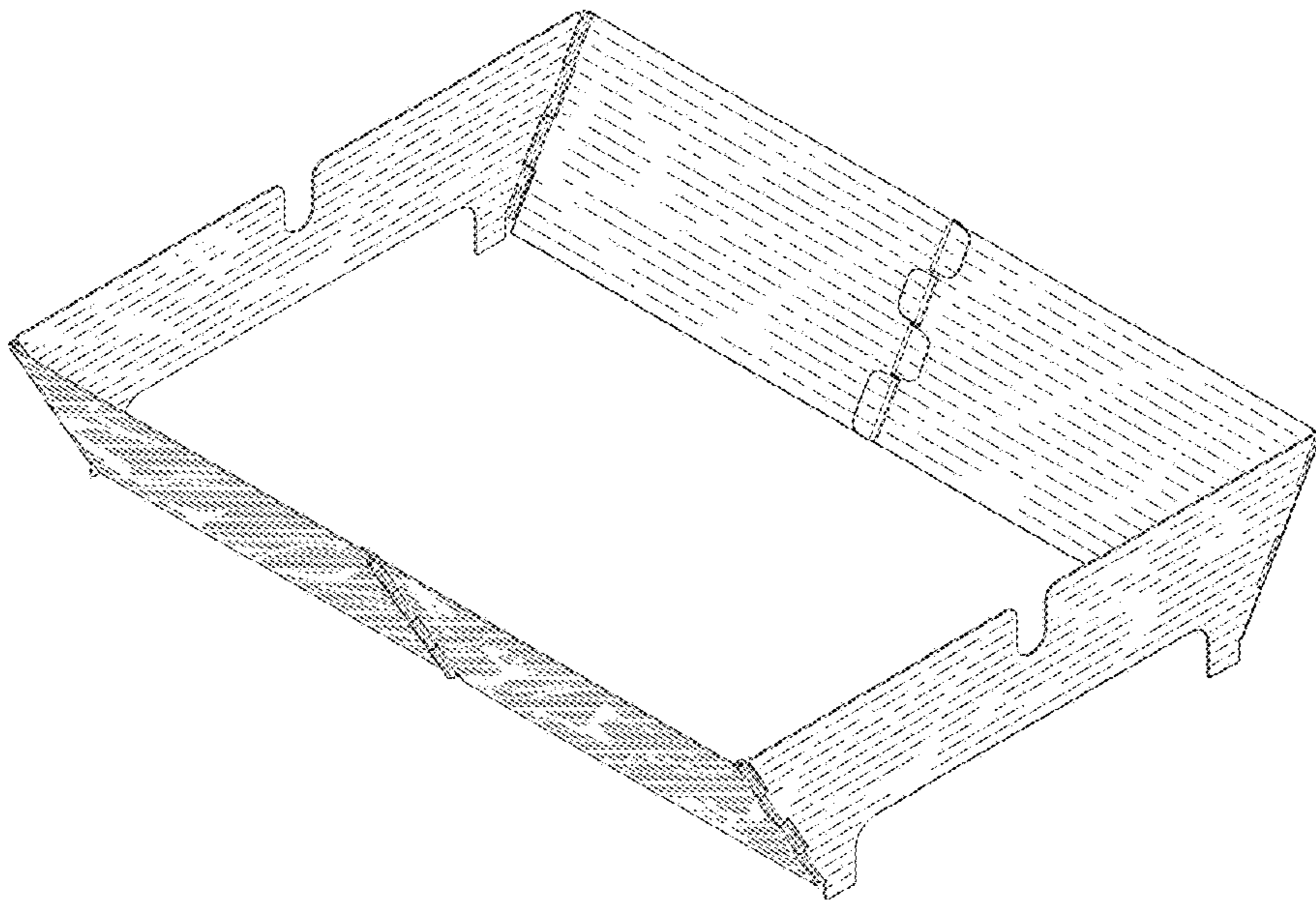

FIG. 1

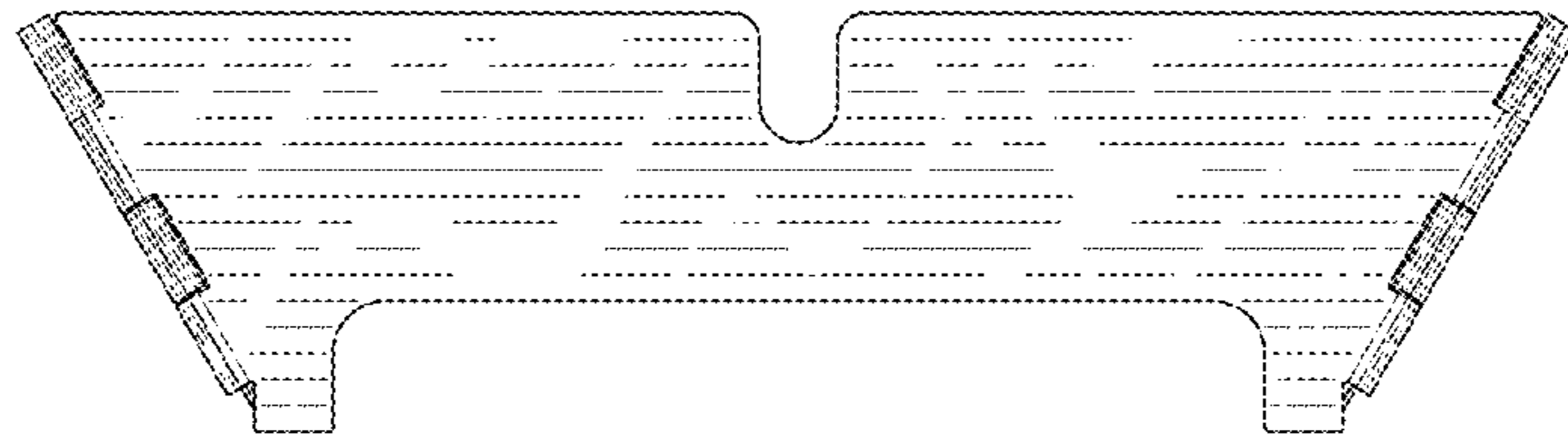

FIG. 2

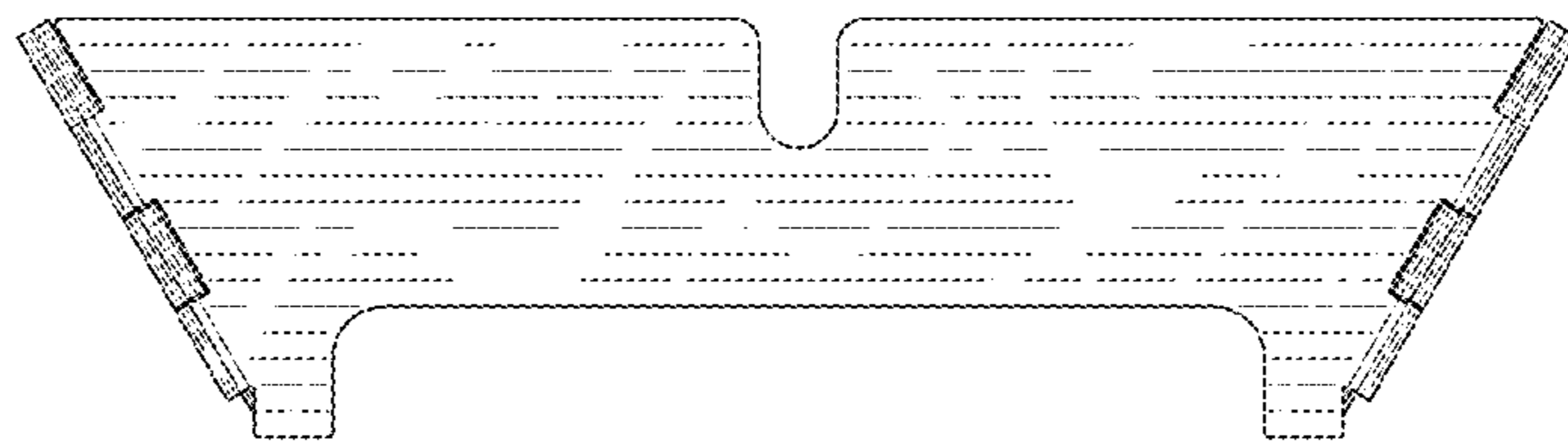

FIG. 3

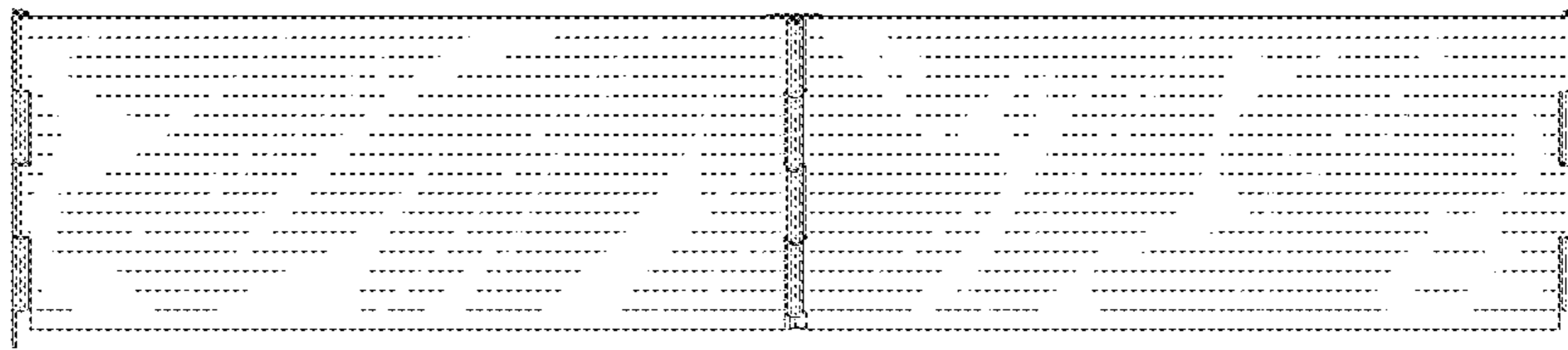

FIG. 4

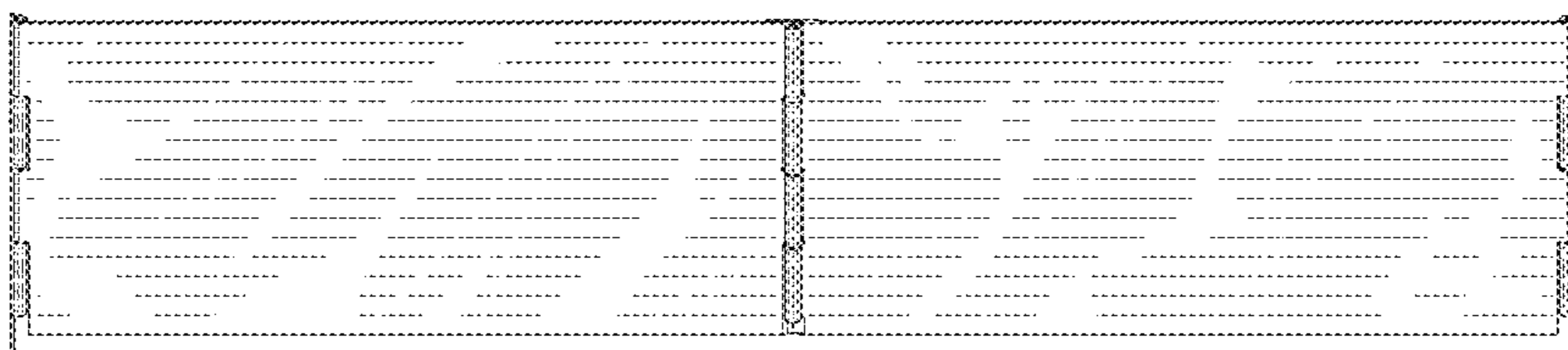

FIG. 5

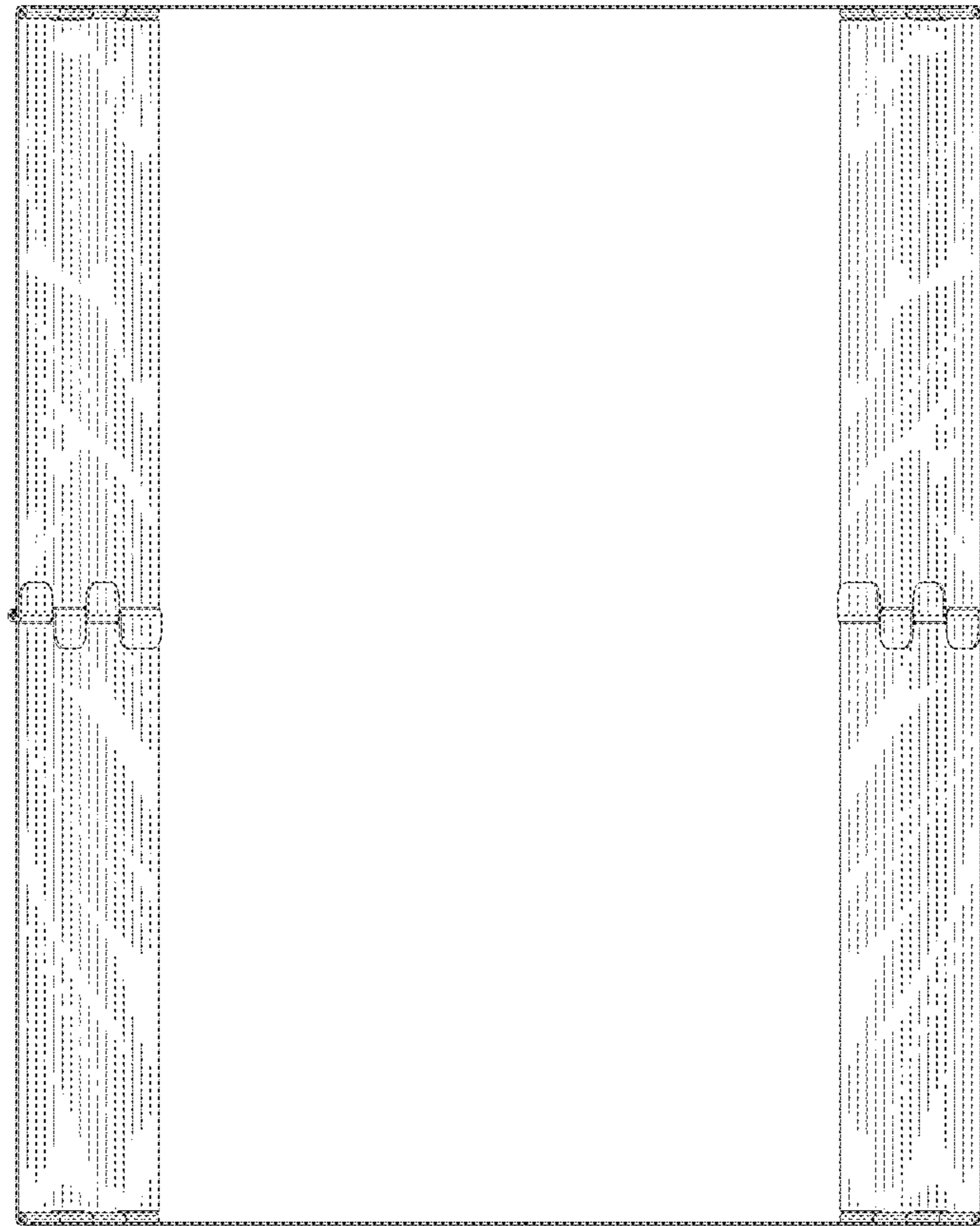

FIG. 6

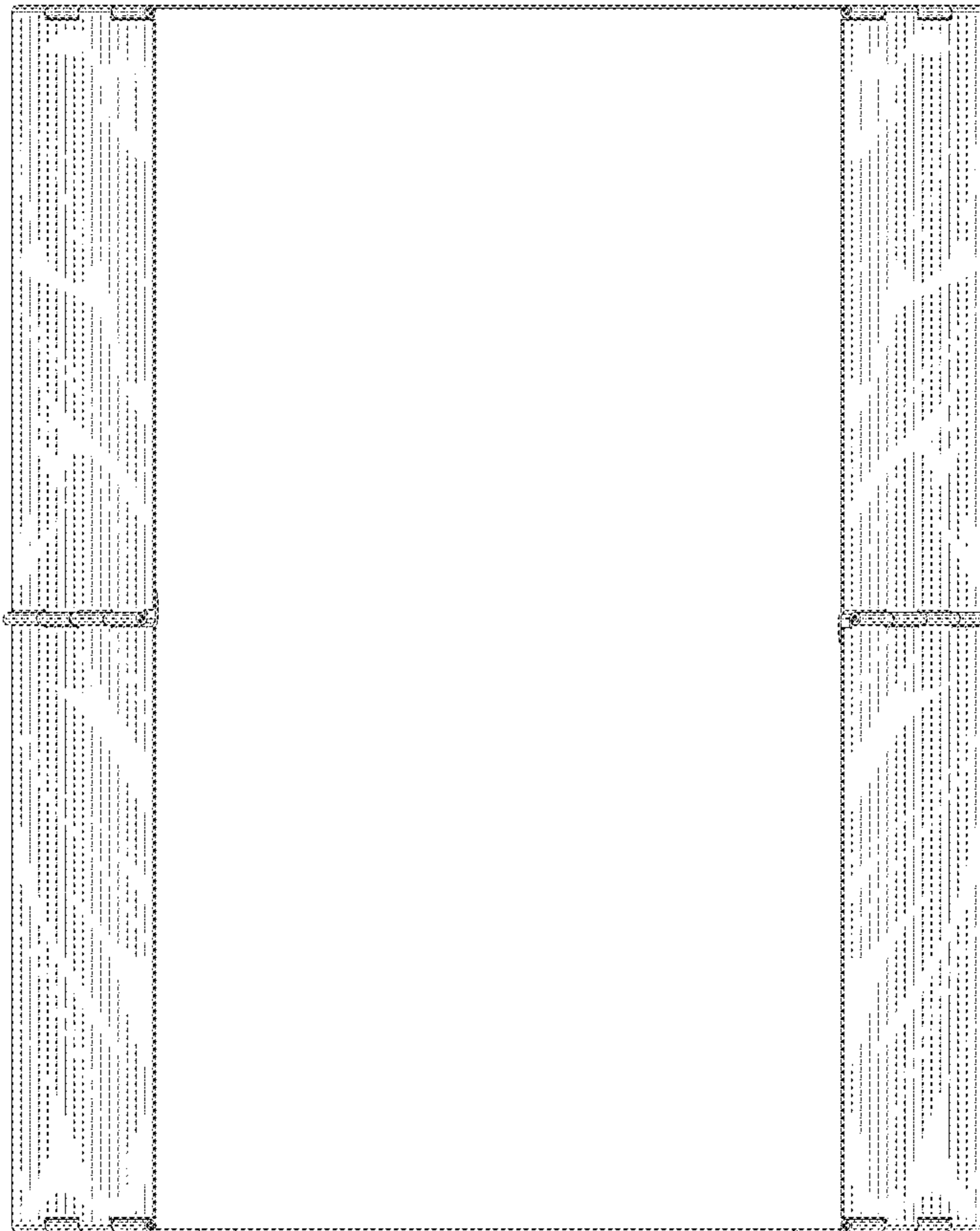

FIG. 7

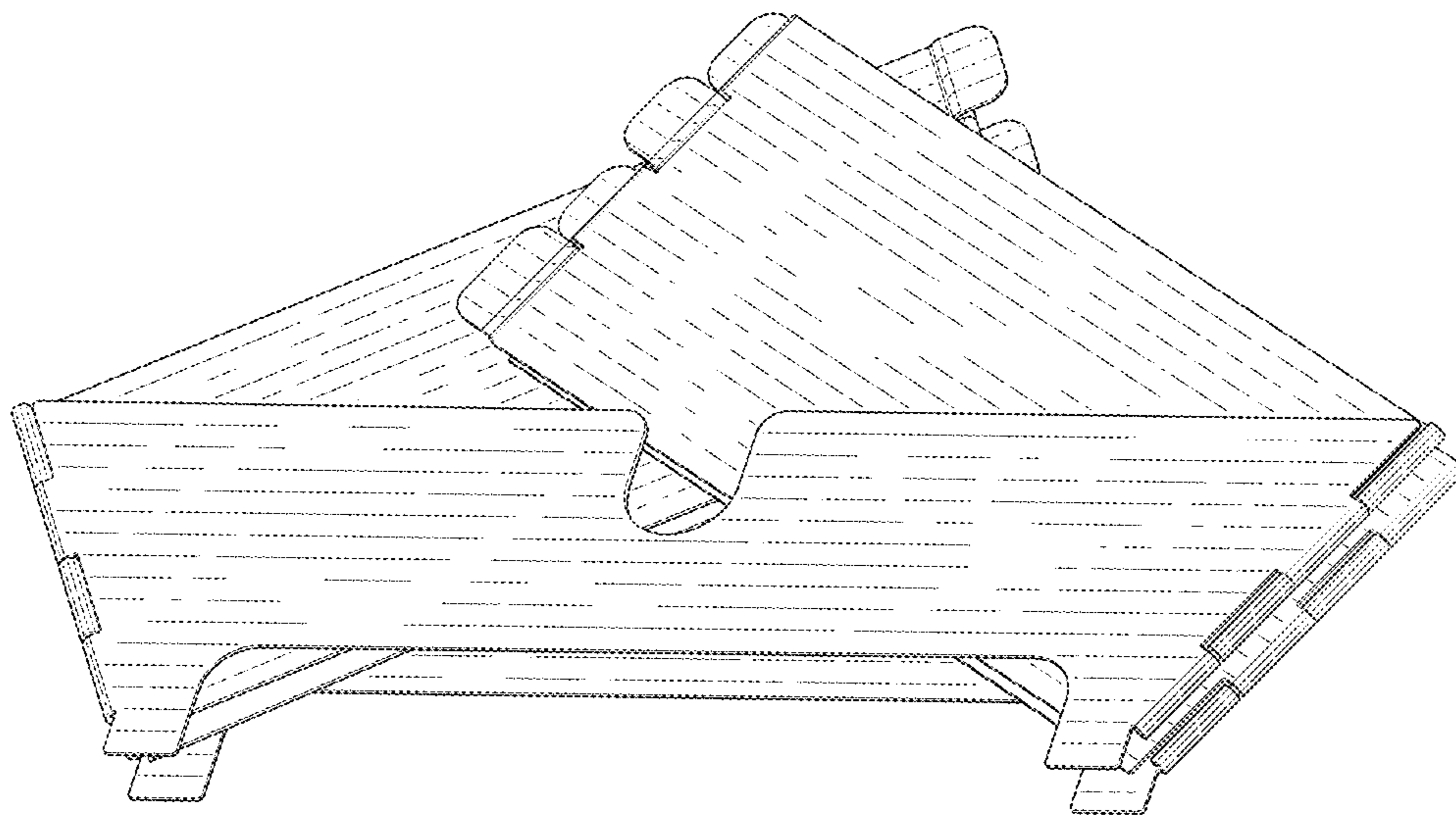

FIG. 8

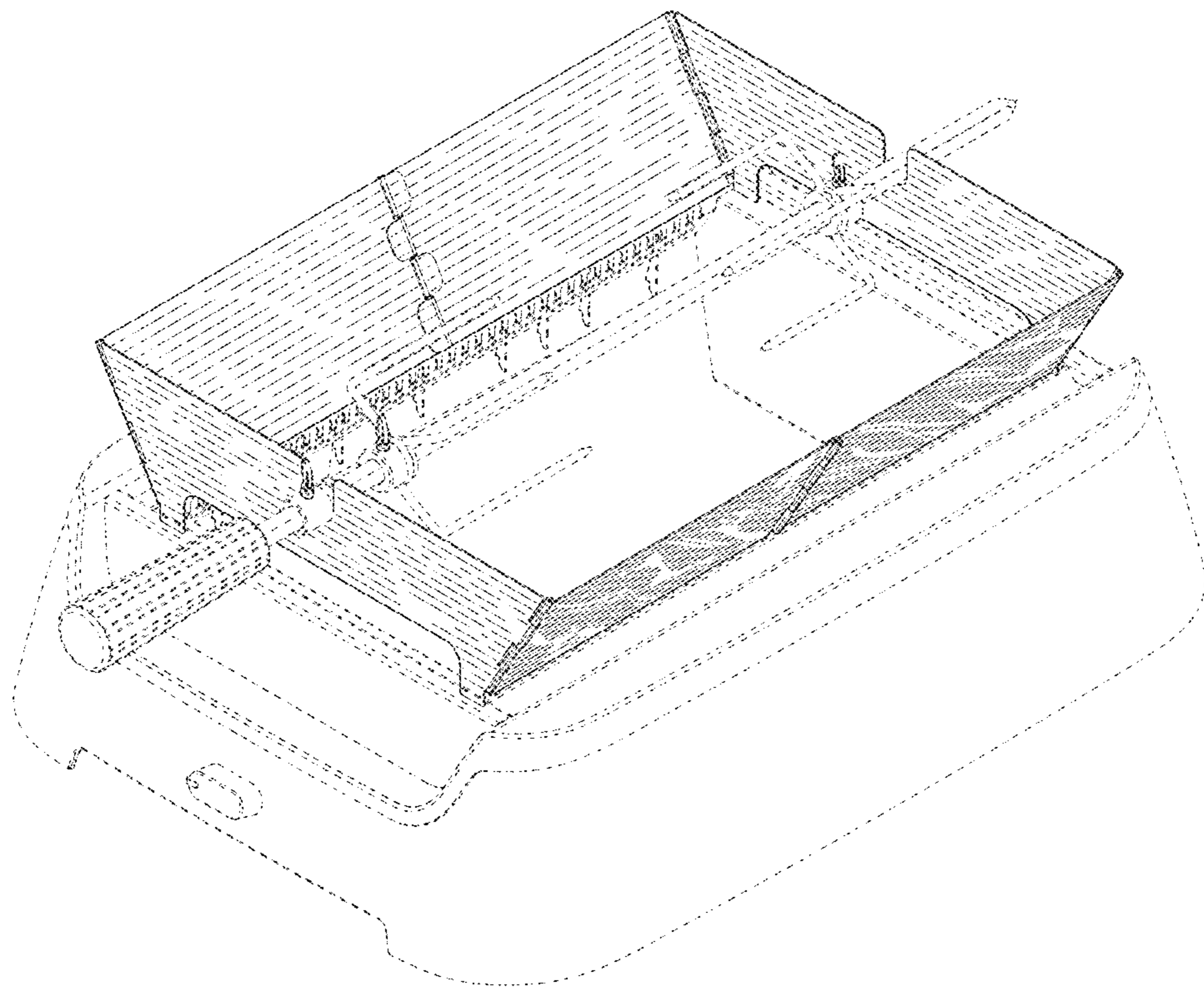

FIG. 9