

US00D860682S

(12) **United States Design Patent** (10) **Patent No.:** **US D860,682 S**
Gaetano (45) **Date of Patent:** **** Sep. 24, 2019**

(54) **ROLL-UP WINDOW COVER WITH HOOK AND LOOP FASTENERS**

(71) Applicant: **Achille Gaetano**, North Bergen, NJ (US)

(72) Inventor: **Achille Gaetano**, North Bergen, NJ (US)

(**) Term: **15 Years**

(21) Appl. No.: **29/647,549**

(22) Filed: **May 14, 2018**

(51) **LOC (12) Cl.** **06-10**

(52) **U.S. Cl.**
USPC **D6/575**

(58) **Field of Classification Search**
USPC D6/575-581; D8/358; D13/155; D25/119, 121, 123, 125; D26/138
CPC . A47H 1/02; A47H 1/04; A47H 1/144; A47H 11/06; A47H 2001/042; A47H 2023/003; A47H 2023/025; A47H 23/00; A47H 23/01; A47H 23/02; A47H 3/02; A47H 3/06; A47H 3/08; A47H 3/10; A47H 5/00; A47H 5/03; A47H 5/032; A47H 5/06; A47H 5/08; E06B 2009/2622; E06B 2009/285; E06B 9/26; E06B 9/262; E06B 9/30; E06B 9/302; E06B 9/306; E06B 9/307; E06B 9/322; E06B 9/323; E06B 9/324; E06B 9/386; E06B 9/388; E06B 9/40; E06B 9/42; E06B 9/521; E06B 9/56; E06B 9/60; E06B 9/78

See application file for complete search history.

(56) **References Cited**

U.S. PATENT DOCUMENTS

- 1,615,931 A * 2/1927 Cann F01P 7/10
160/239
- 4,372,364 A * 2/1983 Katz E06B 7/28
150/154
- 5,193,602 A * 3/1993 Morales B60P 3/343
160/243

- 5,996,674 A * 12/1999 Gatewood A47H 13/14
160/113
- 7,805,897 B2 * 10/2010 Holland E06B 9/02
160/108
- D637,853 S * 5/2011 Ehram D6/575
- D728,264 S 5/2015 Bacolas
- D735,073 S * 7/2015 Skinner D11/165
- 9,345,357 B1 * 5/2016 Davila, Jr. A47H 1/00
- D789,244 S * 6/2017 Skinner D11/165
- D789,246 S * 6/2017 Skinner D11/165
- D798,767 S * 10/2017 Skinner D11/165

(Continued)

OTHER PUBLICATIONS

“ALP Lockdown Shades—Most Secure Classroom Blackout Shade” by ALP Sewing. Accessed on Jun. 6, 2019 (Year: 2019).*

(Continued)

Primary Examiner — Kevin K Rudzinski
Assistant Examiner — Clare Ann Gannon
(74) *Attorney, Agent, or Firm* — Michael J. Feigin, Esq.; Feigin and Fridman LLC

(57) **CLAIM**

The ornamental design for a roll-up window cover with hook and loop fasteners, as shown and described.

DESCRIPTION

FIG. 1 shows a front and side perspective view of a roll-up window cover with hook and loop fasteners.
FIG. 2 shows a front elevation view thereof.
FIG. 3 shows a rear elevation view thereof.
FIG. 4 shows a right side view thereof.
FIG. 5 shows a left side view thereof.
FIG. 6 shows a top plan view thereof.
FIG. 7 shows a bottom plan view thereof; and,
FIG. 8 shows a top and side perspective view of the window cover in a rolled-up configuration.
The broken lines in the drawings represents stitching, which form a part of the claim.

1 Claim, 5 Drawing Sheets

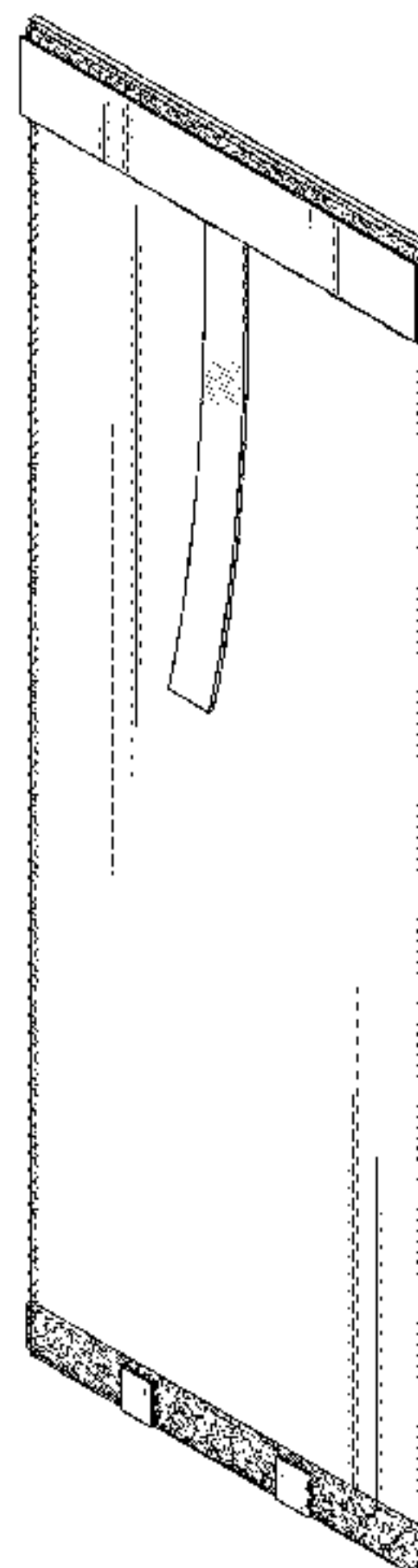

(56)

References Cited

U.S. PATENT DOCUMENTS

2005/0092448 A1 5/2005 Lin
 2006/0115620 A1* 6/2006 Anderson A47H 23/04
 428/99
 2007/0062136 A1* 3/2007 Kim E06B 3/7001
 52/311.2
 2010/0155001 A1* 6/2010 Bolton E06B 7/28
 160/368.1
 2010/0212789 A1* 8/2010 De La Croix A47H 99/00
 150/154
 2010/0263808 A1 10/2010 Hanley et al.
 2010/0326485 A1* 12/2010 Li E04H 15/16
 135/122
 2014/0251559 A1* 9/2014 Loper E06B 9/42
 160/323.1
 2014/0352899 A1* 12/2014 Moolenbeek E06B 9/40
 160/368.1
 2015/0259973 A1* 9/2015 Beaudoin E06B 9/04
 49/394
 2016/0362933 A1* 12/2016 Mueller E06B 9/00
 2019/0100959 A1* 4/2019 Chang E06B 9/262

OTHER PUBLICATIONS

“Guardian Lockdown Window Shade” by Guardian. Sold by School Specialty. . Accessed on Jun. 6, 2019 (Year: 2019).*
 “How To Install The Hideaway Helper”. By School Safety Solutions LLC. Vimeo video. . Accessed on Jun. 6, 2019 (Year: 2019).*

Media Tweets by School Safety Solution LLC (@HideawayHelper). Twitter.com. Multiple dates starting in Mar. 17, 2014. . Accessed on Jun. 6, 2019. (Year: 2014).*
 Lockdown Shades for Classroom Doors by GoldenThimble Designs. Etsy.com. . Accessed on Jun. 6, 2019 (Year: 2019).*
 Gallery—Threaded Needle by Brinda, Corporation. . Accessed on Jun. 6, 2019. (Year: 2019).*
 “10 Best Organizing Tips for the Classroom.” Rockin Resources. Aug. 10, 2014. . Accessed on Jun. 6, 2019. (Year: 2014).*
 Hook & Loop Tape [online]. Retrieved on Jul. 30, 2018 from the Internet. <URL: <https://web.archive.org/web/20130101211538/http://www.blackoutez.com:80/Hook-Loop-Tape-For-Blackout-EZ-Window-Covers/>>.
 Choose Your Window Size—TempShield For Schools [online]. Retrieved on Jul. 30, 2018 from the Internet: <URL: <http://tempshieldschools.com:80/choose-your-window-size/>>.
 Custom Blackout EZ WindowCover [online]. Retrieved on Jul. 30, 2018 from the Internet: <URL: <https://web.archive.org/web/20130101212022/http://www.blackoutez.com/Custom-Sizes/Custom-Blackout-EZ-Window-Cover/>>.
 Citizen Scientist, Roman Shades For Classroom Windows [online]. Retrieved on Jul. 30, 2018 from the Internet: <URL: <https://www.instructables.com/id/Roman-Shades-for-Classroom-Windows/>>.
 Velcro Option—TempShield for Schools [online]. Retrieved on Jul. 30, 2018 from the Internet: <URL: <http://tempshieldschools.com:80/velcro-mounting/>>.

* cited by examiner

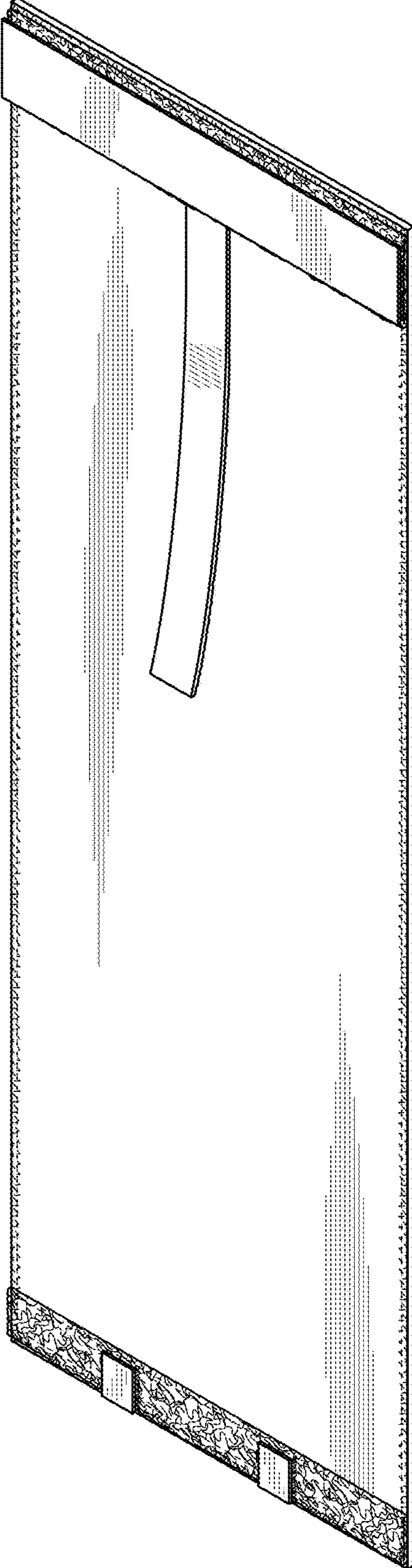

FIG. 1

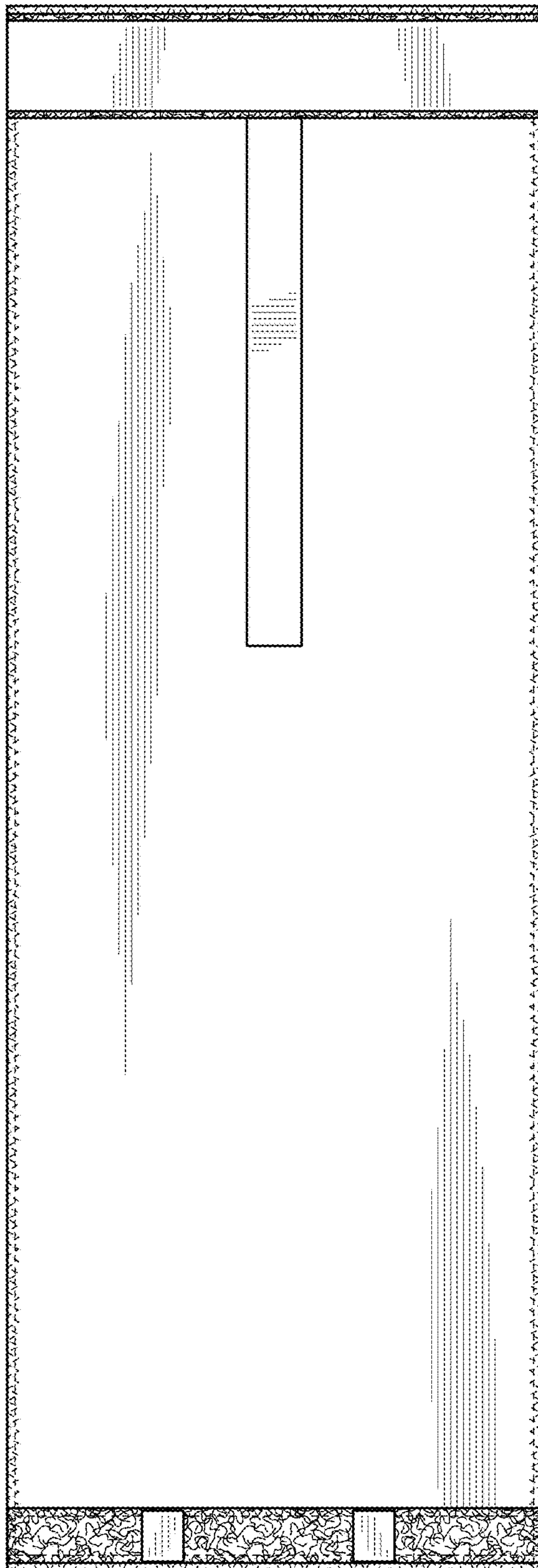

FIG. 2

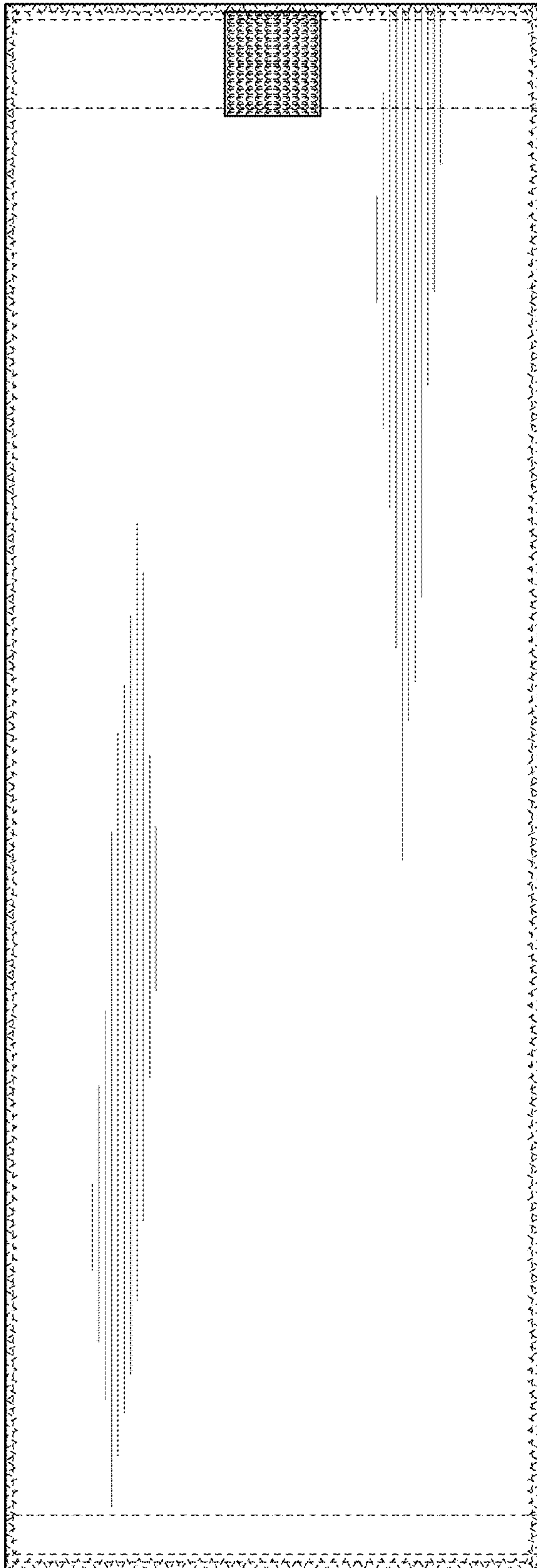
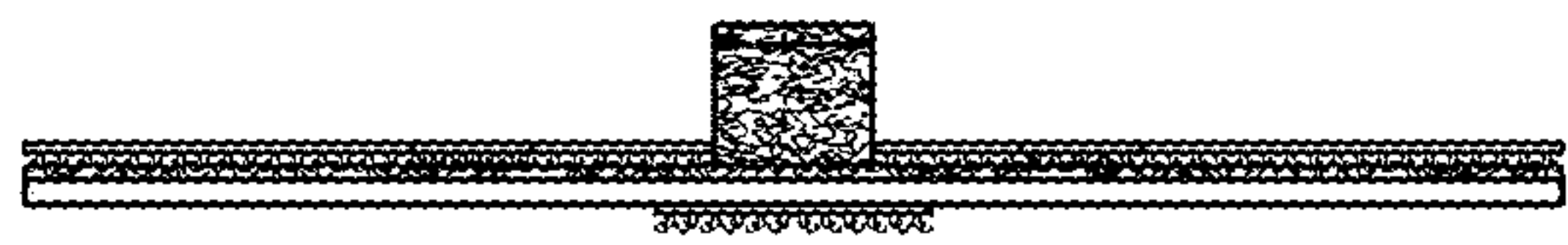
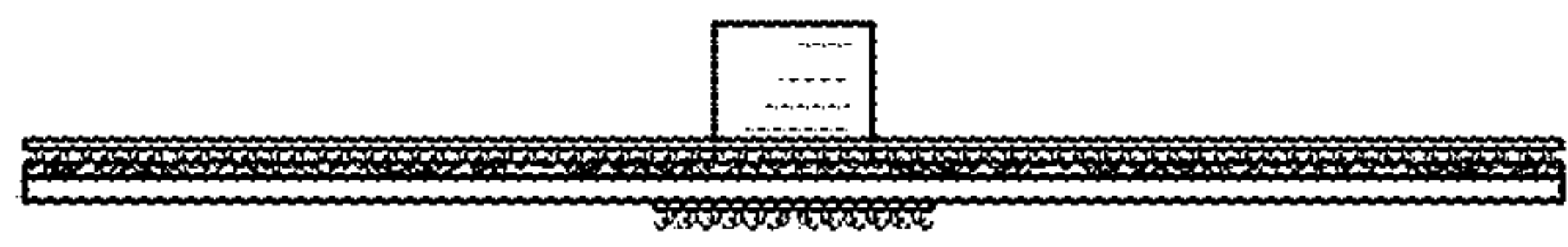
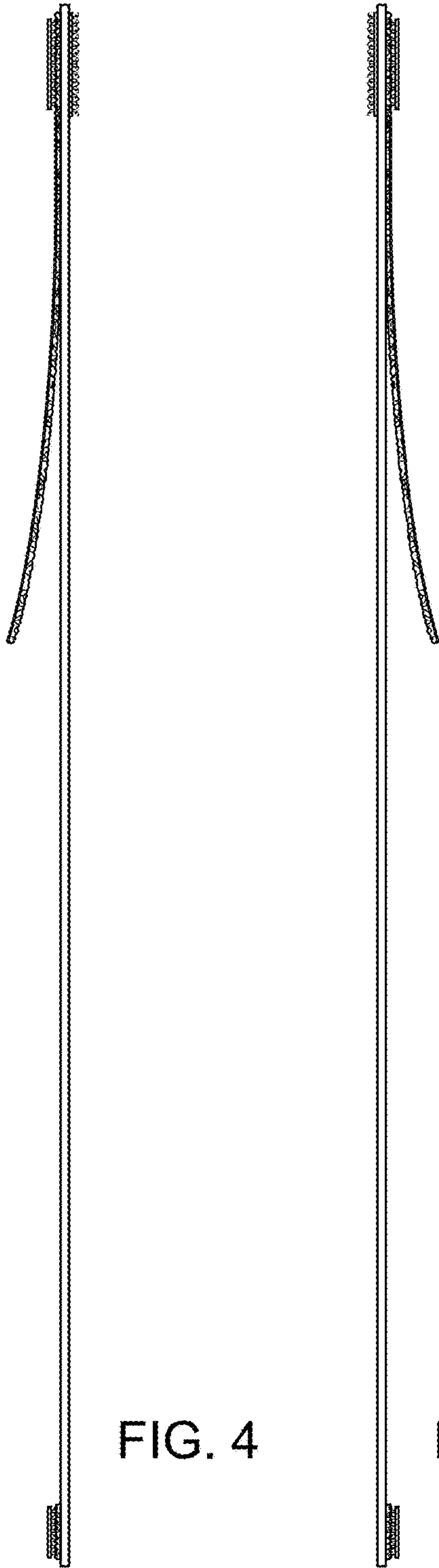

FIG. 3



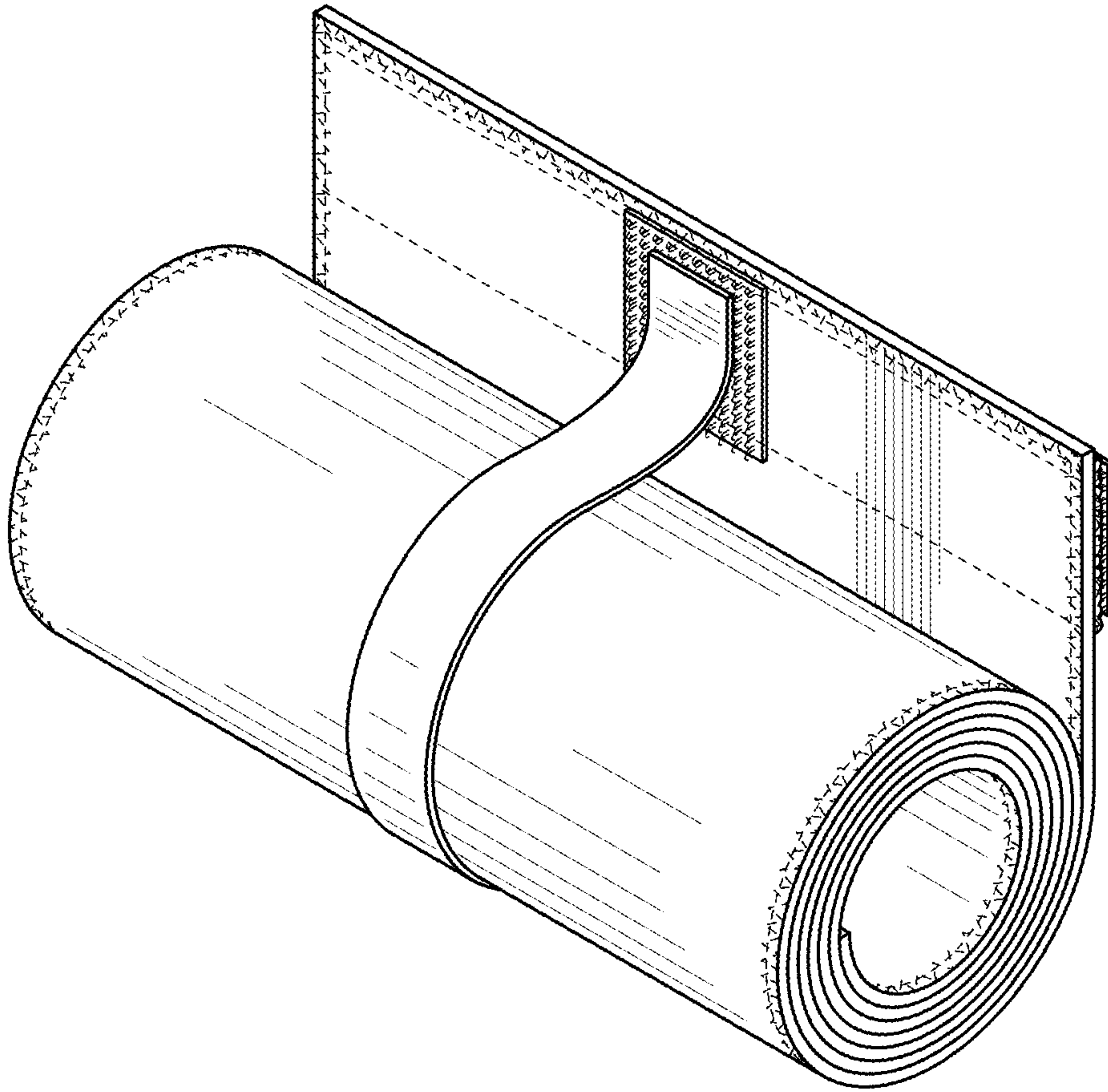

FIG. 8