



US00D860639S

(12) **United States Design Patent** (10) **Patent No.:** **US D860,639 S**
Thibadeau (45) **Date of Patent:** **** Sep. 24, 2019**

(54) **BAG**
(71) Applicant: **Thule, Inc.**, Seymour, CT (US)
(72) Inventor: **Mark Thibadeau**, Boulder, CO (US)
(73) Assignee: **Thule, Inc.**, Seymour, CT (US)
(**) Term: **15 Years**

D734,948 S 7/2015 Farrelly
D745,777 S 12/2015 Zwetzig et al.
D748,910 S * 2/2016 Ford D3/217
D759,369 S 6/2016 Mei Yee
9,642,443 B2 5/2017 Amago
D819,328 S * 6/2018 Muhlenkamp, IV D3/217
D831,952 S * 10/2018 Pennington D3/217
D836,326 S * 12/2018 Skaff D3/217
D843,714 S * 3/2019 Sheikh D3/217

(Continued)

(21) Appl. No.: **29/679,998**
(22) Filed: **Feb. 12, 2019**

Related U.S. Application Data

(63) Continuation of application No. 29/605,502, filed on May 26, 2017, now Pat. No. Des. 840,682.
(51) **LOC (12) Cl.** **03-01**
(52) **U.S. Cl.**
USPC **D3/217**
(58) **Field of Classification Search**
USPC D3/201, 215, 216, 217, 218, 222, 273,
D3/276, 284, 285, 289, 290, 291, 900
CPC A45C 3/02; A45C 2003/008; A45C 5/03;
A45C 2011/003; A45C 5/00; A45C
2005/032; A45C 5/08; A45C 5/14; A45F
3/04

See application file for complete search history.

(56) **References Cited**

U.S. PATENT DOCUMENTS

D448,160 S 9/2001 Sijmons et al.
D449,162 S 10/2001 Sijmons et al.
D511,620 S 11/2005 Van Himbeeck
D603,163 S 11/2009 Van Himbeeck
D641,973 S 7/2011 Quehl
D674,591 S 1/2013 Hargens et al.
D706,534 S 6/2014 Zwetzig
D708,845 S 7/2014 Taylor
D709,689 S 7/2014 Brunazzi et al.

OTHER PUBLICATIONS

Amazon, "Thule Subterra Backpack 34L", First reviewed on Apr. 24, 2017. (<https://www.amazon.com/Thule-3203442-Subterra-Backpack-34L/dp/B079C97DTV>) (Year: 2017).*

(Continued)

Primary Examiner — Jennifer Rivard

Assistant Examiner — April Rivas

(74) *Attorney, Agent, or Firm* — Sterne, Kessler, Goldstein & Fox P.L.L.C.

(57) **CLAIM**

The ornamental design for a bag, as shown and described.

DESCRIPTION

FIG. 1 is a top front perspective view of a bag showing the claimed design;

FIG. 2 is a front view thereof;

FIG. 3 is a rear view thereof;

FIG. 4 is a right side view thereof;

FIG. 5 is a left side view thereof;

FIG. 6 is a top view thereof; and,

FIG. 7 is a bottom view thereof.

The broken lines in the figures show portions of the bag that form no part of the claimed design.

The hatched lines in the figures show shading and not surface ornamentation.

1 Claim, 7 Drawing Sheets



(56)

References Cited

U.S. PATENT DOCUMENTS

D844,319 S * 4/2019 Tan D3/217
D844,975 S * 4/2019 Munie D3/217
2009/0283564 A1* 11/2009 Bass A45C 13/1046
224/656
2015/0034690 A1* 2/2015 Shannon A45F 3/04
224/637
2015/0351510 A1* 12/2015 Zwetzig A45C 11/38
206/316.2
2017/0196345 A1* 7/2017 Meyer A45F 3/04
2018/0116359 A1* 5/2018 Demke A45C 13/40

OTHER PUBLICATIONS

Amazon, "Arcido Faroe Backpack . . .", First on sale Sep. 27, 2016.
(<https://www.amazon.com/dp/B01N9IRMET/>) (Year: 2016).*

Thule.com, "Thule Crossover Carry-on 56cm/22"" <https://www.thule.com/en/se/luggage/carry-on-luggage/thule-crossover-carry-on-56cm22-_tl_85854224291>, accessed Aug. 24, 2017.

Thule.com, "Thule Crossover Rolling Duffel 87L" <https://www.thule.com/en/se/luggage/travel-duffel-bags/thule-crossover-rolling-duffel-87l-_tl_85854214261>, accessed Aug. 24, 2017.

Amazon, "Thule Subterra Carry-on Rolling Duffel 36L", First reviewed on May 5, 2017. (<https://www.amazon.com/Thule-Subterra-3203446-Carry-Shadow/dp/801NCM2CN7>) (Year: 2017).

* cited by examiner

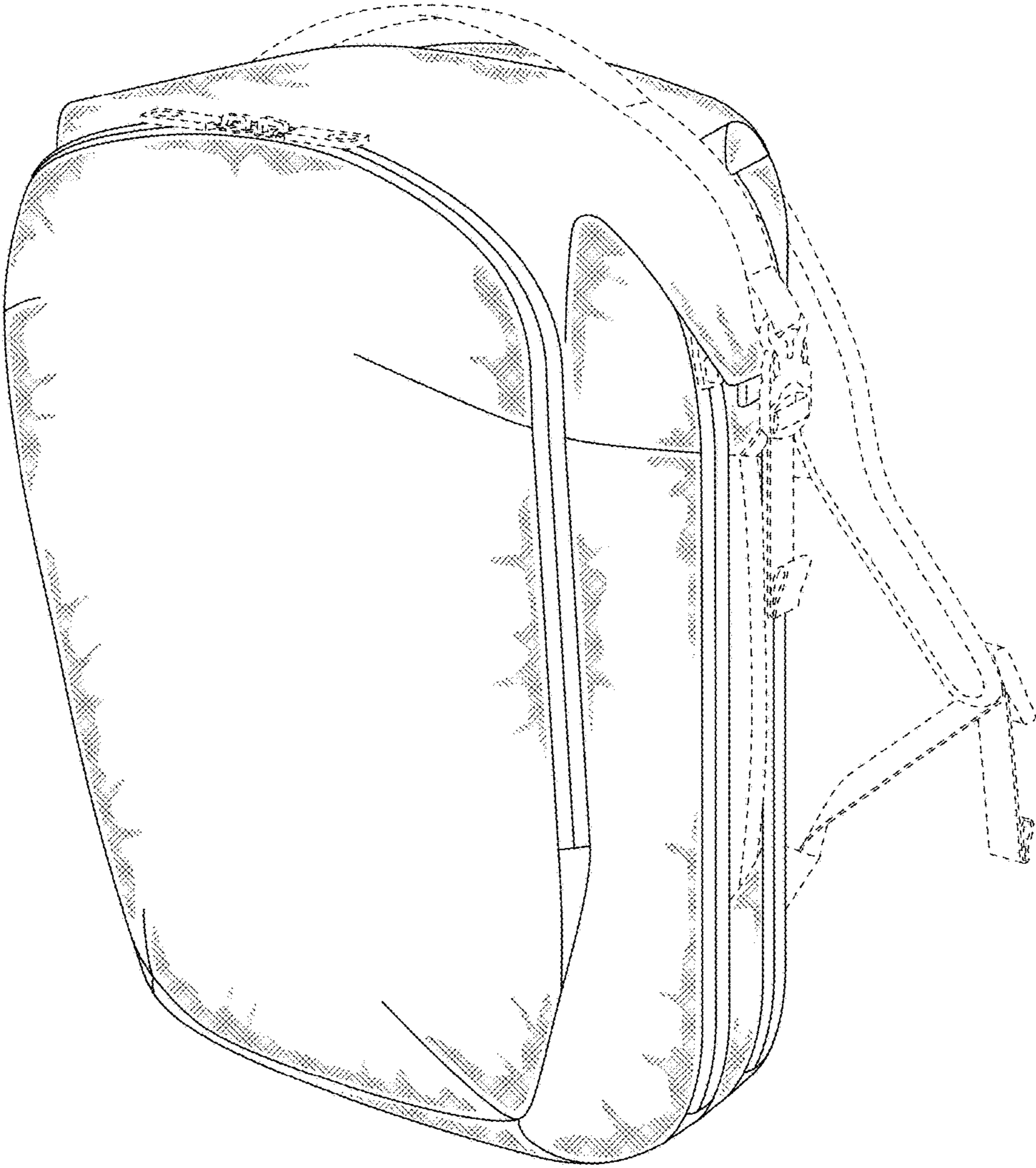

FIG. 1

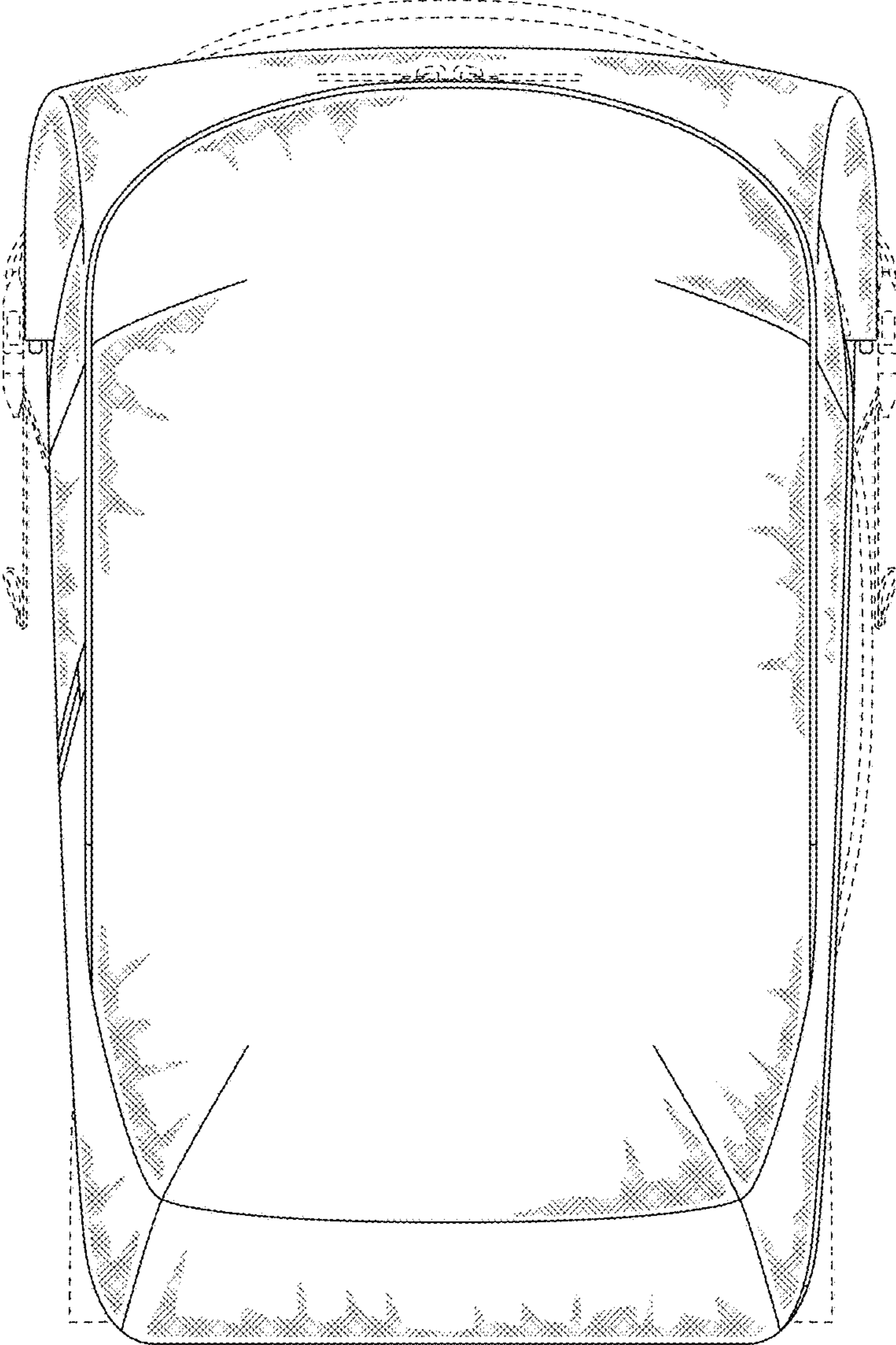

FIG. 2

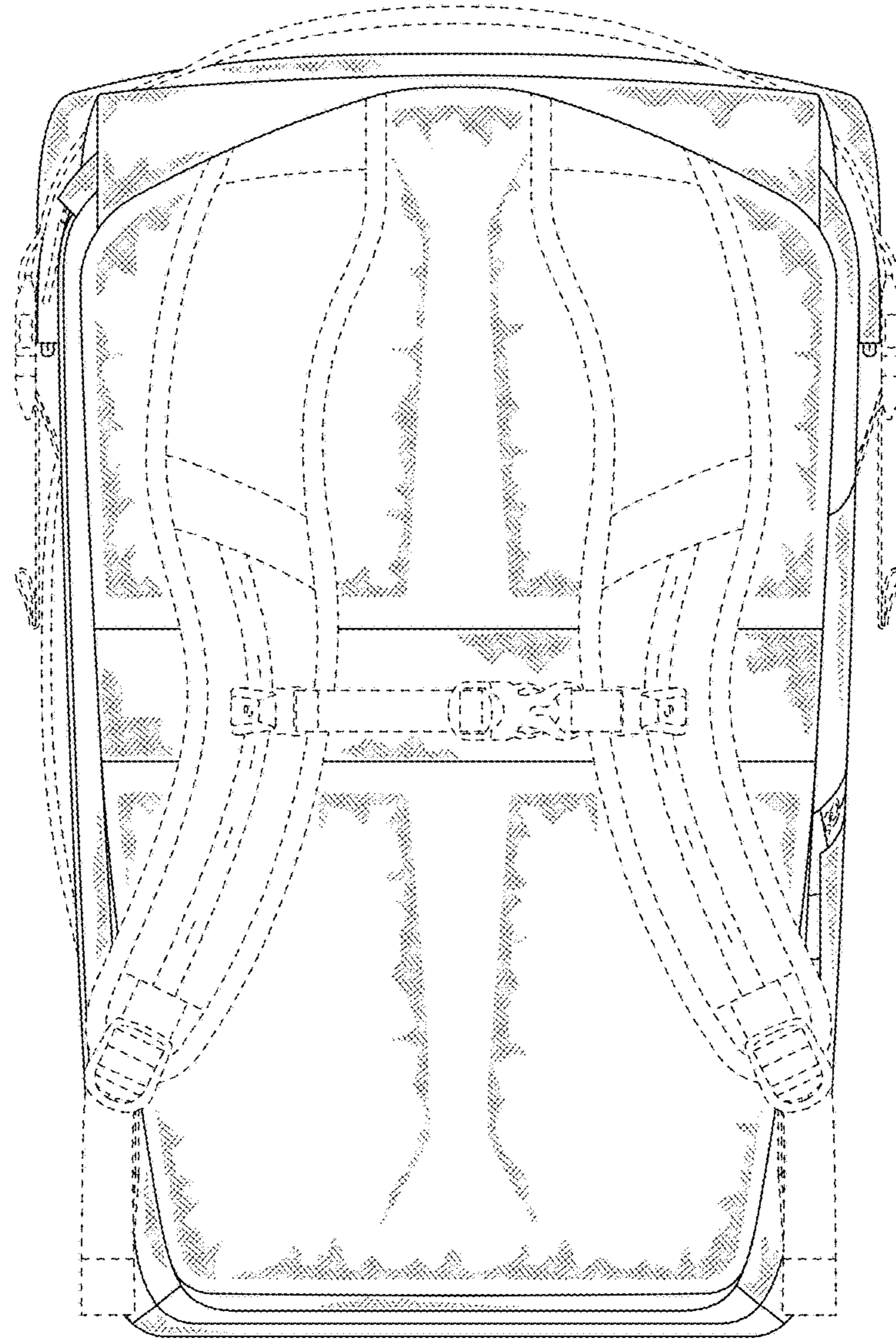

FIG. 3

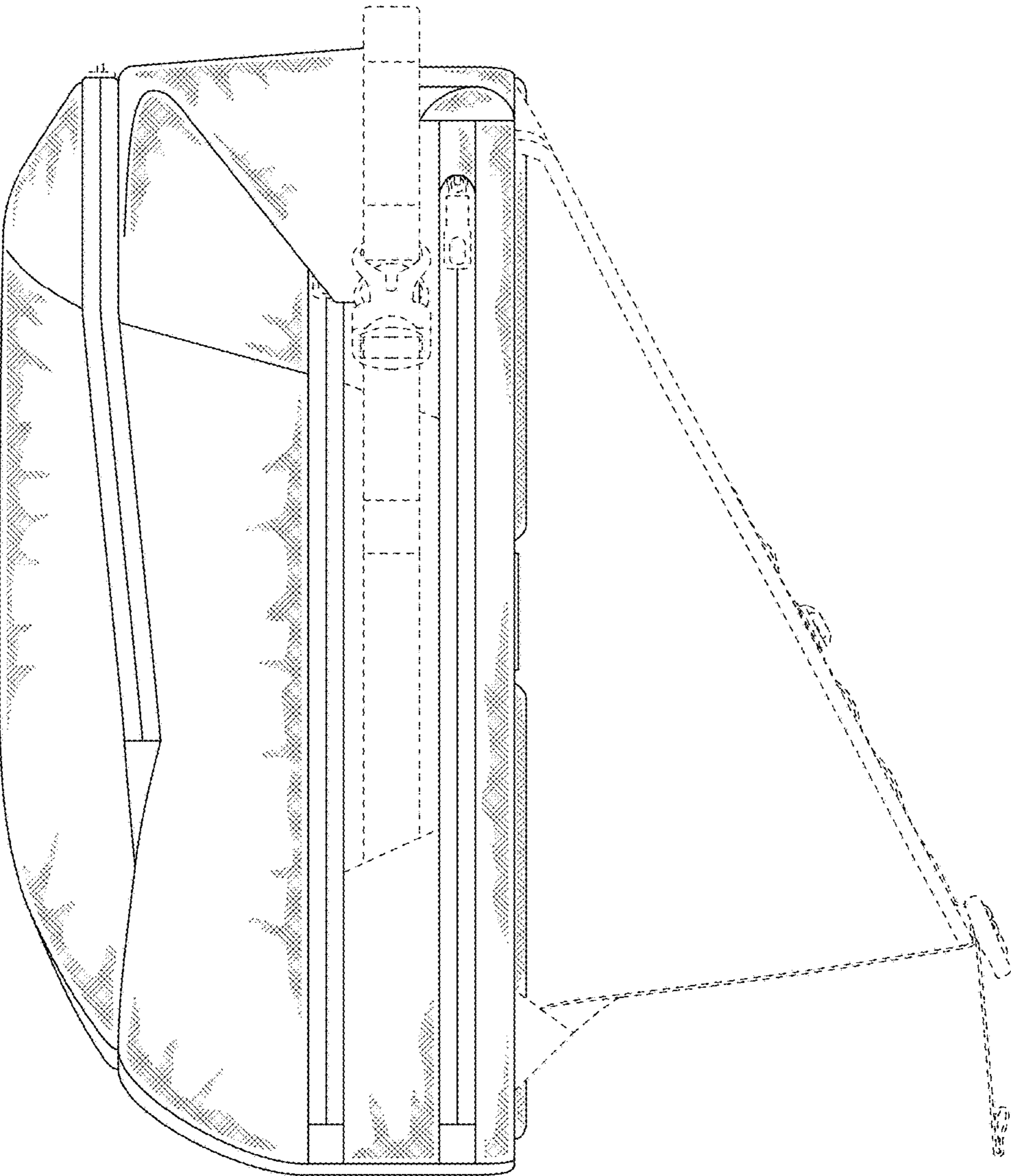

FIG. 4

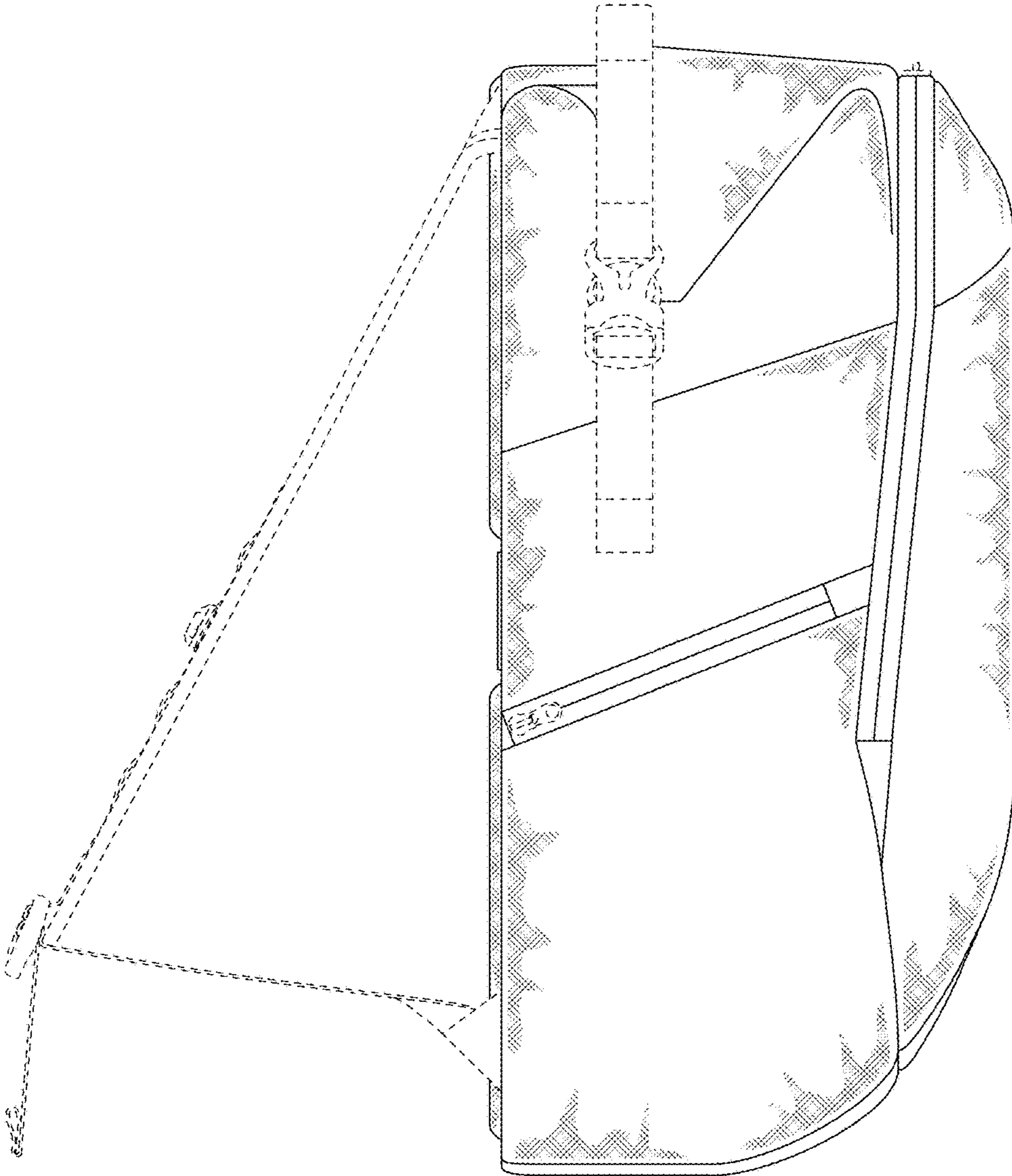

FIG. 5

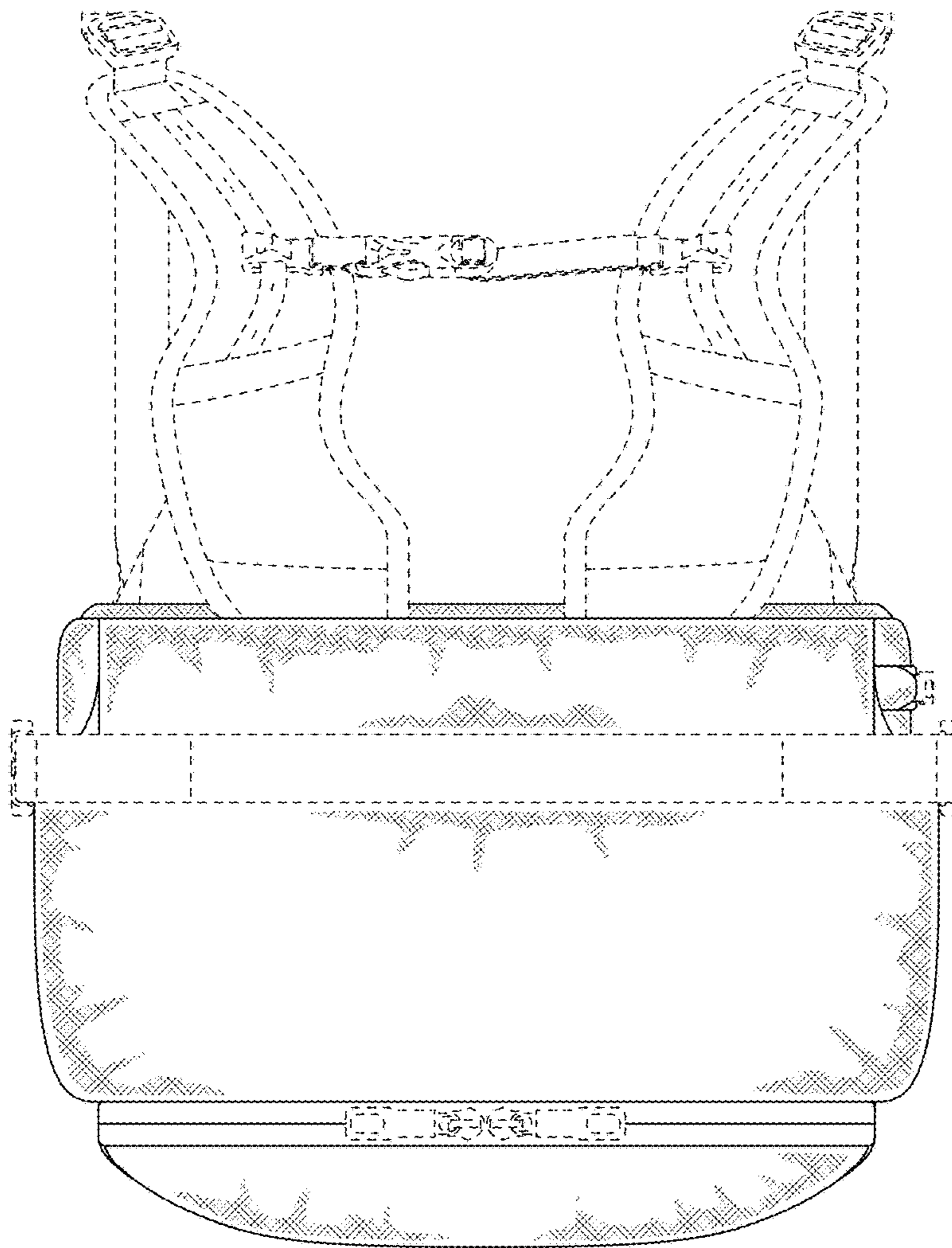

FIG. 6

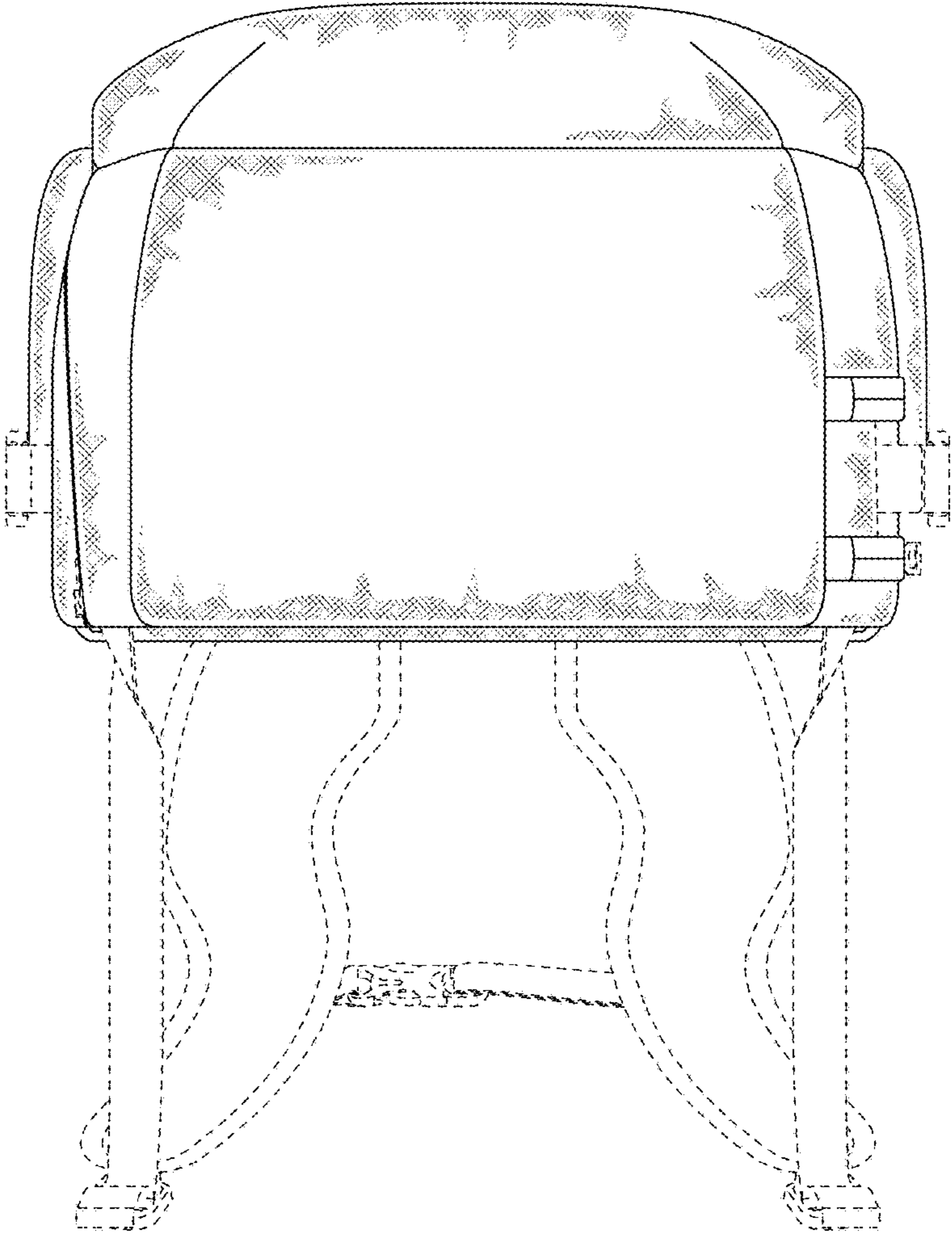

FIG. 7