



US00D860631S

(12) **United States Design Patent** (10) **Patent No.:** **US D860,631 S**
Thomas (45) **Date of Patent:** **** Sep. 24, 2019**

- (54) **ROTATABLE NEEDLEWORK FRAME**
- (71) Applicant: **Julie Thomas**, Evans Mills, NY (US)
- (72) Inventor: **Julie Thomas**, Evans Mills, NY (US)
- (73) Assignee: **THE OLD TATTERED FLAG, LLC**,
Evans Mills, NY (US)
- (**) Term: **15 Years**
- (21) Appl. No.: **29/648,825**
- (22) Filed: **May 24, 2018**
- (51) **LOC (12) Cl.** **02-07**
- (52) **U.S. Cl.**
USPC **D3/26**
- (58) **Field of Classification Search**
USPC D3/18, 20, 21, 23, 26; D15/66
CPC D05B 21/00; D05B 21/002; D05B 21/005;
D05B 21/007; D05B 75/00; D05B 75/06;
D05B 91/10; D05C 1/02; D05C 9/04
See application file for complete search history.

(56) **References Cited**

U.S. PATENT DOCUMENTS

3,774,326 A *	11/1973	Selden	D04G 3/02
				38/102.4
3,955,722 A *	5/1976	Bard	D05C 1/04
				223/106
D244,754 S *	6/1977	Bard	289/18.1
D244,755 S *	6/1977	Bard	38/102.2
4,043,270 A *	8/1977	Miner	D06C 3/08
				38/102.91
4,175,343 A *	11/1979	Mathews	D06C 3/08
				269/51
D259,302 S *	5/1981	Davis	139/34
4,292,748 A *	10/1981	Miller	D05C 1/02
				108/43
4,322,901 A *	4/1982	Spitzke	D06C 3/08
				38/102.6

- 4,417,409 A * 11/1983 Bell D06C 3/08
38/102.91
 - D275,200 S * 8/1984 Langford D15/66
 - D276,162 S * 10/1984 Rancourt D15/66
 - 4,549,366 A * 10/1985 Gerding D05C 1/04
38/102.2
 - D281,374 S * 11/1985 Mazeika D3/26
 - D284,044 S * 6/1986 Di Martino D3/26
 - 4,658,522 A * 4/1987 Kramer B44D 3/185
160/402
 - D293,976 S * 2/1988 Dutton D3/26
- (Continued)

Primary Examiner — John Windmuller
Assistant Examiner — Steven J Czyz
 (74) *Attorney, Agent, or Firm* — Hodgson Russ LLP

(57) **CLAIM**
 The ornamental design for a rotatable needlework frame, as shown and described.

DESCRIPTION

FIG. 1 is a perspective view of a first embodiment of a rotatable needlework frame, showing my new design; FIG. 2 is a top plan view thereof; FIG. 3 is a bottom plan view thereof; FIG. 4 is a front elevation view thereof; FIG. 5 is a rear elevation view thereof; FIG. 6 is a right side elevation view thereof; FIG. 7 is a left side elevation view thereof; FIG. 8 is a perspective view of a second embodiment of a rotatable needlework frame; FIG. 9 is a top plan view thereof; FIG. 10 is a bottom plan view thereof; FIG. 11 is a front elevation view thereof; FIG. 12 is a rear elevation view thereof; FIG. 13 is a right side elevation view thereof; and, FIG. 14 is a left side elevation view thereof. The broken lines depict unclaimed features of the rotatable needlework frame that form no part of the claimed design.

1 Claim, 12 Drawing Sheets

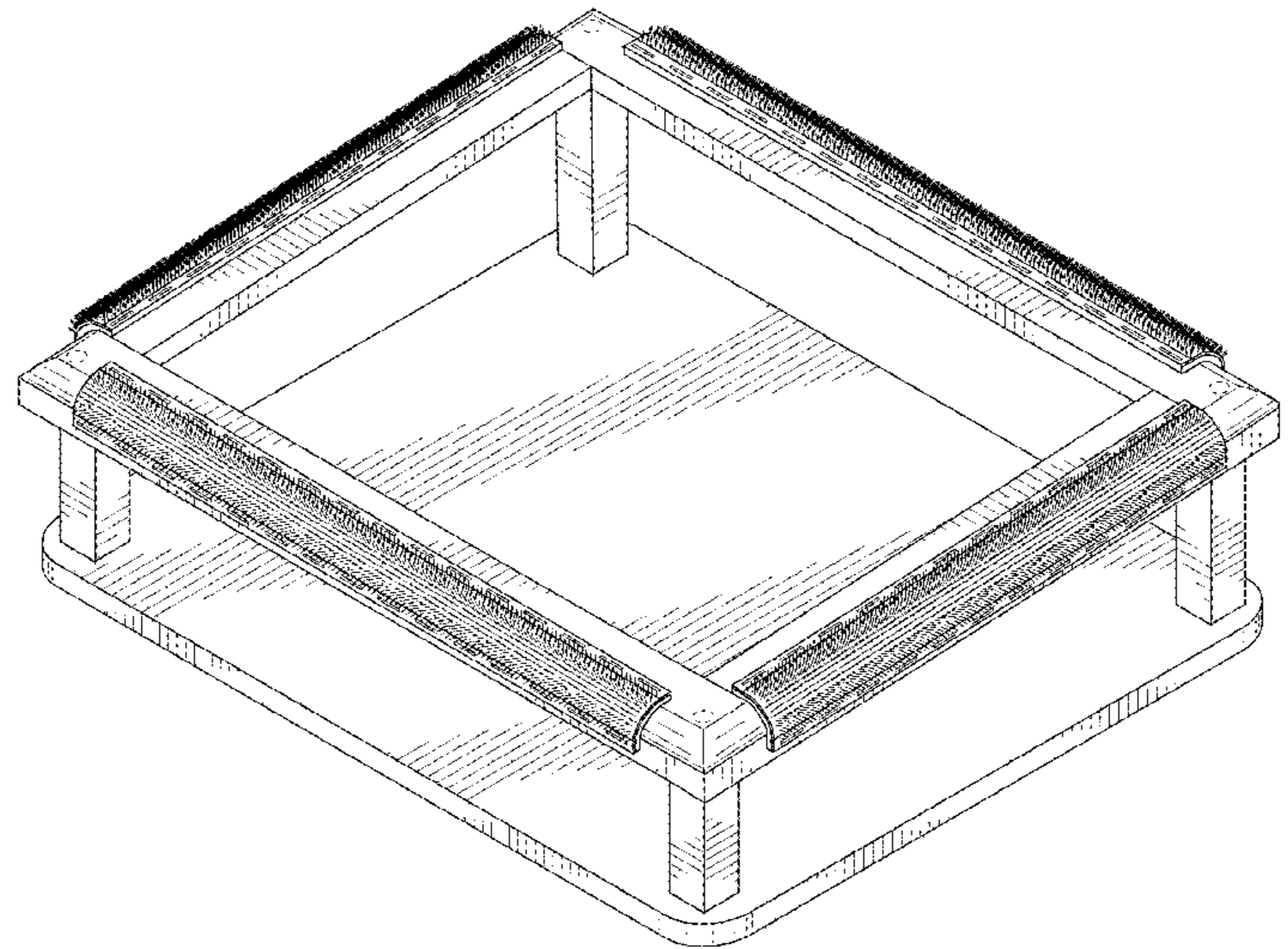

(56)

References Cited

U.S. PATENT DOCUMENTS

4,827,638 A * 5/1989 Peters D05C 1/04
108/94
D309,057 S * 7/1990 Peters D15/66
D309,058 S * 7/1990 Peters D3/26
4,944,105 A * 7/1990 Schulle D05C 1/02
38/102
D318,756 S * 8/1991 Schulle D3/18
D357,799 S * 5/1995 Wilkerson D3/26
D371,234 S * 7/1996 Hyche D3/26
6,138,965 A * 10/2000 Iorio D05C 1/04
248/148
D445,562 S * 7/2001 Bronstein D3/26
D473,371 S * 4/2003 Bronstein D3/26
D499,881 S * 12/2004 Williams D3/20
7,302,766 B2 * 12/2007 Abel D05C 1/02
38/102.21
D773,174 S * 12/2016 Okuma D3/26

* cited by examiner

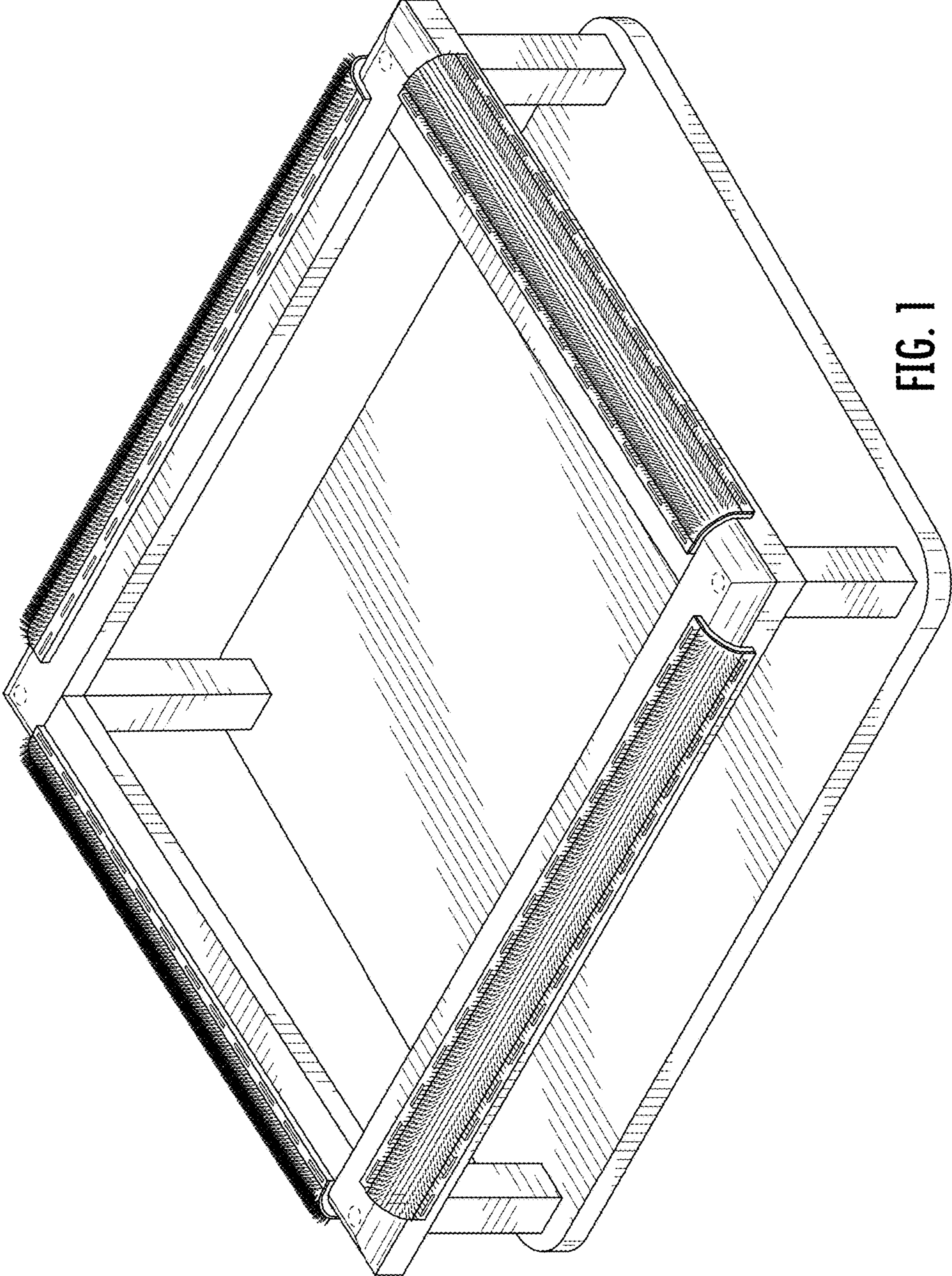

FIG. 1

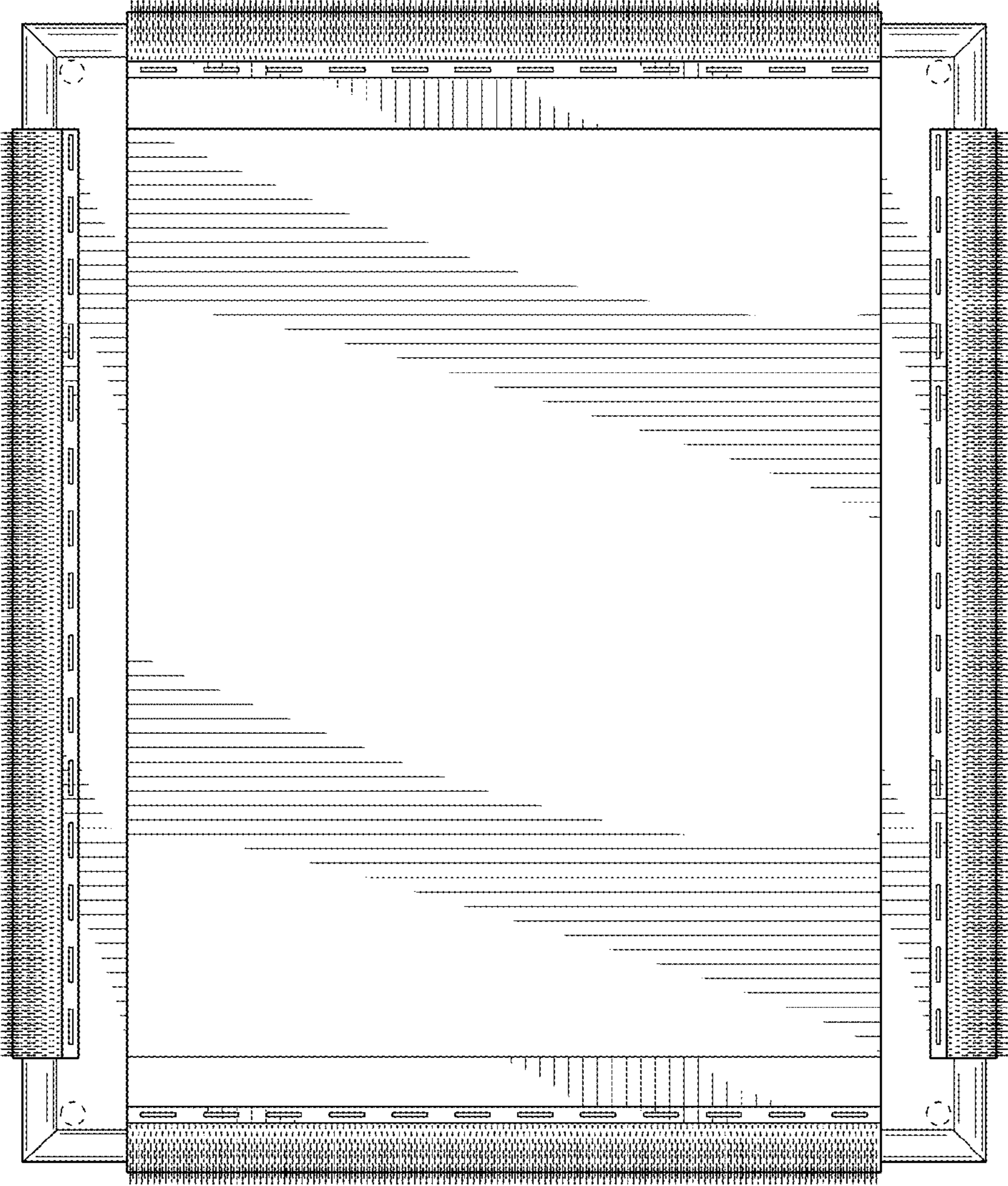

FIG. 2

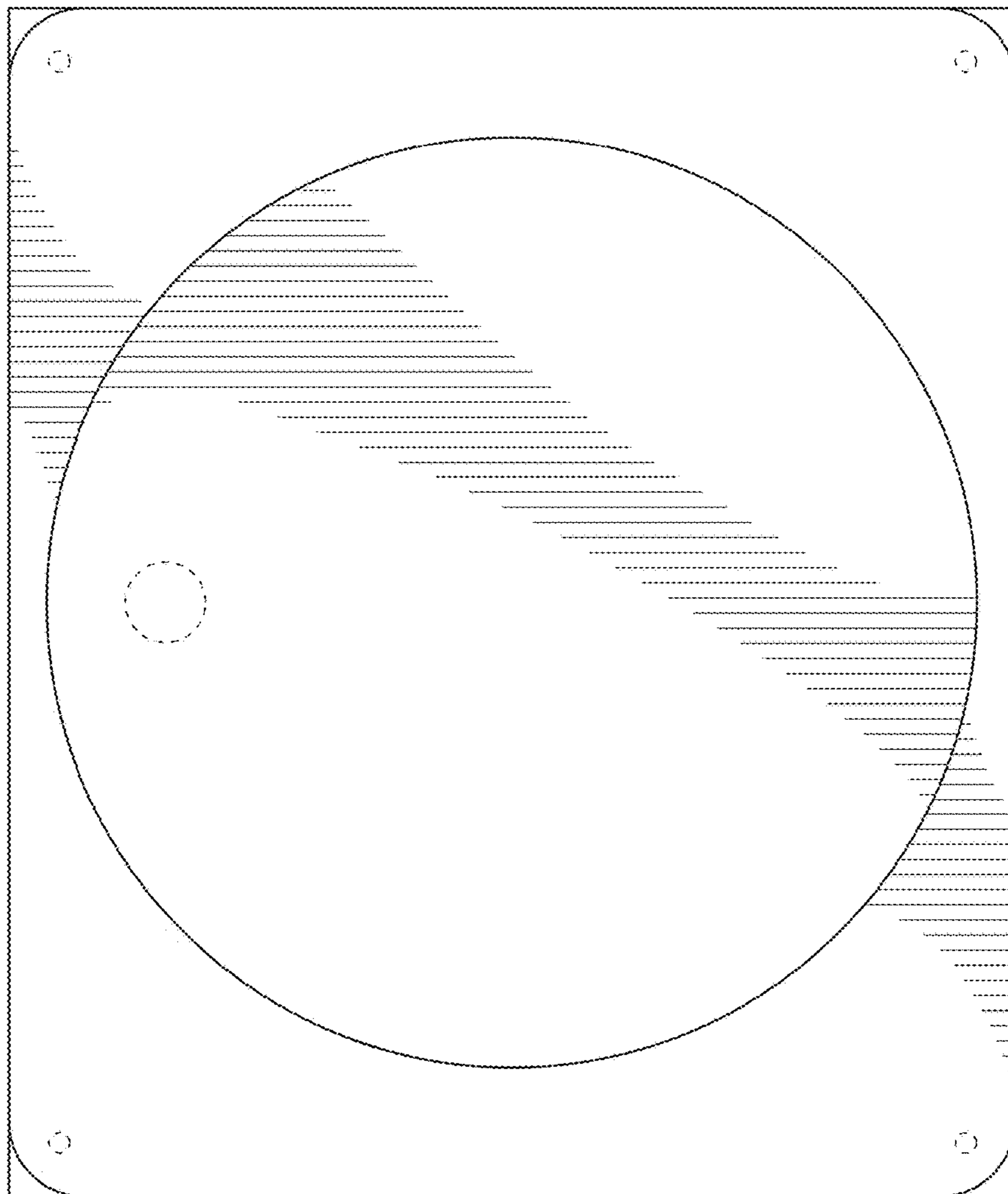

FIG. 3

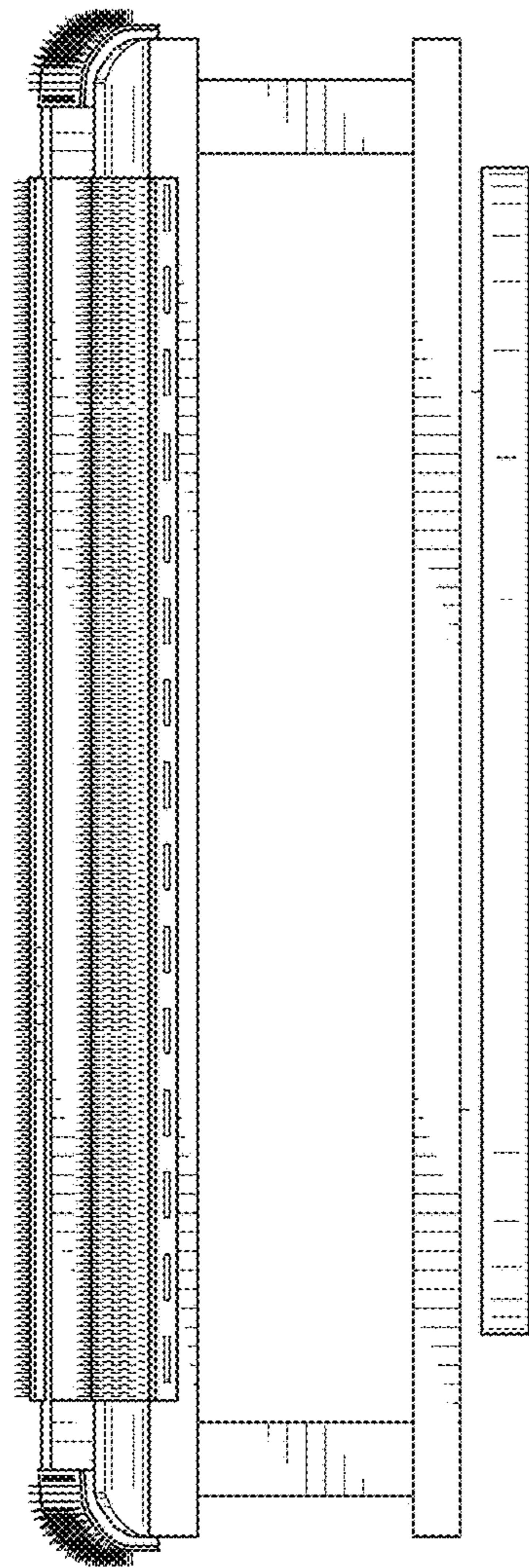

FIG. 4

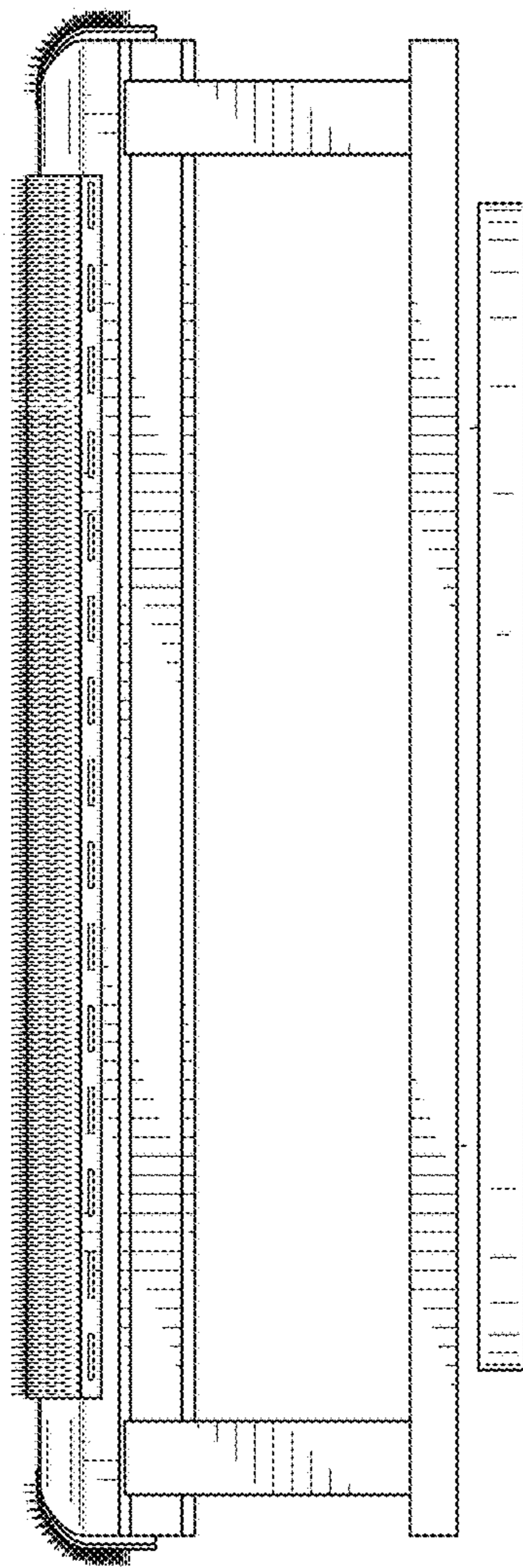

FIG. 5

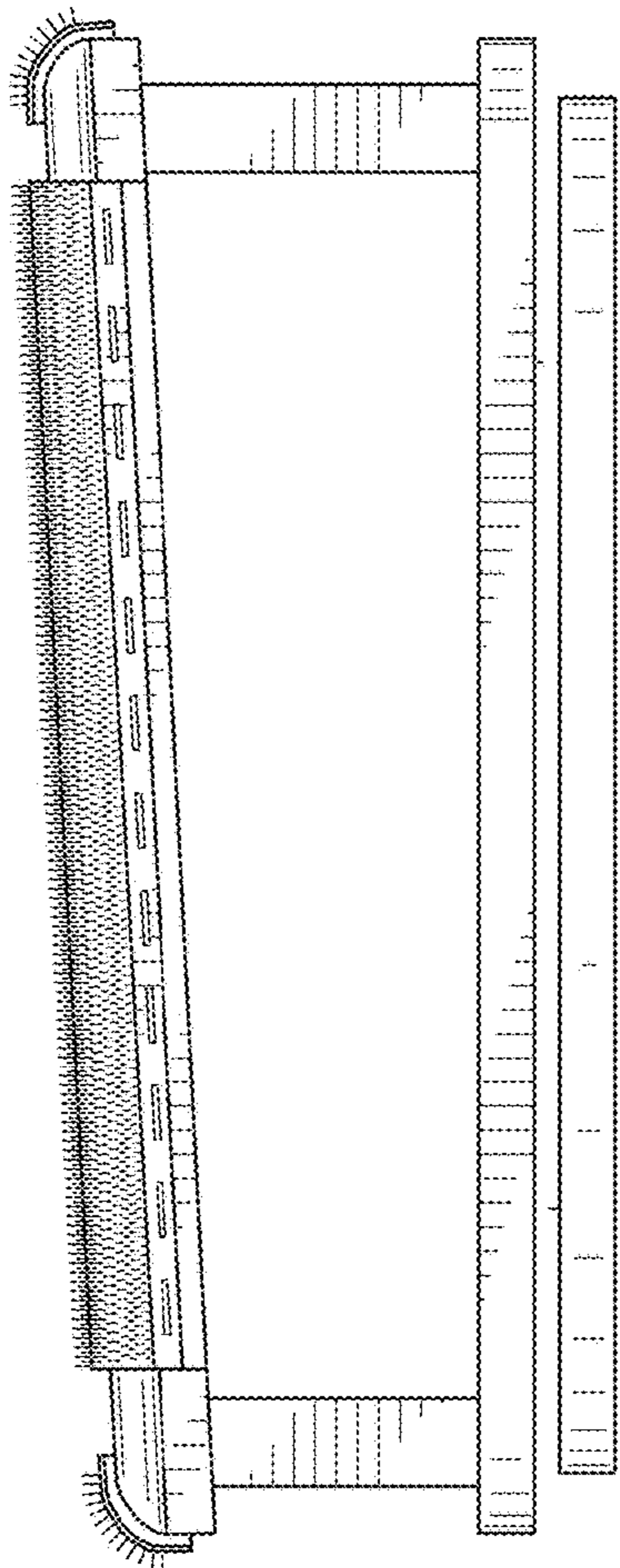

FIG. 6

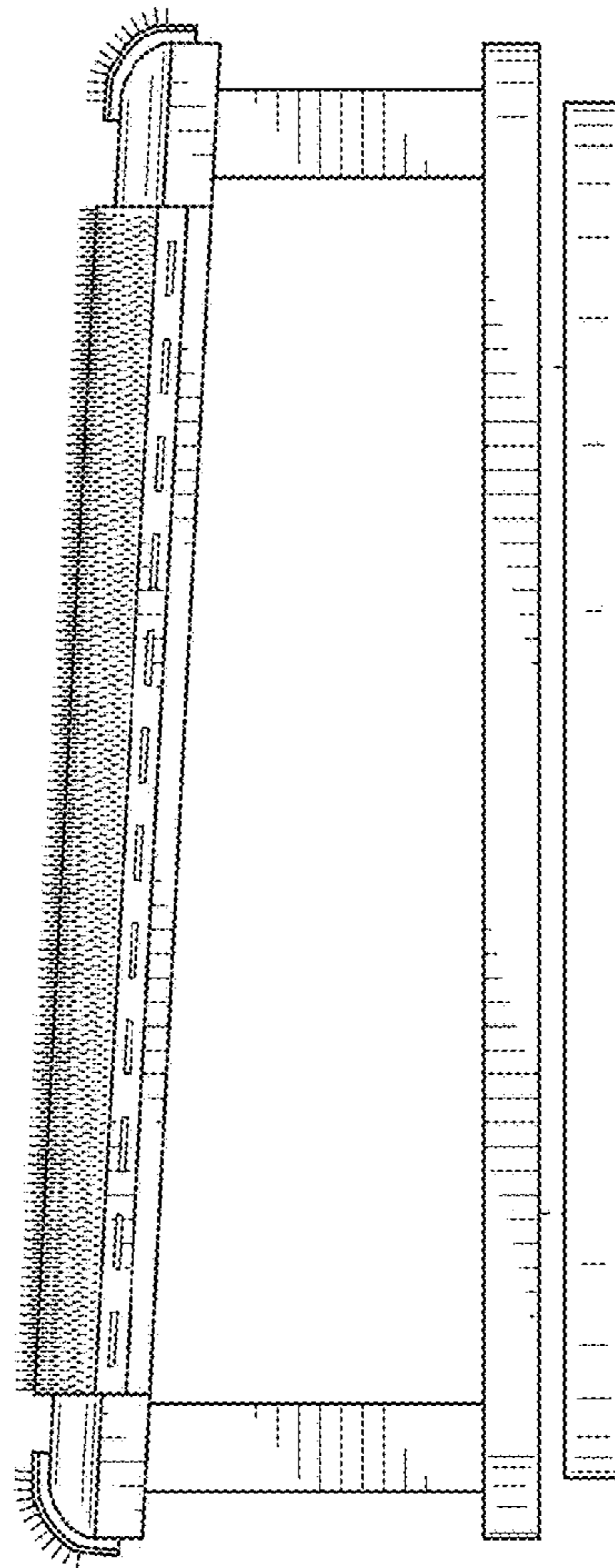

FIG. 7

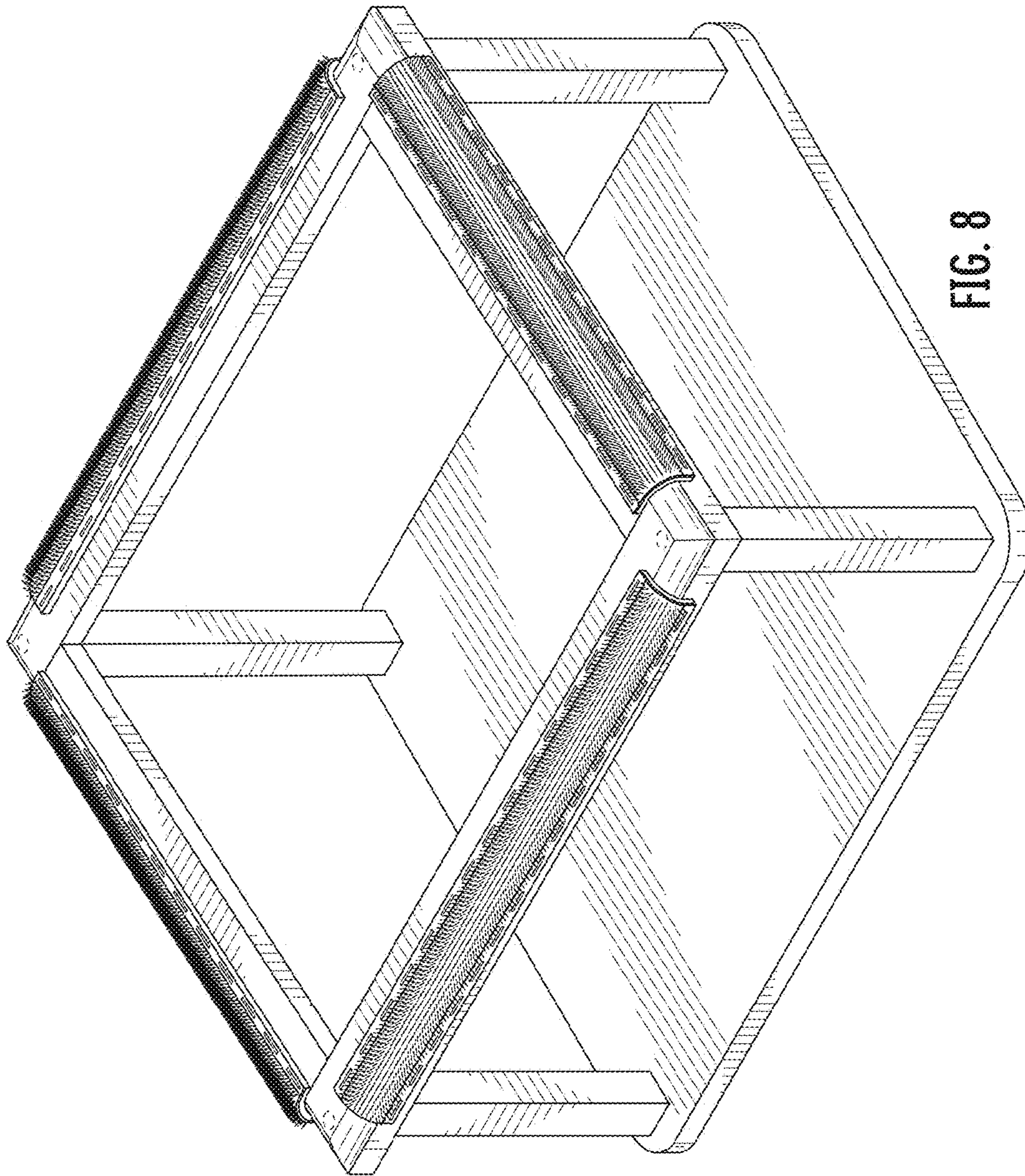

FIG. 8

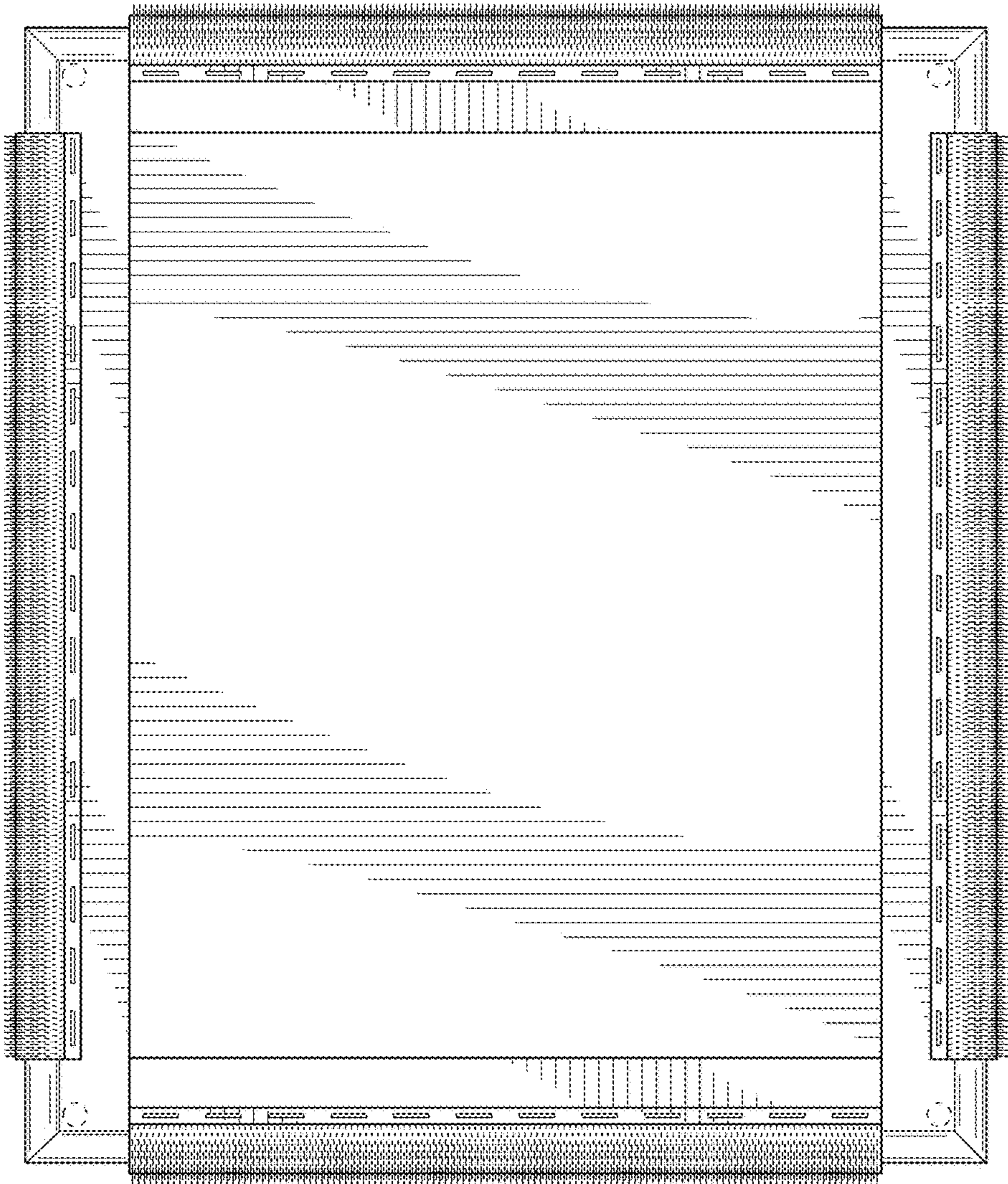

FIG. 9

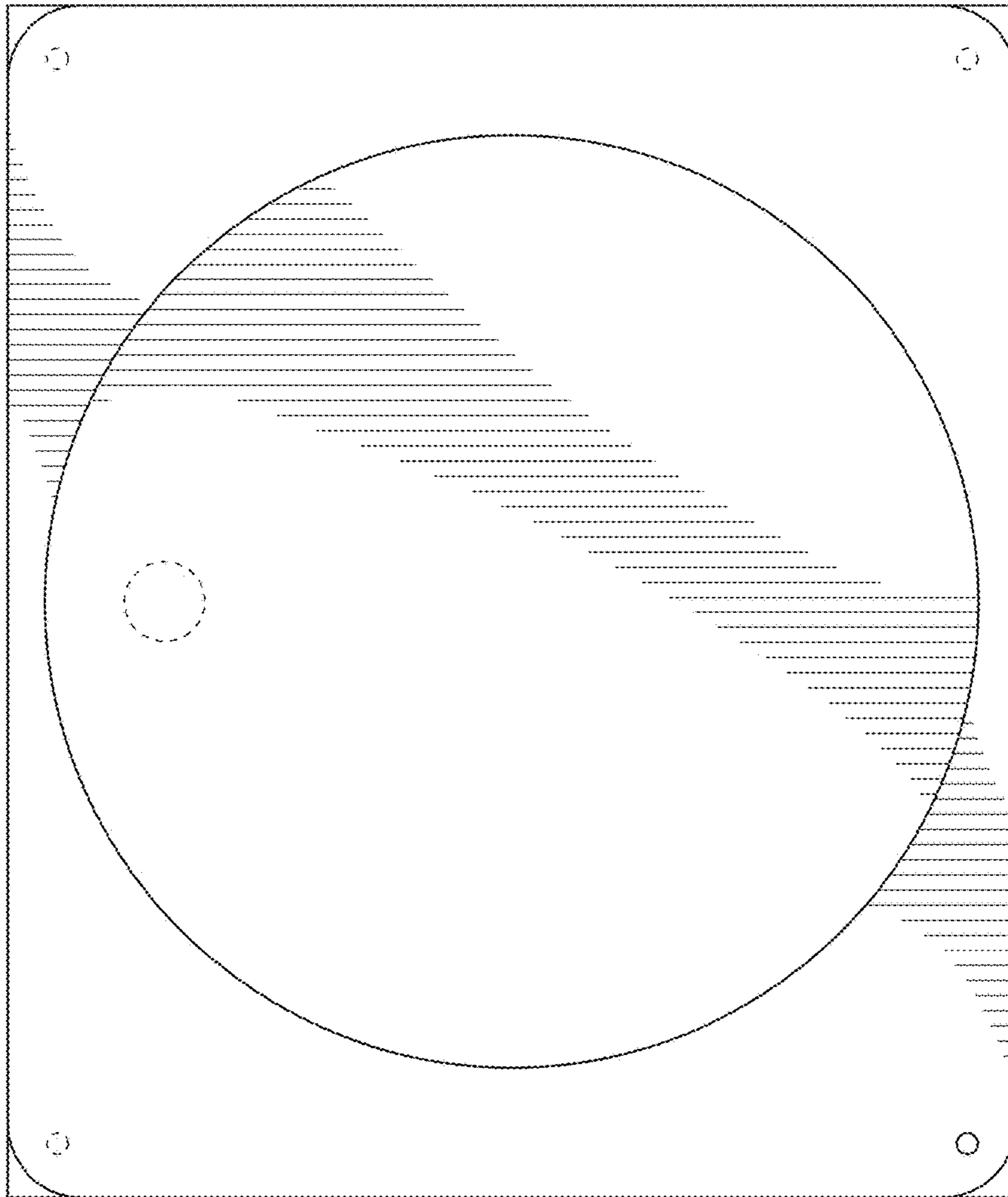

FIG. 10

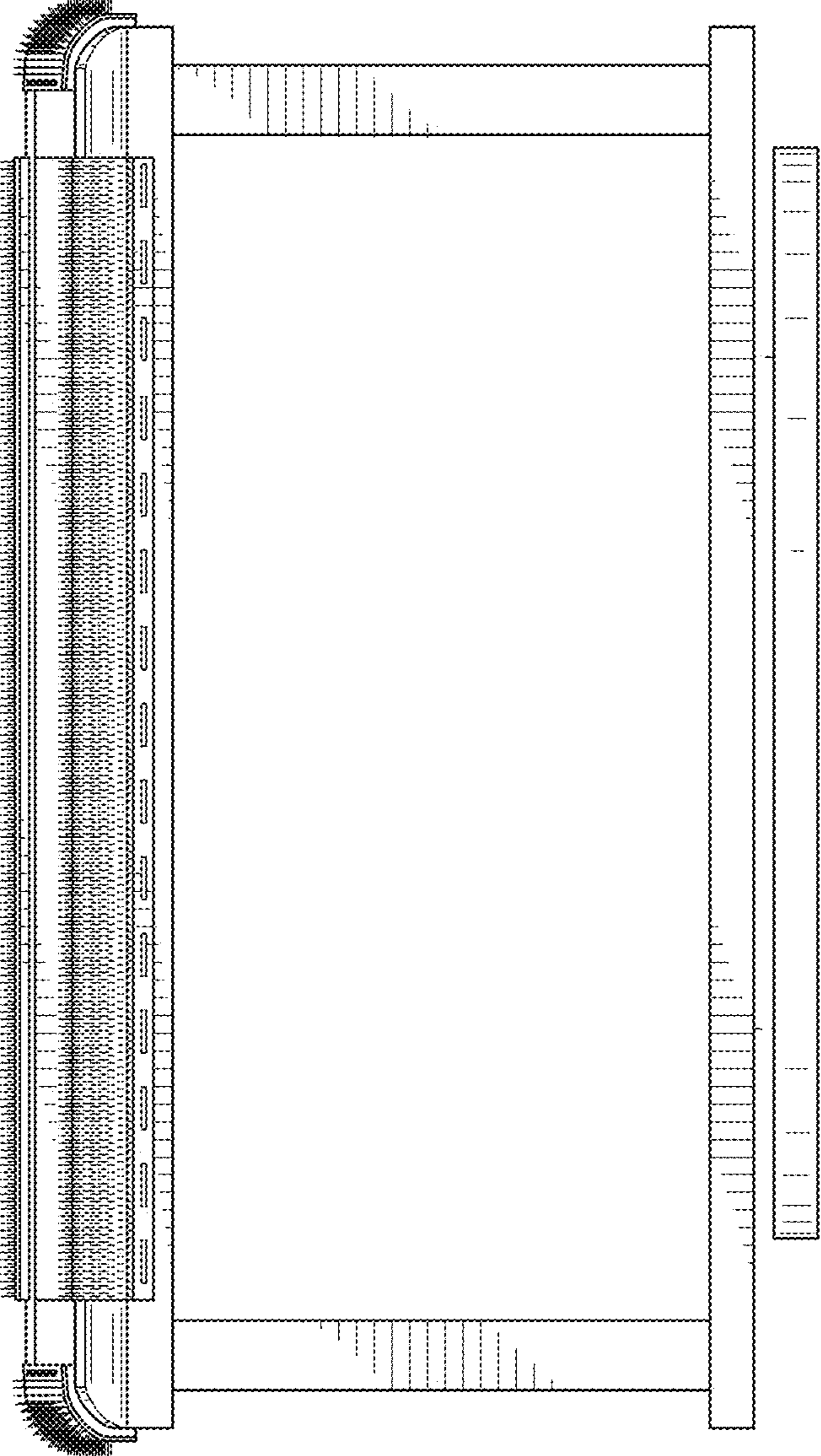

FIG. 11

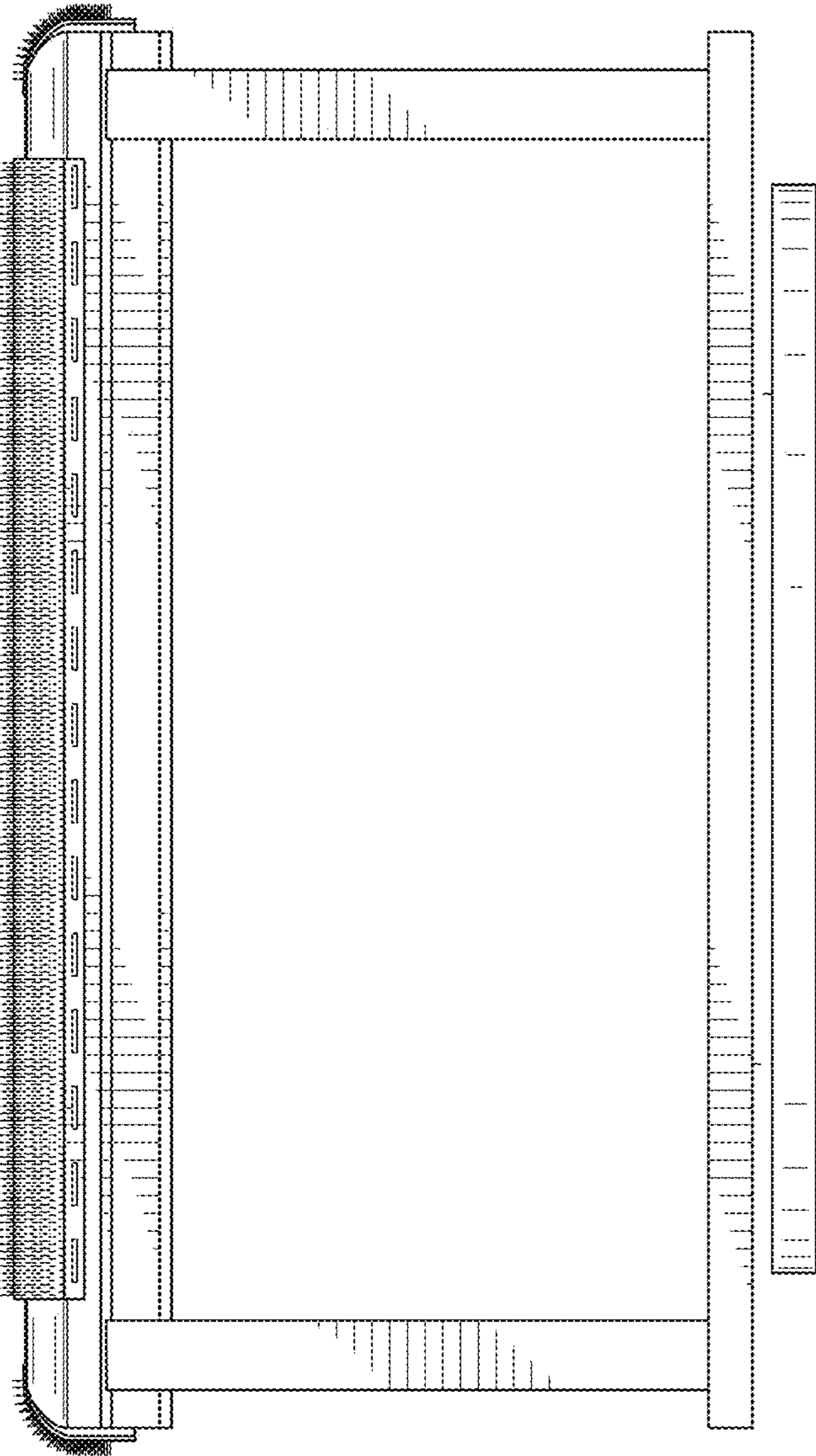

FIG. 12

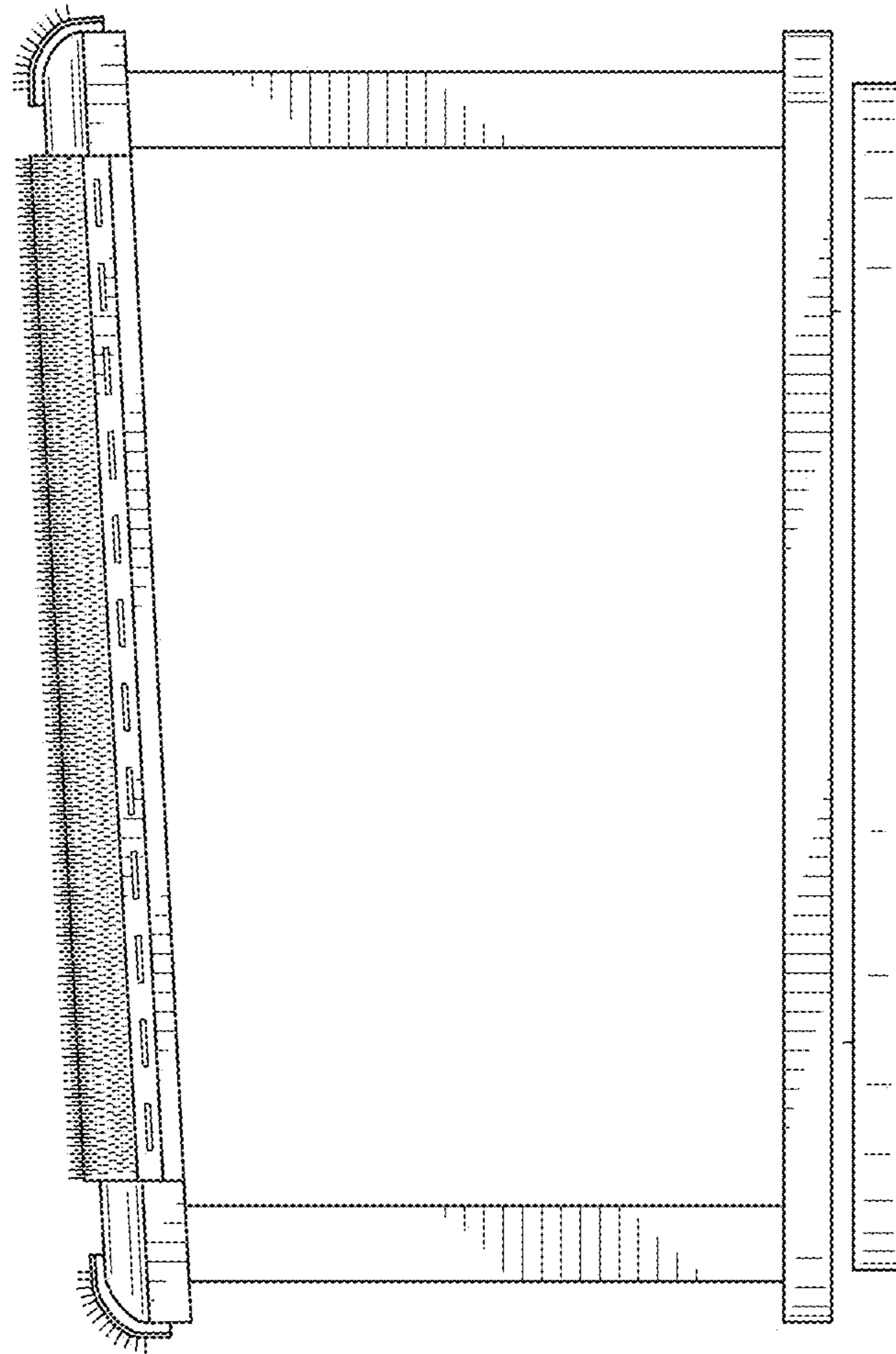

FIG. 13

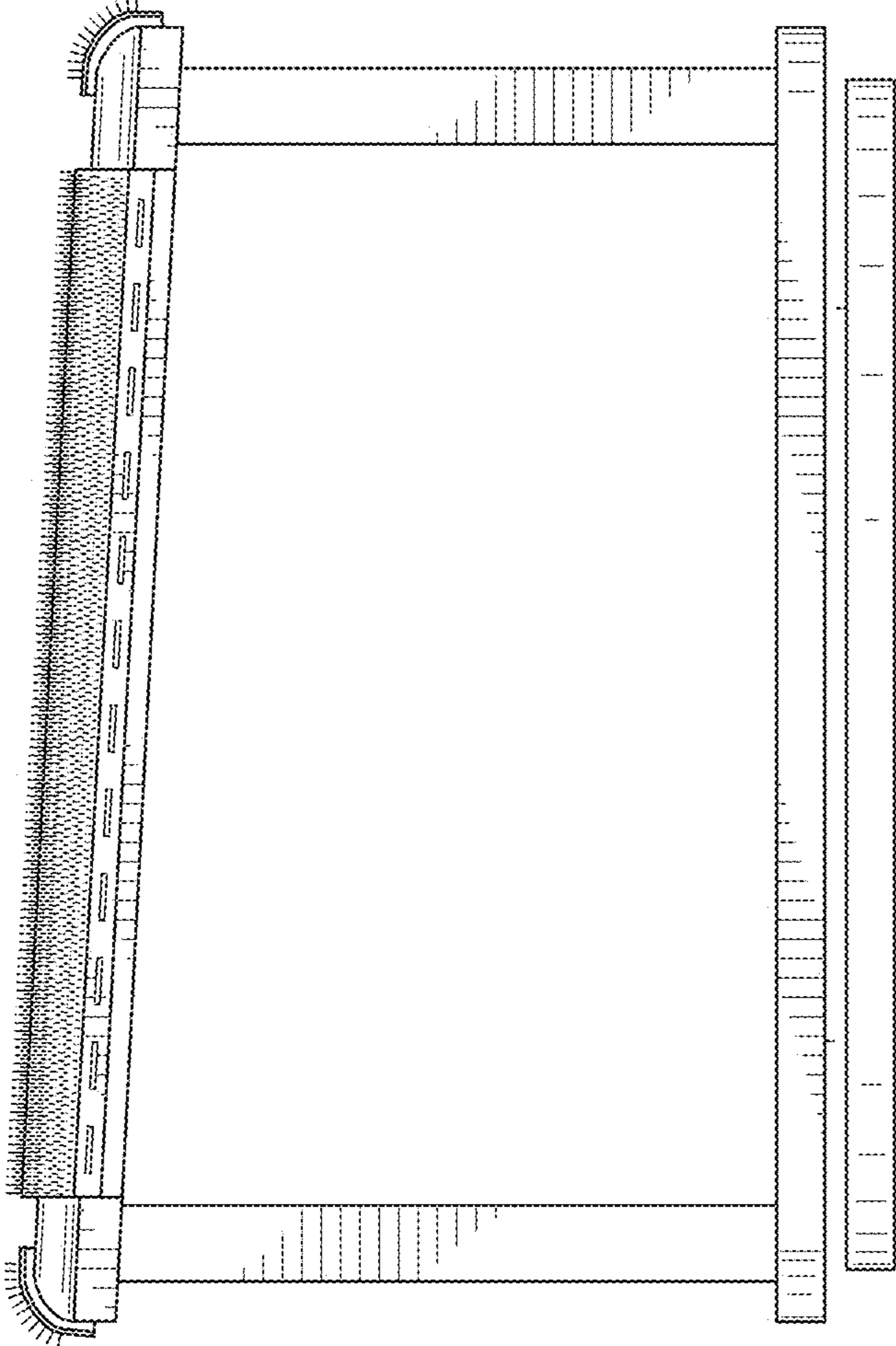

FIG. 14