

US00D860589S

(12) **United States Design Patent** (10) **Patent No.:** **US D860,589 S**
Goedde (45) **Date of Patent:** **** Sep. 24, 2019**

(54) **COSTUME**

(74) *Attorney, Agent, or Firm* — Levine Bagade Han LLP

(71) Applicant: **Suitables, Inc.**, Menlo Park, CA (US)

(57) **CLAIM**

(72) Inventor: **Michael A. Goedde**, Menlo Park, CA (US)

The ornamental design for a costume, as shown and described.

(73) Assignee: **Suitables, Inc.**, Menlo Park, CA (US)

DESCRIPTION

(**) Term: **15 Years**

(21) Appl. No.: **29/669,071**

(22) Filed: **Nov. 5, 2018**

Related U.S. Application Data

(63) Continuation of application No. 29/608,923, filed on Jun. 27, 2017, now Pat. No. Des. 833,112.

(51) **LOC (12) Cl.** **02-02**

(52) **U.S. Cl.**
USPC **D2/741**

(58) **Field of Classification Search**
USPC D2/741

(Continued)

(56) **References Cited**

U.S. PATENT DOCUMENTS

535,908 A 3/1895 Kierolf
758,892 A 5/1904 Bewsic

(Continued)

OTHER PUBLICATIONS

Cardboard Aeroplane Costume, posted at en.smallable.com, posting date not given, [online], [site visited Sep. 10, 2018]. Available from Internet, URL: <https://en.smallable.com/cardboard-aeroplane-costume-pink-mister-tody-94030.html> (Year: 2018).

(Continued)

Primary Examiner — George D. Kirschbaum

Assistant Examiner — Maria J Edwards

1 Claim, 13 Drawing Sheets

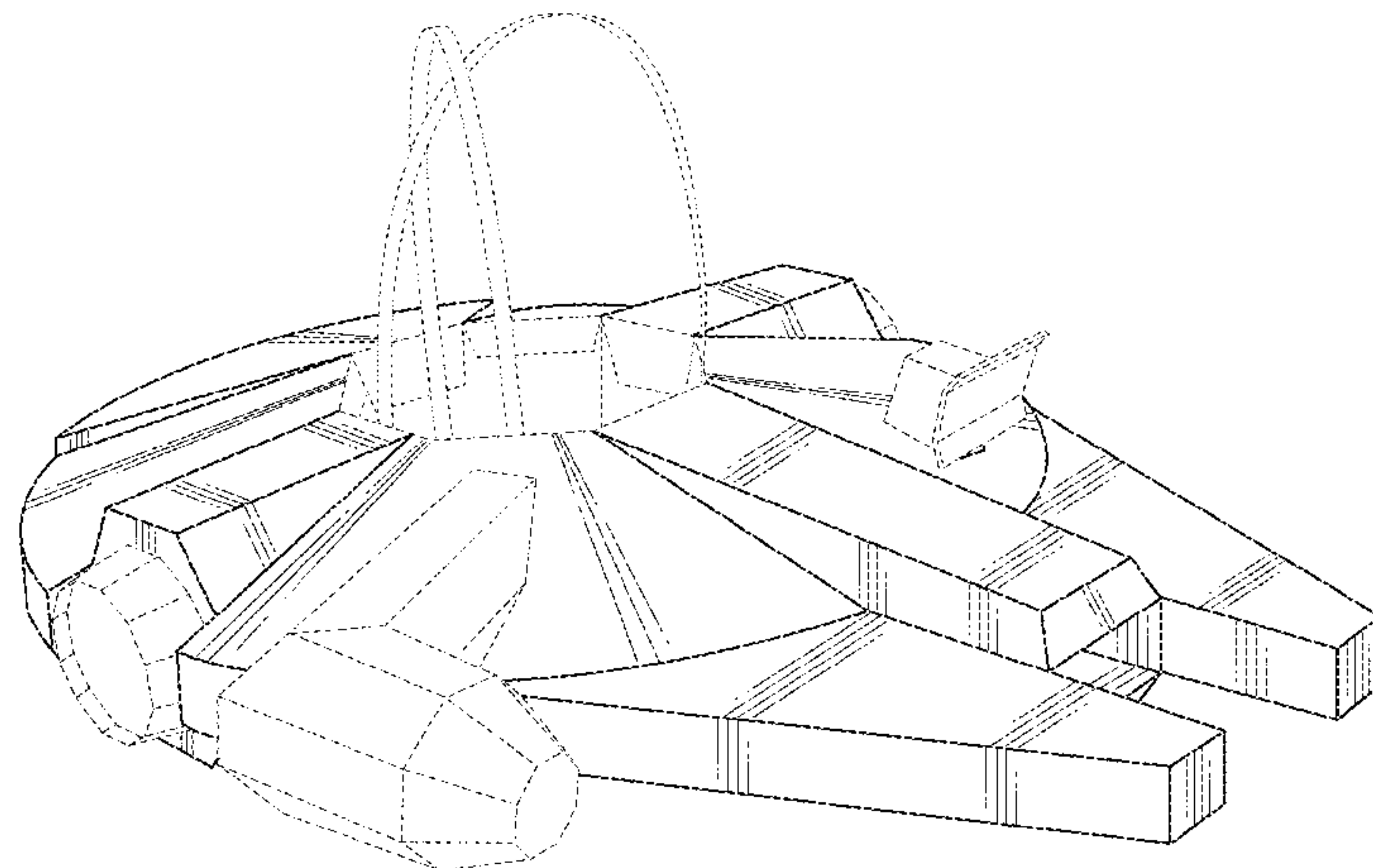

(58) **Field of Classification Search**
 CPC .. A41D 13/1209; A41D 1/22; A41D 13/0015;
 A41D 13/018; A41D 13/0543; A41D
 13/0575; A41D 1/00; A41D 1/04; A41D
 29/00; A41D 11/00; A41D 27/08; A41D
 27/085; A41D 15/04; A41D 2400/42;
 A41D 13/04; A41D 1/002; A41D
 2300/324; A41D 2400/26; A41D 27/20;
 A41D 27/28; A41D 31/00; A41D 3/08;
 A63J 7/005

See application file for complete search history.

(56) **References Cited**

U.S. PATENT DOCUMENTS

984,735	A	2/1911	Bailey
D189,484	S	12/1960	Ramniceanu
3,042,399	A	7/1962	Lewendowski
3,099,443	A	7/1963	Koch
D254,816	S	4/1980	Sloan
D256,736	S	9/1980	Bajork
D258,158	S	2/1981	Bunke
D266,263	S	9/1982	Zachar
D267,025	S	11/1982	Lucas, Jr. et al.
D270,009	S	8/1983	Short et al.
D272,839	S	2/1984	Jennings et al.
D288,945	S	3/1987	Rodis-Jamero et al.
D300,322	S	3/1989	Lam
D307,923	S	5/1990	Probert
5,022,681	A	6/1991	Penick
D328,618	S	8/1992	Wiley
5,162,010	A	11/1992	Krebs
D335,902	S	5/1993	Tsai
5,320,065	A	6/1994	Leopold
D362,470	S	9/1995	Smith

5,562,520	A	10/1996	Pridonoff et al.
D380,346	S	7/1997	Chiang
D421,777	S	3/2000	Wei
D422,322	S	4/2000	Wei
D422,650	S	4/2000	Wei
D429,502	S	8/2000	Christianson
D537,876	S	3/2007	Balzer
7,552,563	B2	6/2009	Becker
D637,707	S	5/2011	Nordwall
8,234,835	B2	8/2012	Dye et al.
8,286,266	B2	10/2012	Berman
9,072,980	B2	7/2015	van Tilburg
D833,112	S *	11/2018	Goedde D2/741
D836,885	S *	1/2019	Goedde D2/741
2011/0016601	A1	1/2011	Berman
2011/0281495	A1	11/2011	Welsh et al.
2011/0281496	A1	11/2011	Welsh et al.
2012/0015582	A1	1/2012	van Tilburg
2015/0038246	A1	2/2015	Zeid

OTHER PUBLICATIONS

DIY Cardboard Millennium Falcon, posted at allfortheboys.com, posting date not given, [online], [site visited Sep. 10, 2018]. Available from Internet, URL: <https://allfortheboys.com/diy-cardboard-star-wars-vehicles/> (Year: 2018).
 Flat Out Frankie Web Catalogue 20160415 (2014_web).
 Han Solo Cosplay, posted at geeksaresexy.net, posting date Oct. 14, 2014, [online], [site visited Sep. 10, 2018]. Available from Internet, URL: <https://www.geeksaresexy.net/2014/10/14/the-best-han-solo-cosplay-youll-see-today/#mtrPk4r5QD91MVQX.32> (Year: 2014).
 Millennium falcon womens costume, posted at flickr.com, posting date Jul. 13, 2002, [online], [site visited Sep. 10, 2018]. Available from Internet, URL: <https://www.flickr.com/photos/33339636@N06/7566908114/in/photostream> (Year: 2012).

* cited by examiner

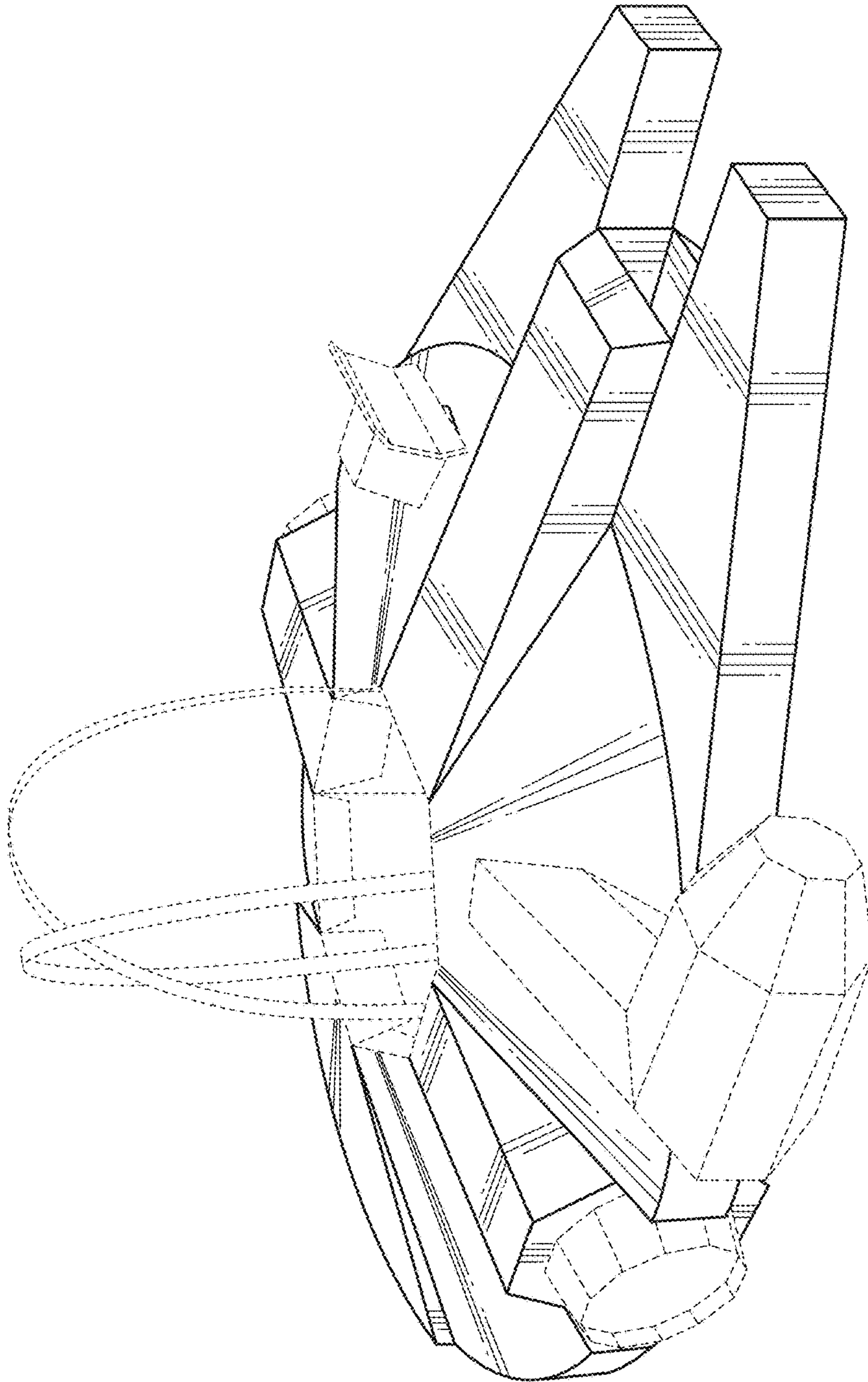

FIG. 1

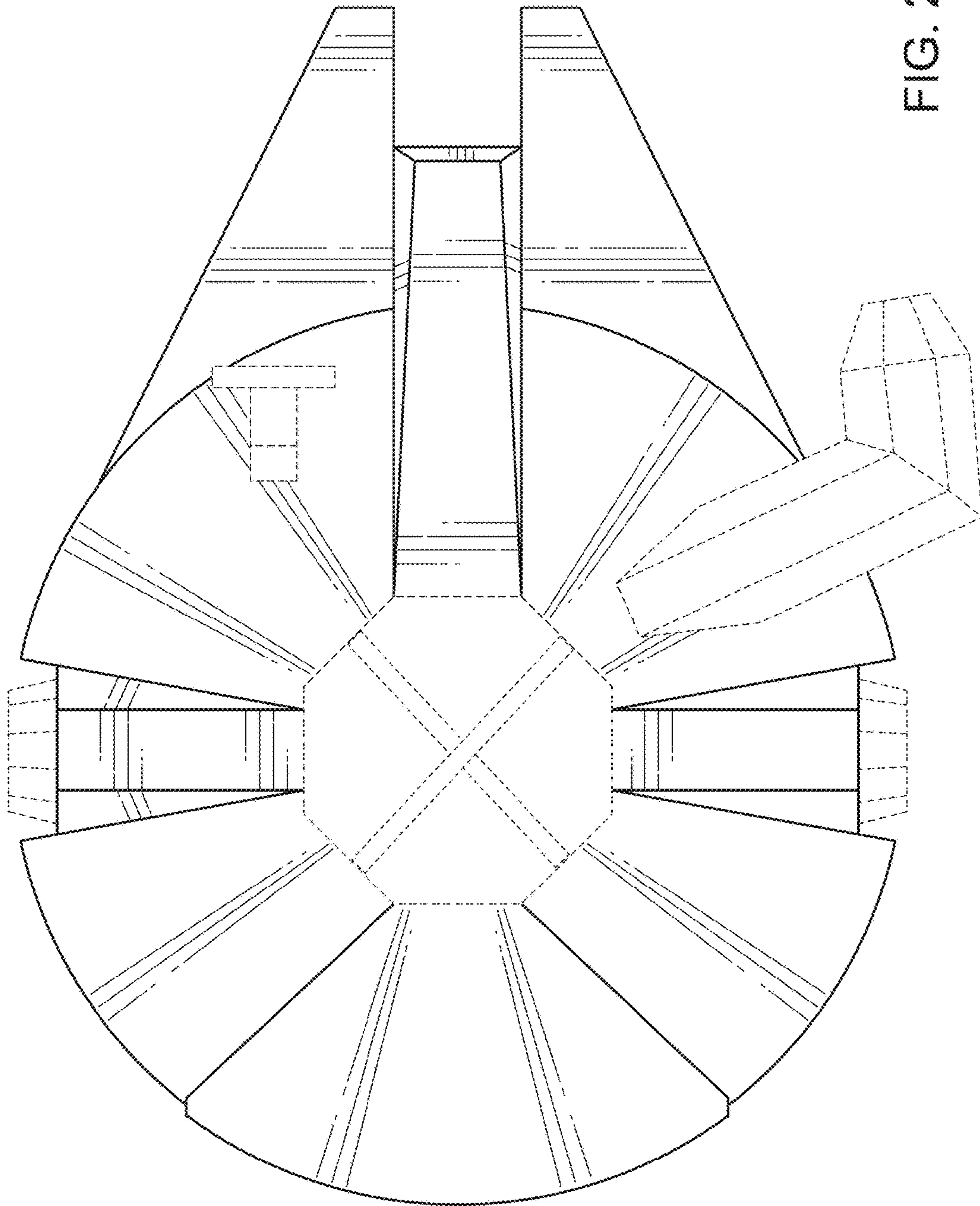

FIG. 2

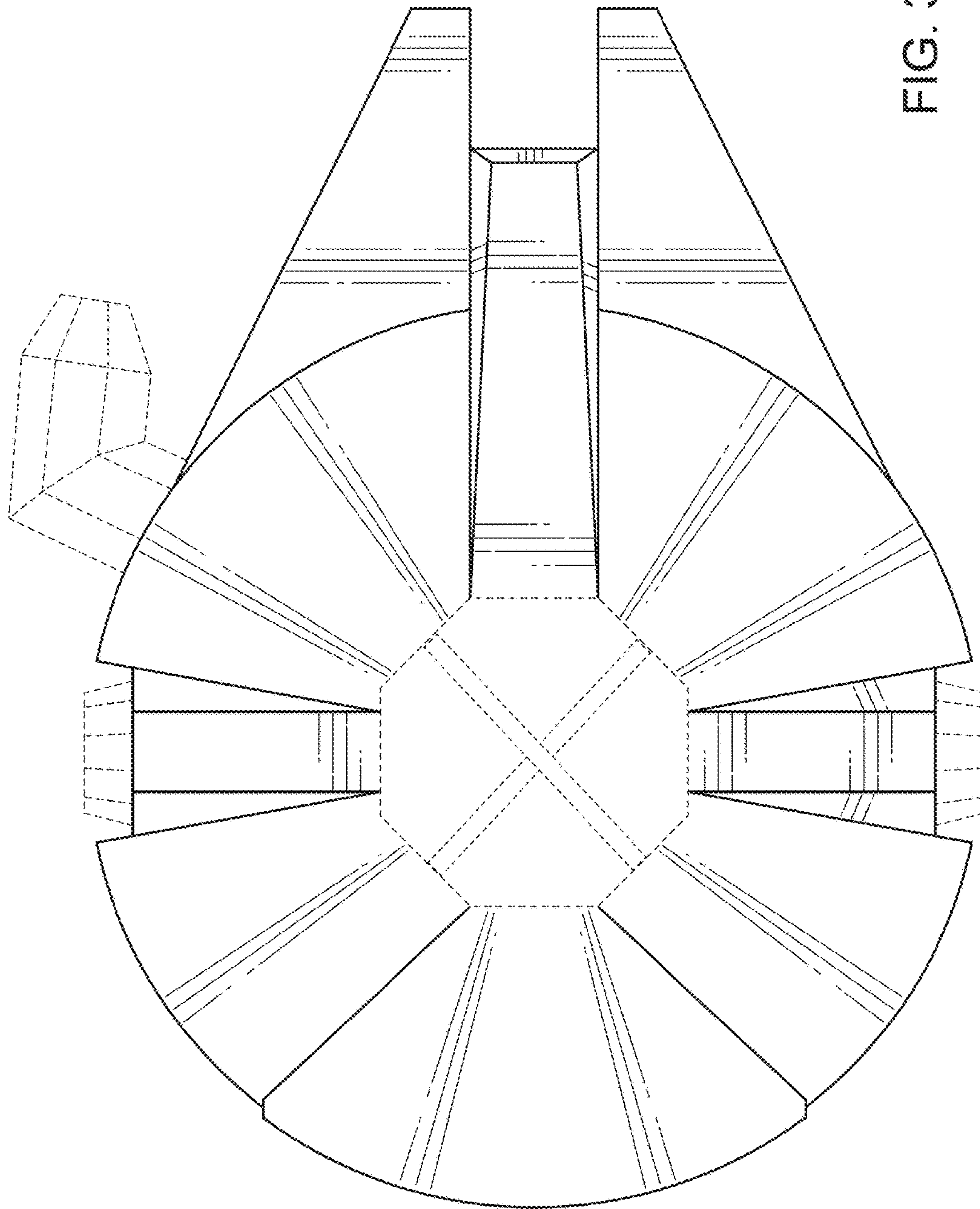

FIG. 3

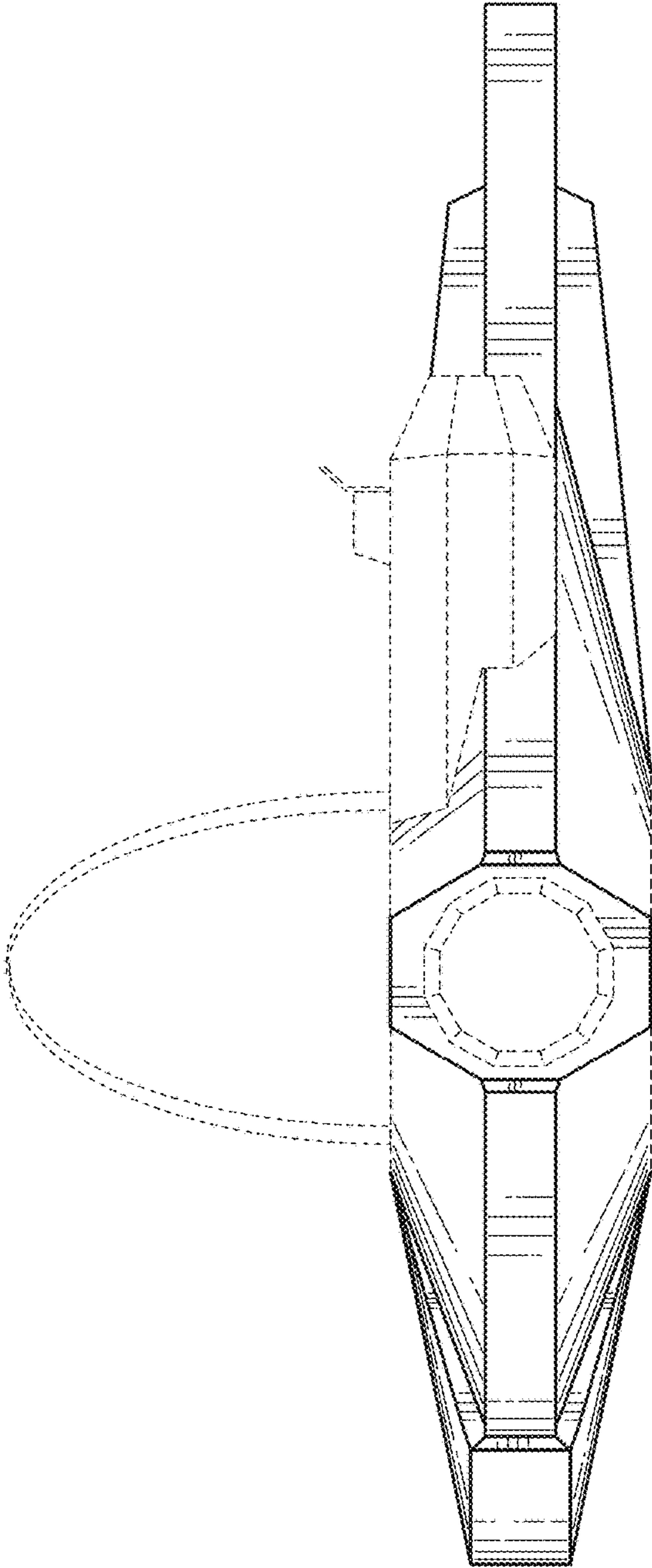

FIG. 4

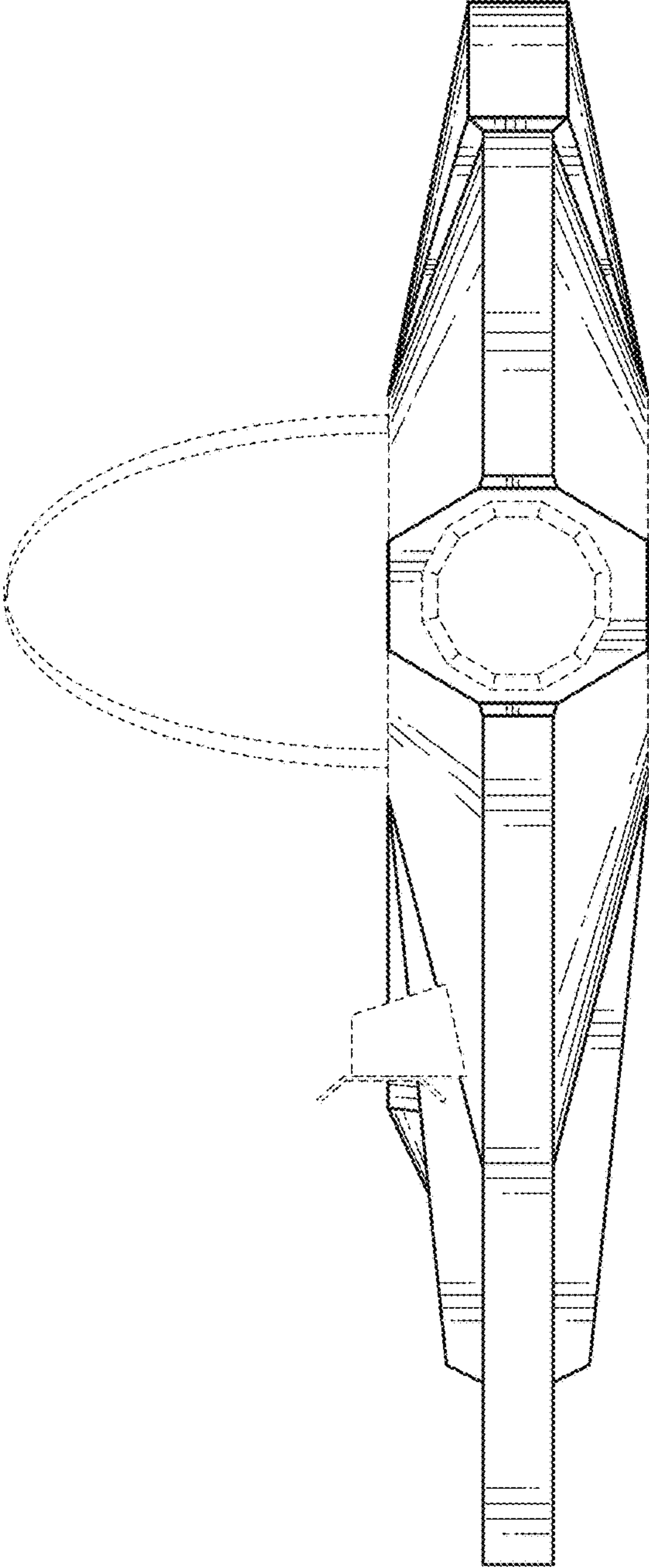

FIG. 5

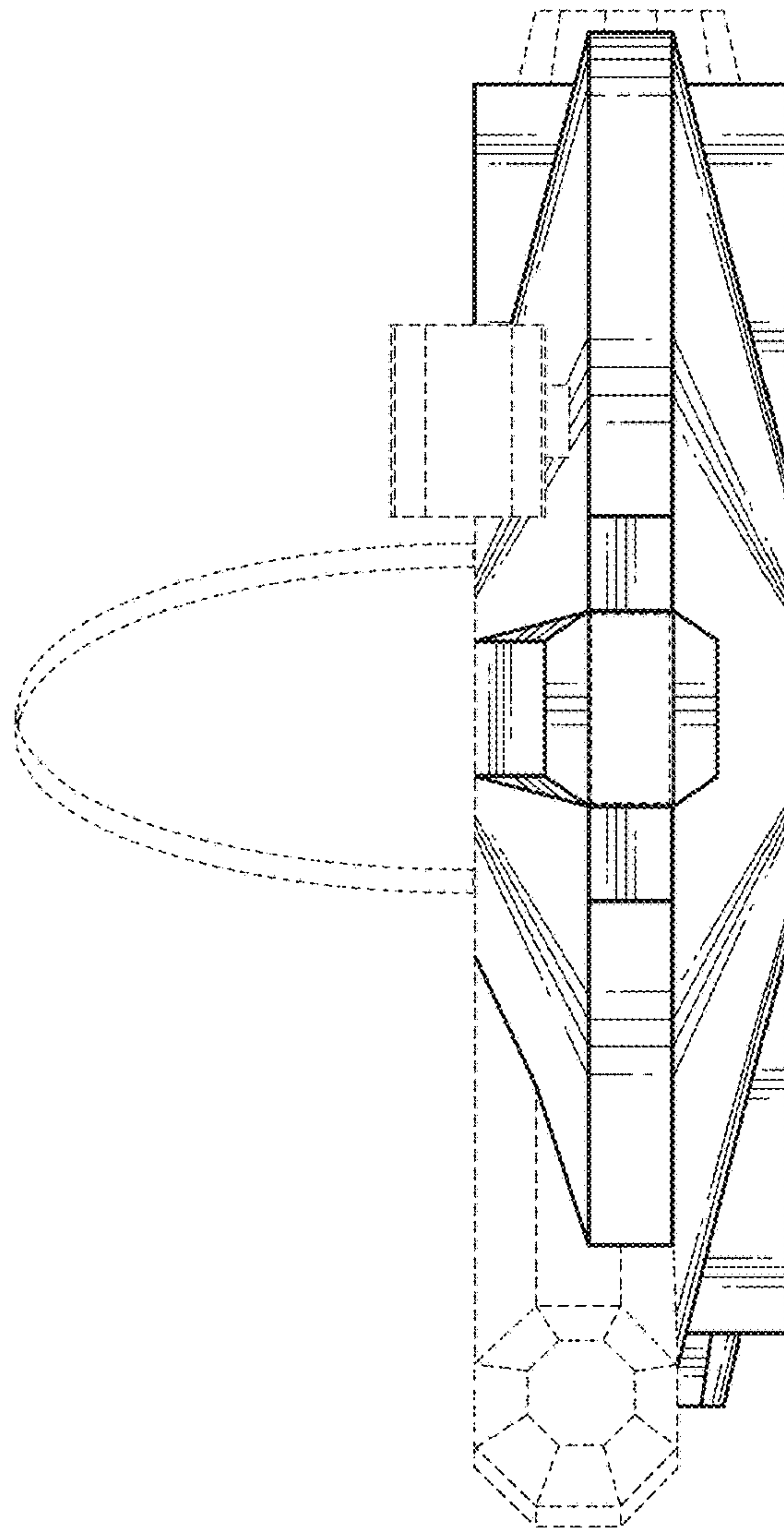

FIG. 6

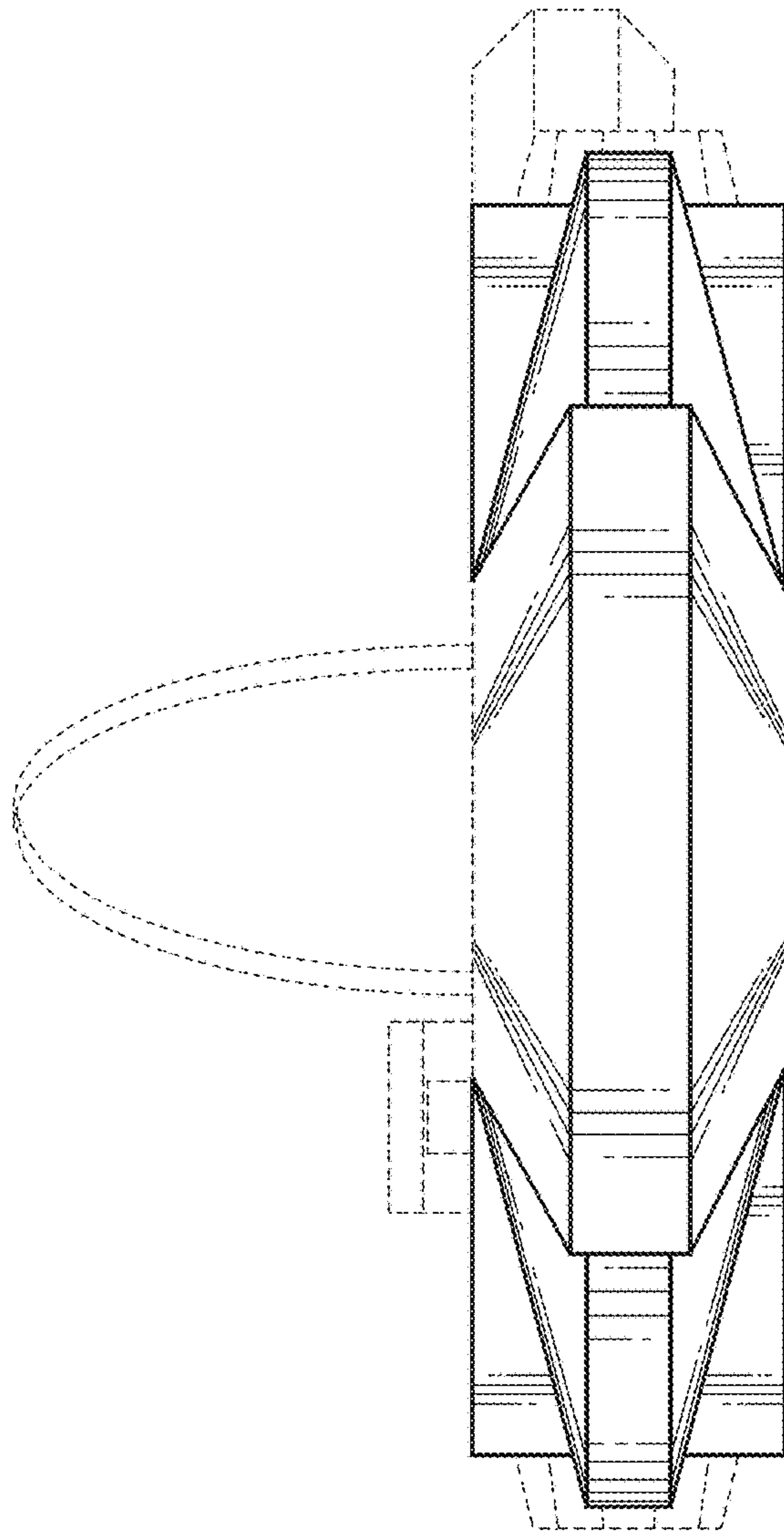

FIG. 7

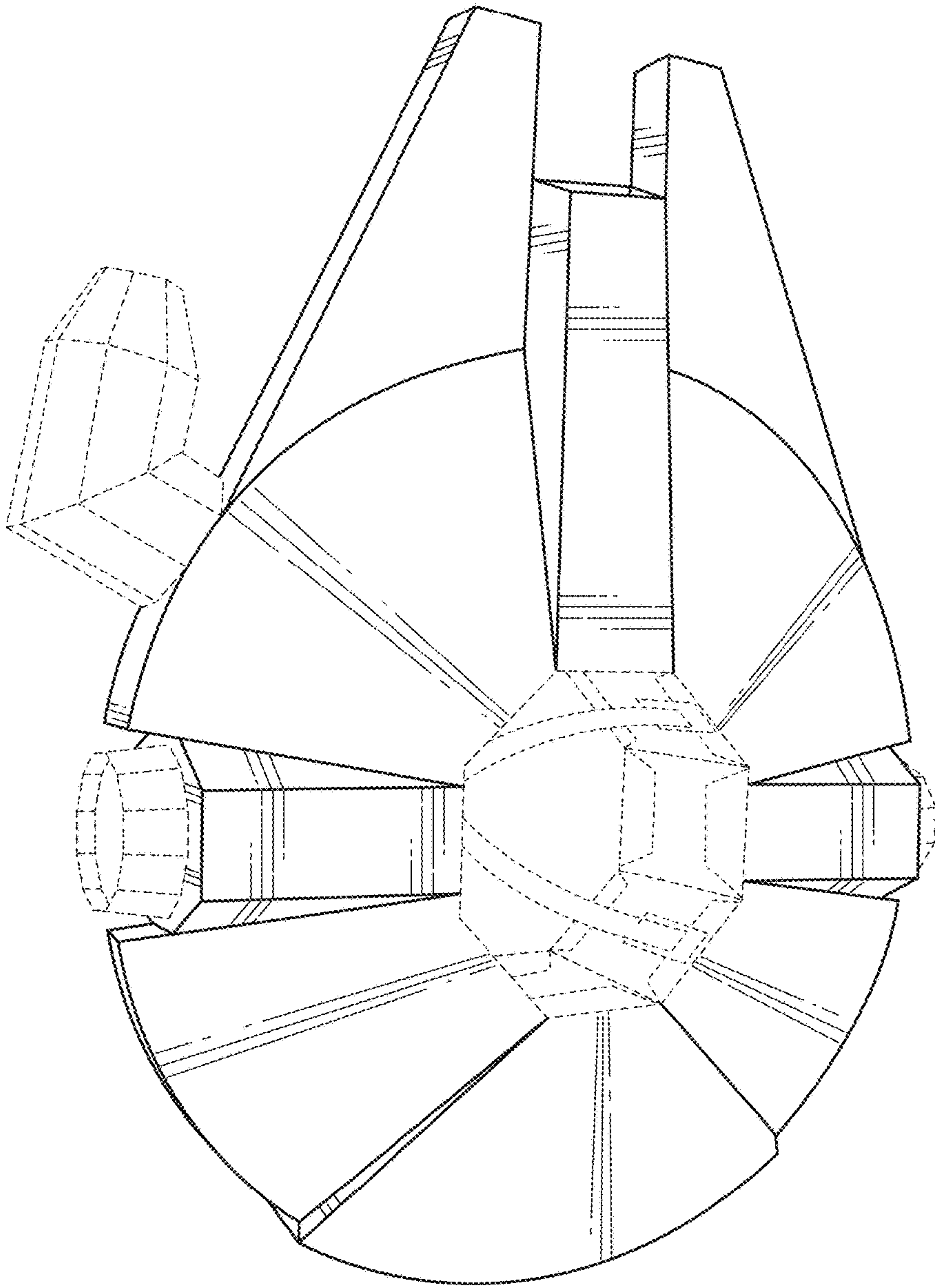

FIG. 8

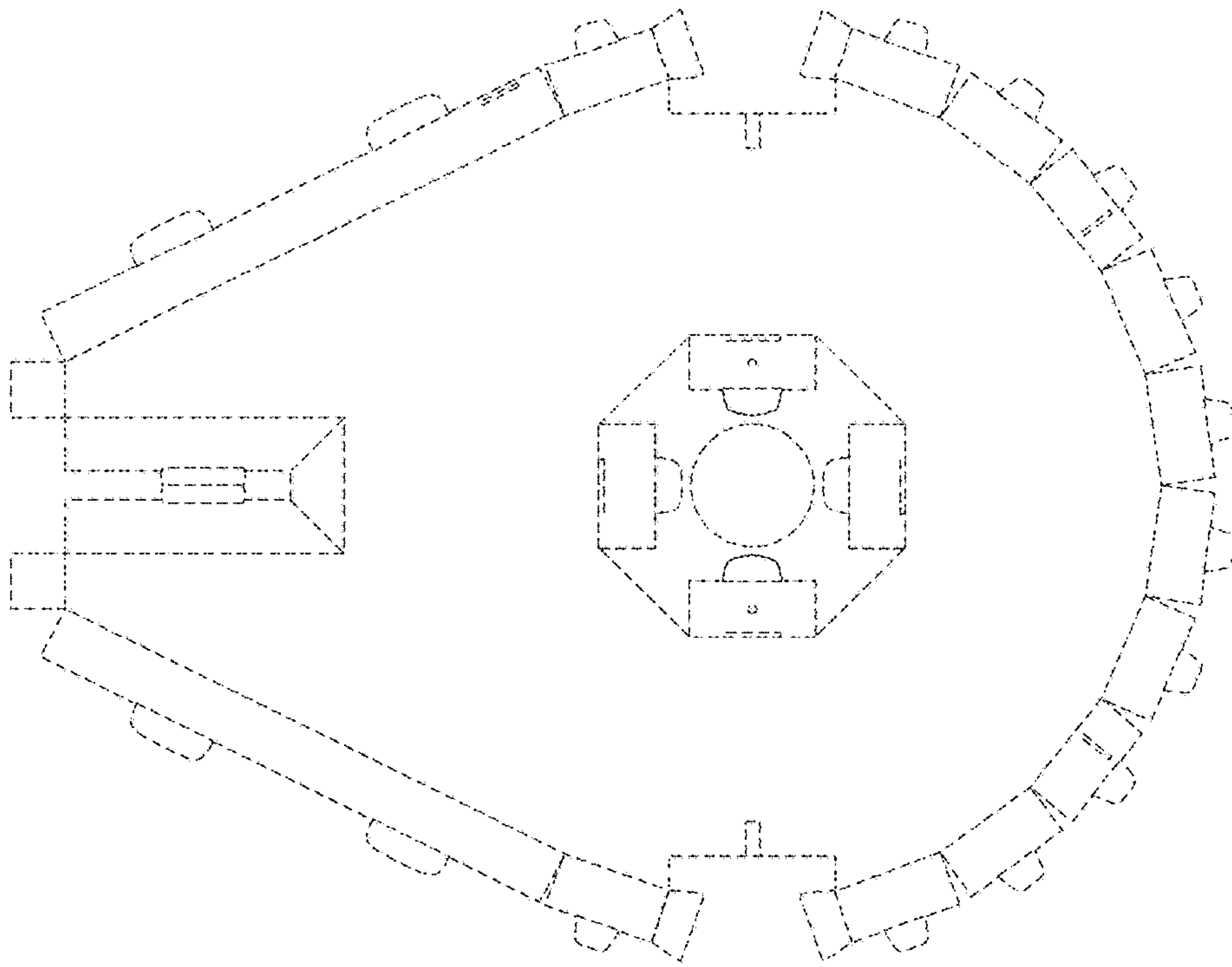

FIG. 10

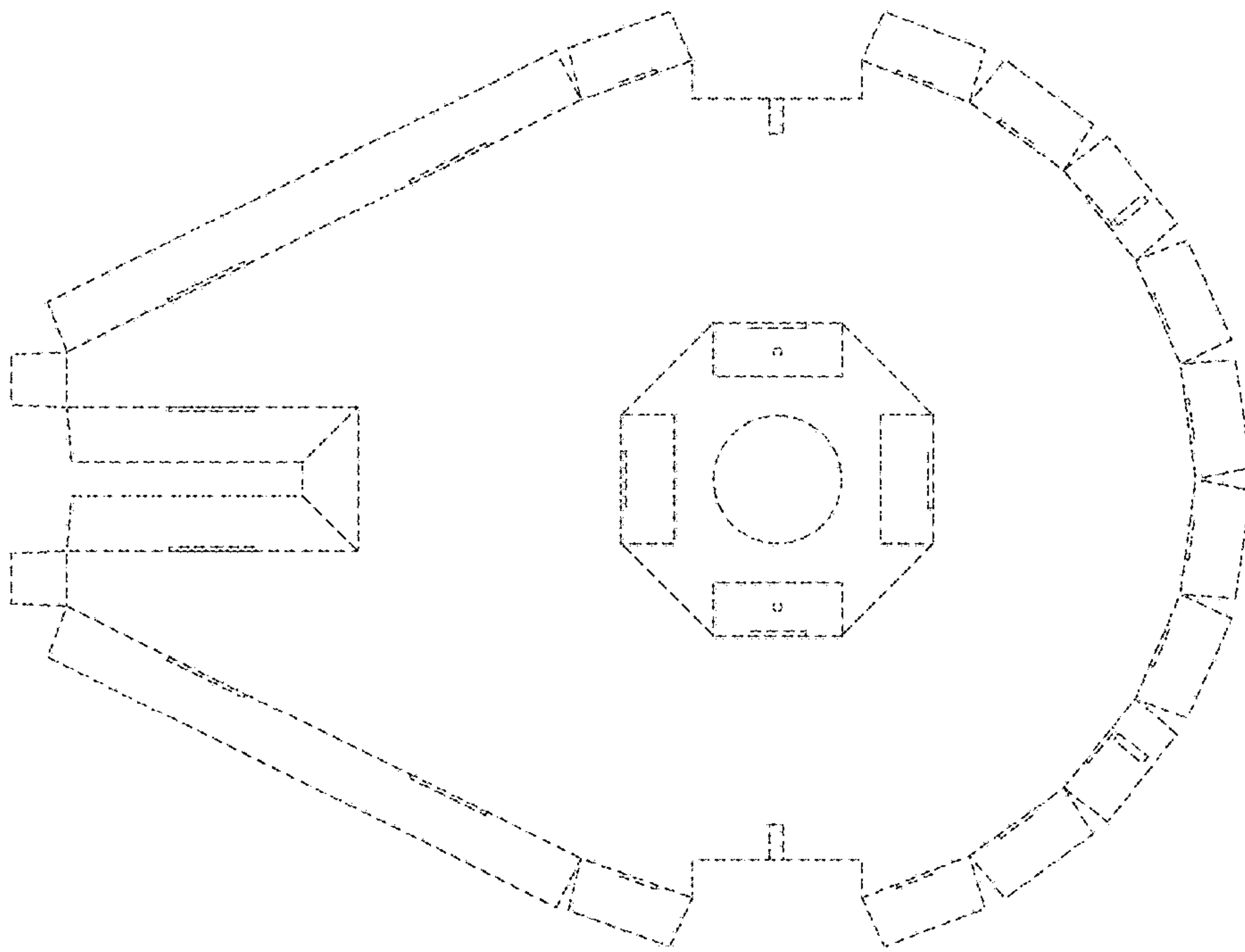

FIG. 9

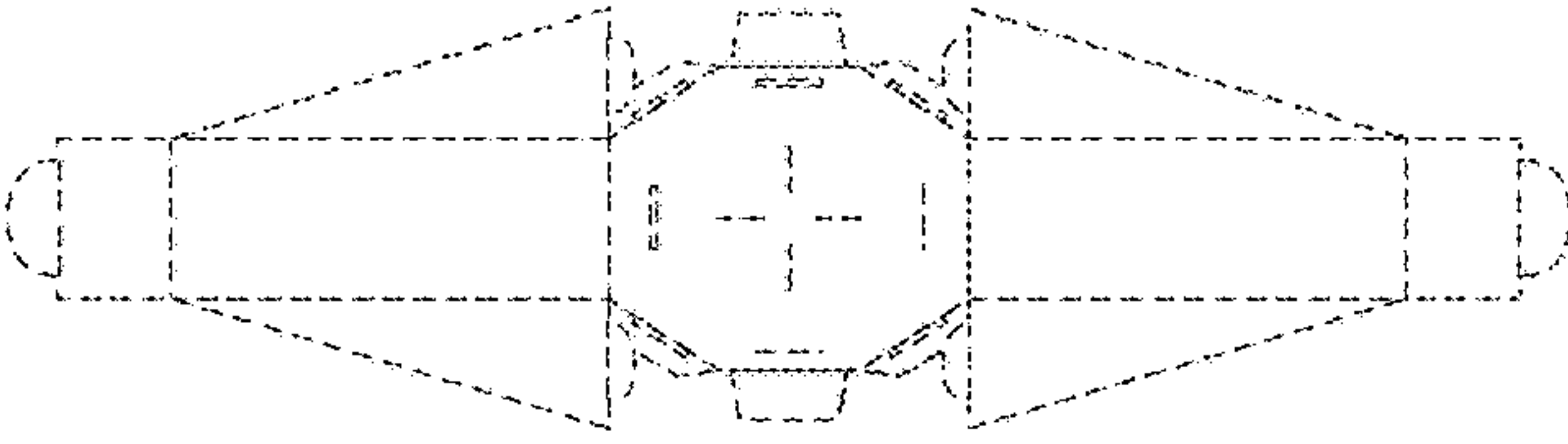

FIG. 11

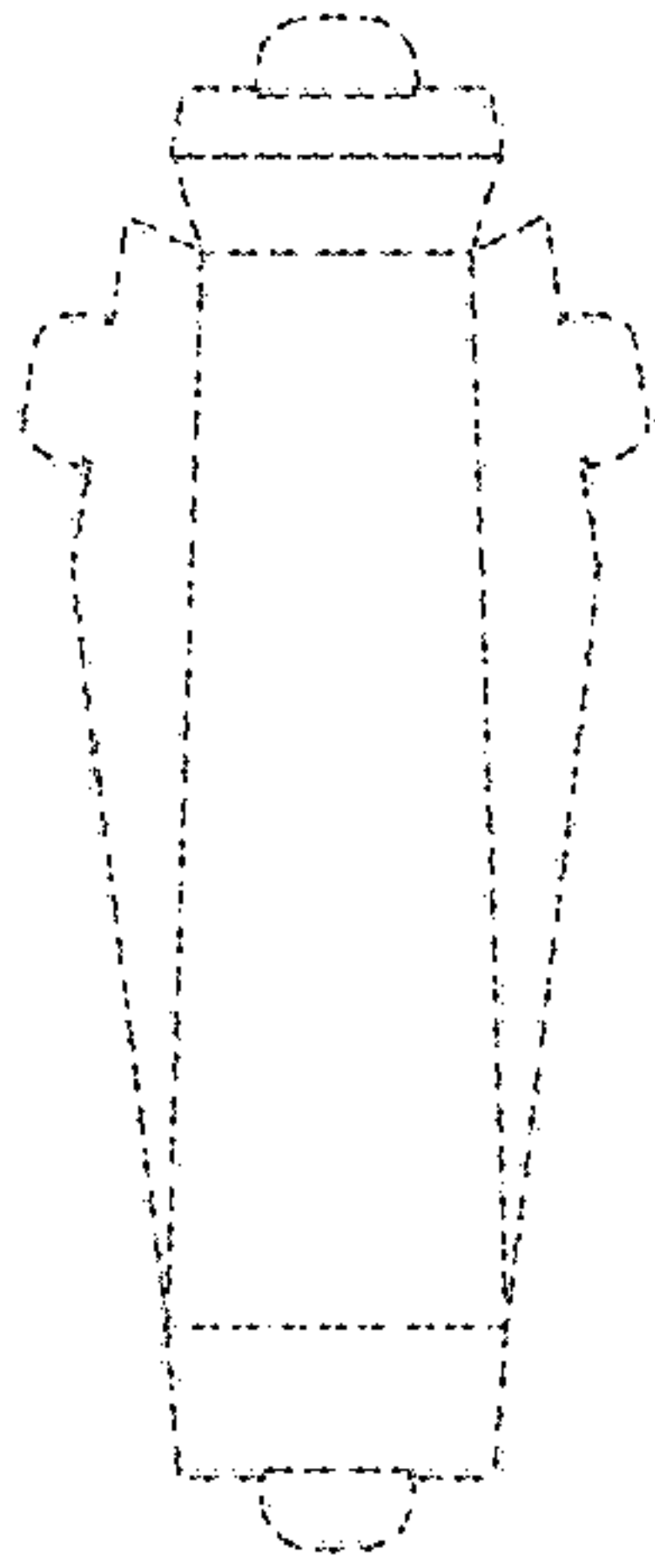

FIG. 12

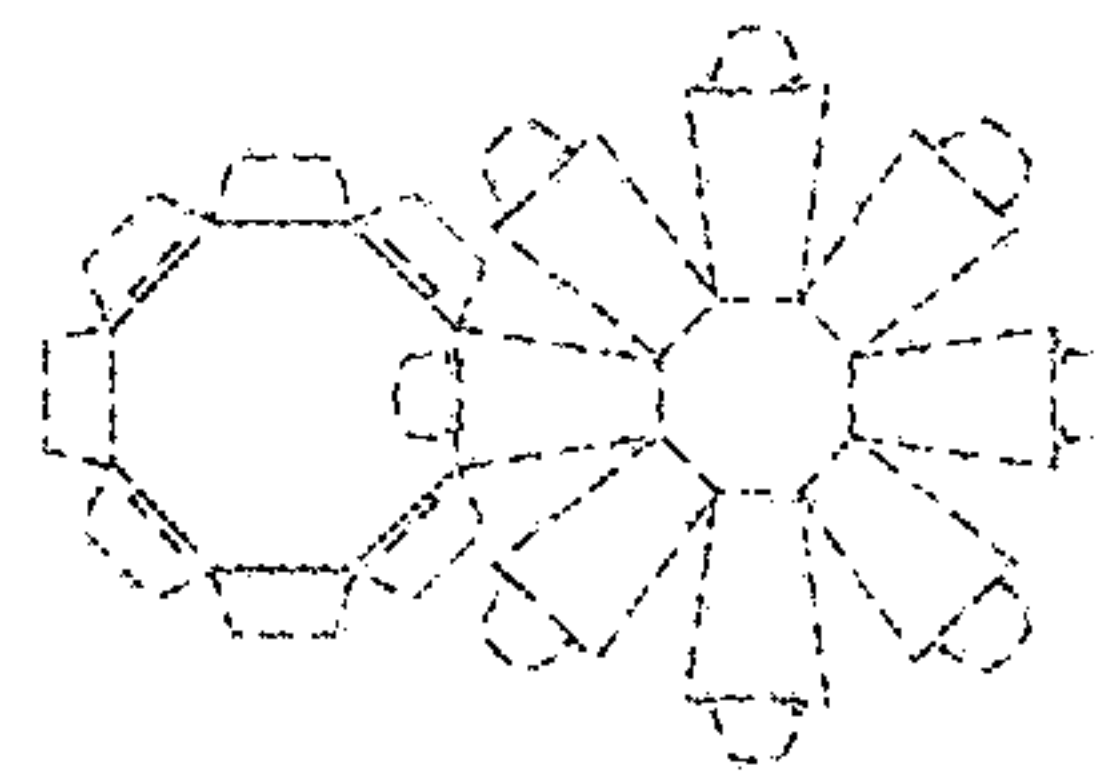

FIG. 13

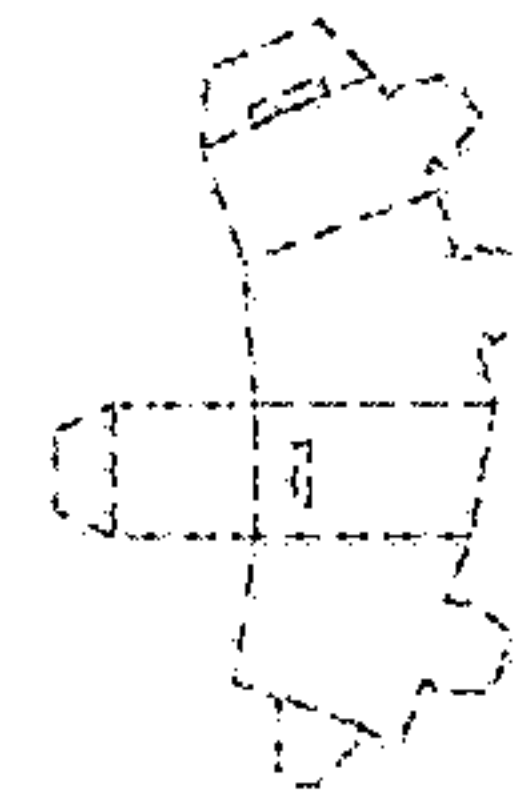

FIG. 14

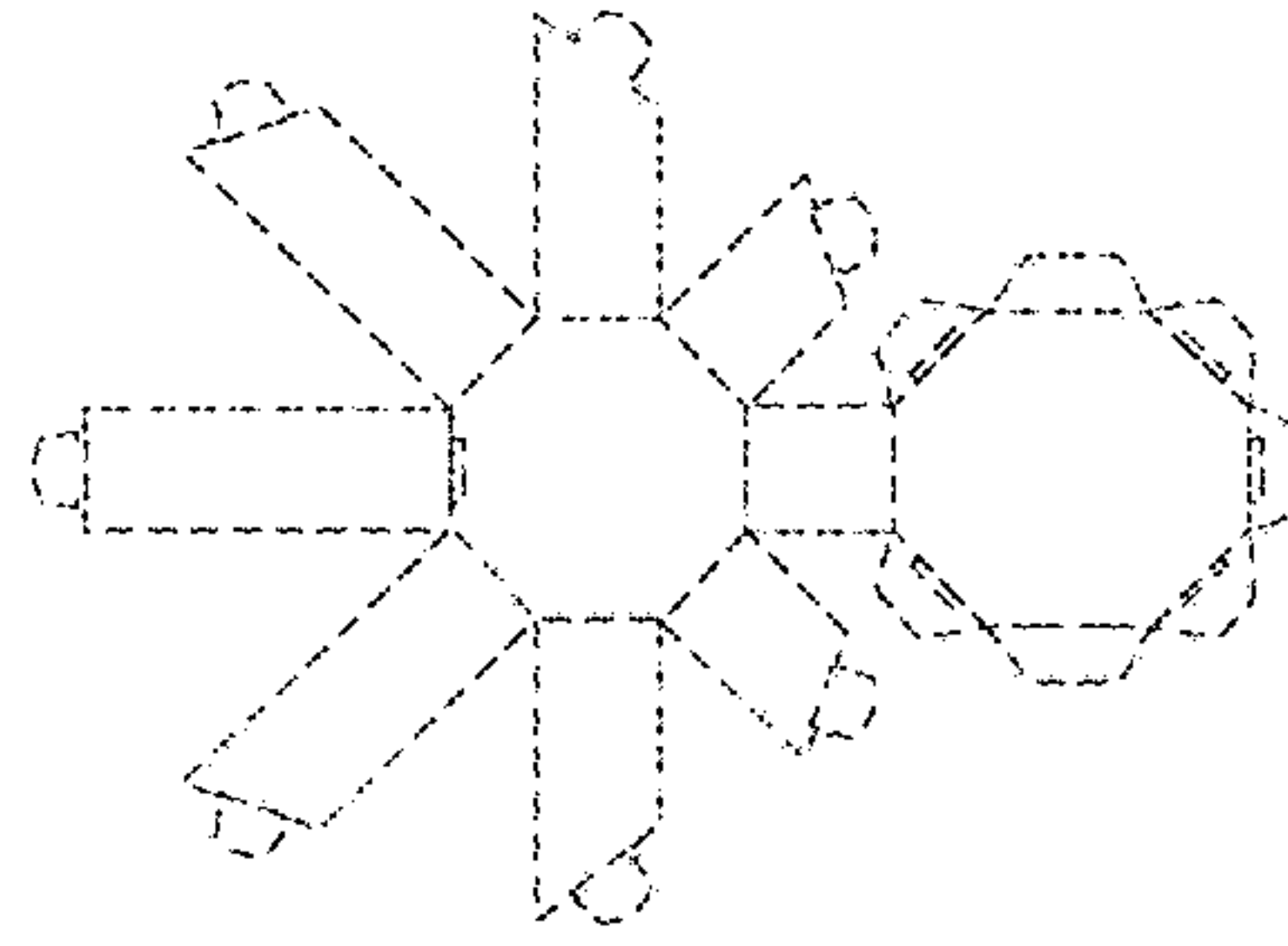

FIG. 15

FIG. 16

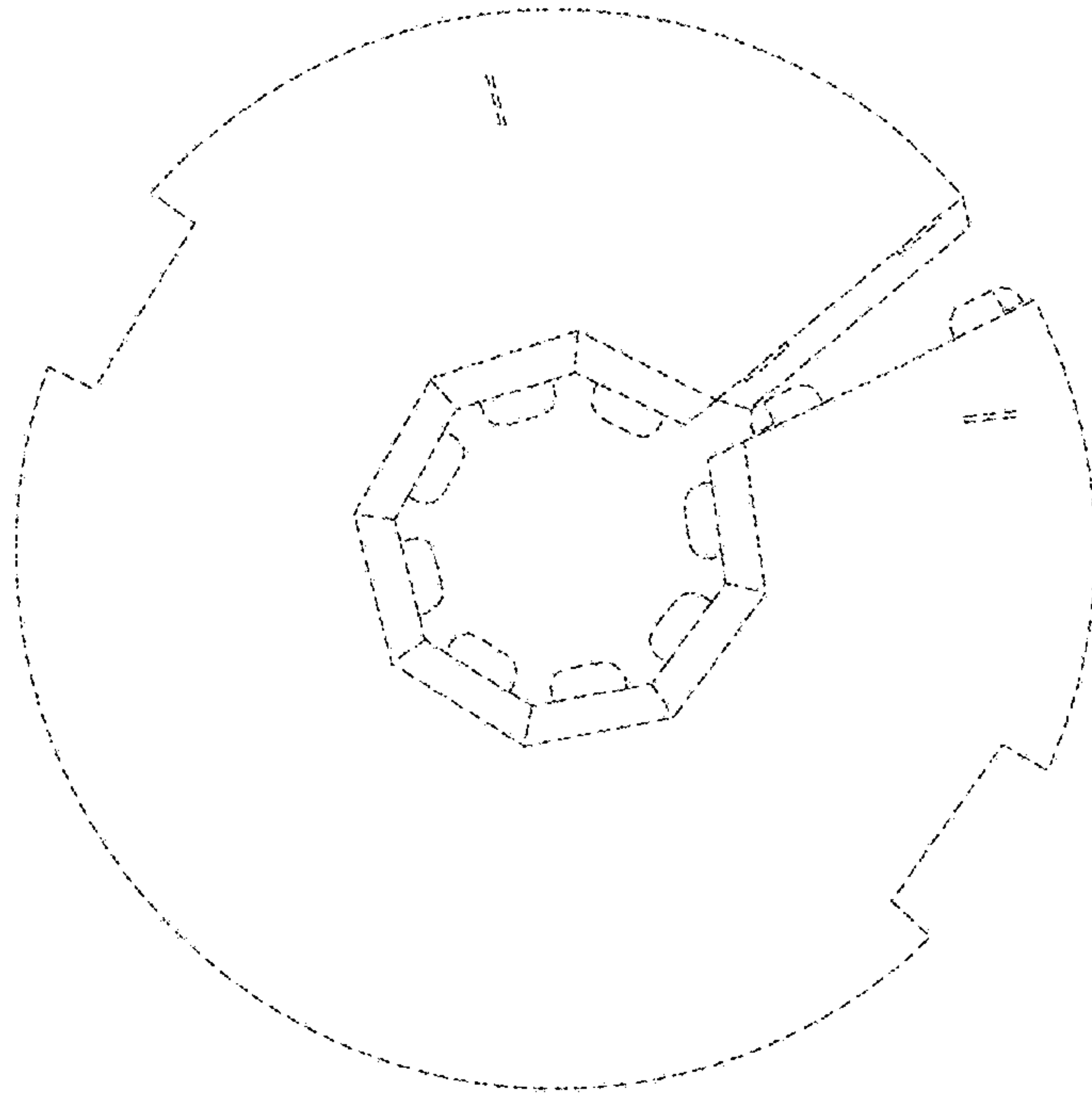

FIG. 18

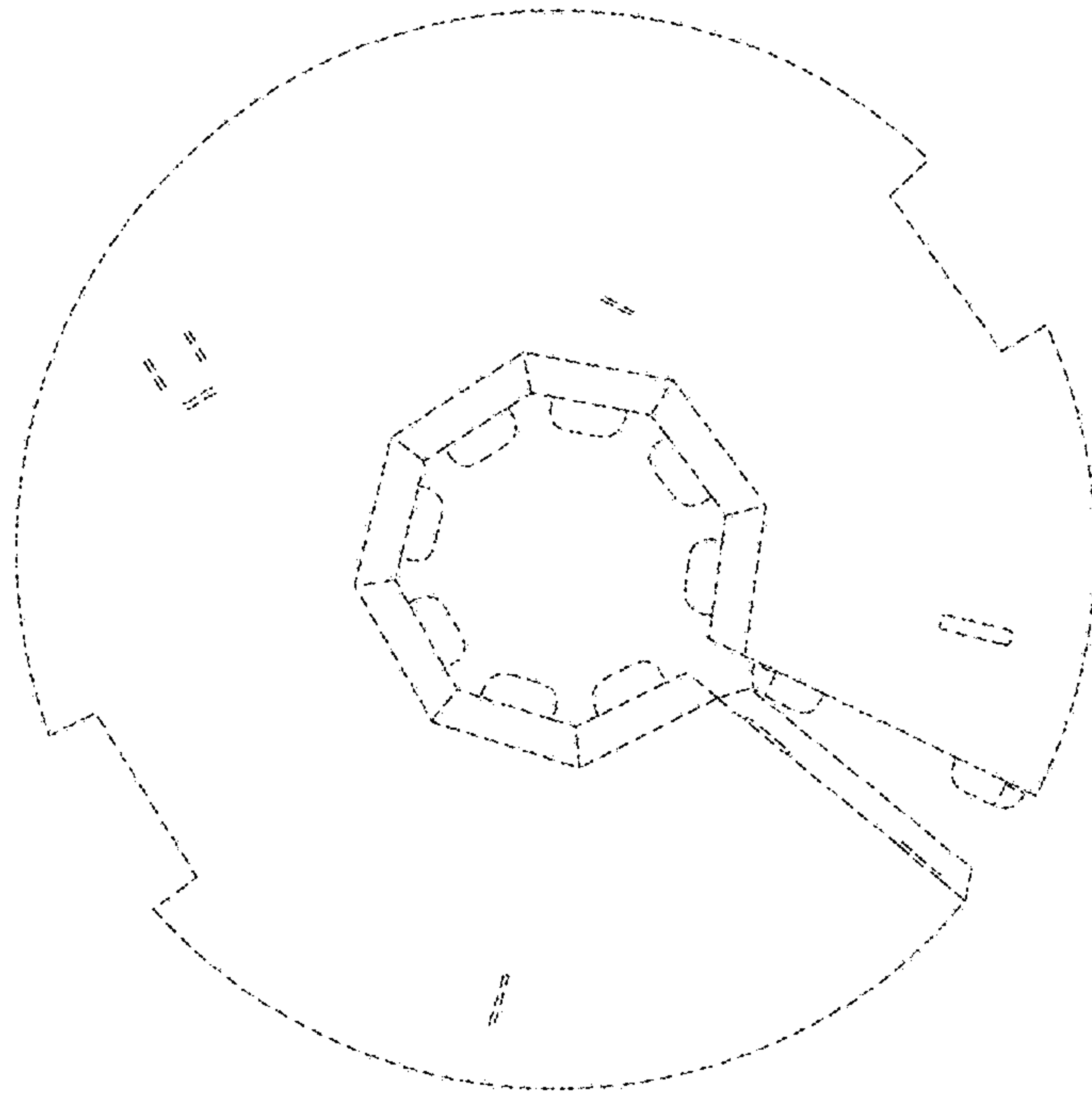

FIG. 17

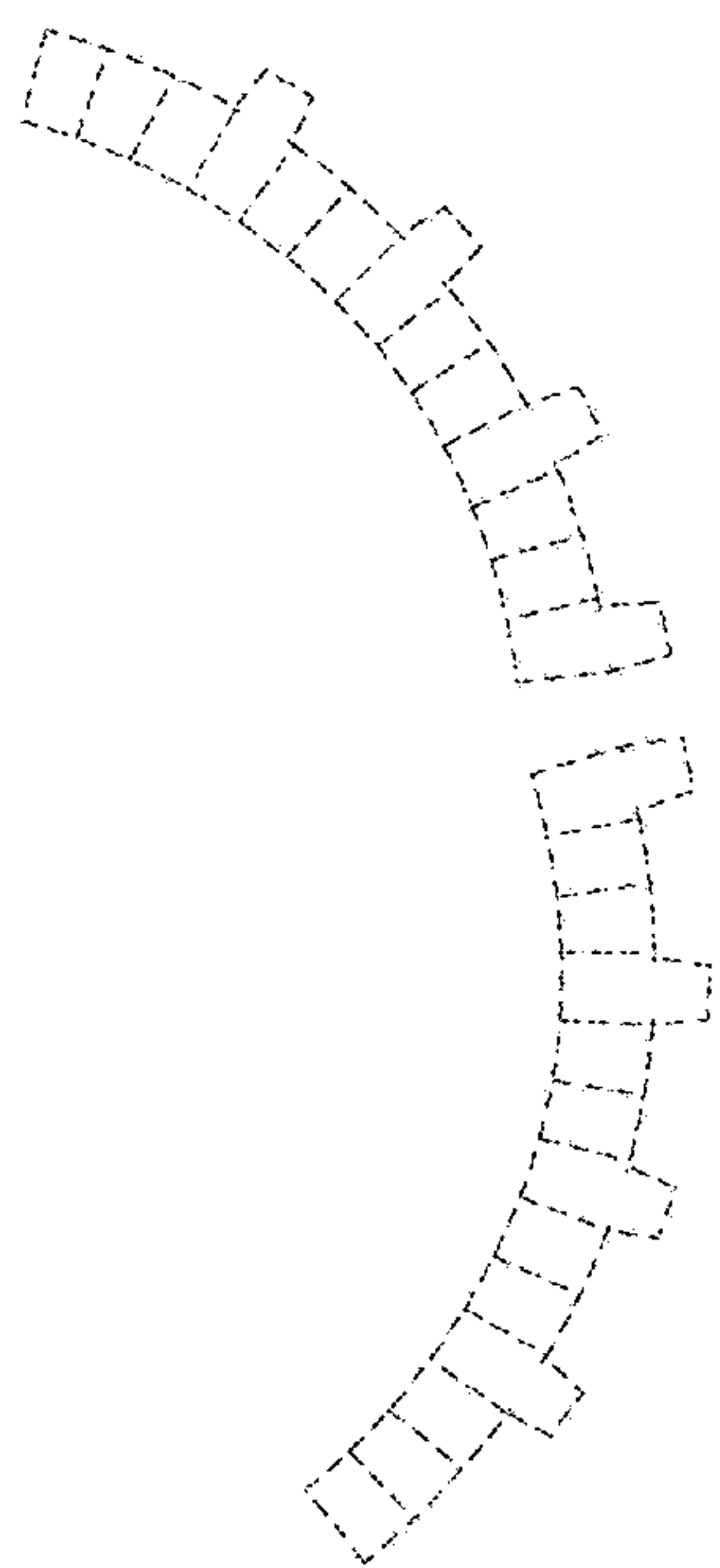

FIG. 19

FIG. 20

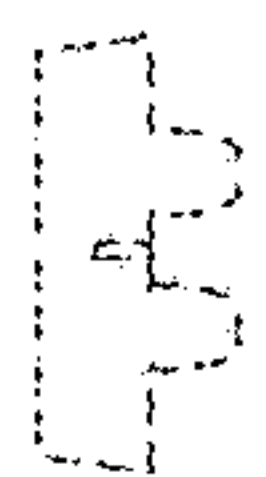

FIG. 22



FIG. 23

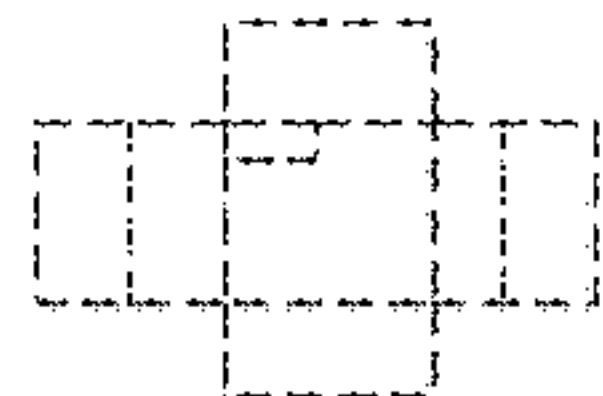

FIG. 24

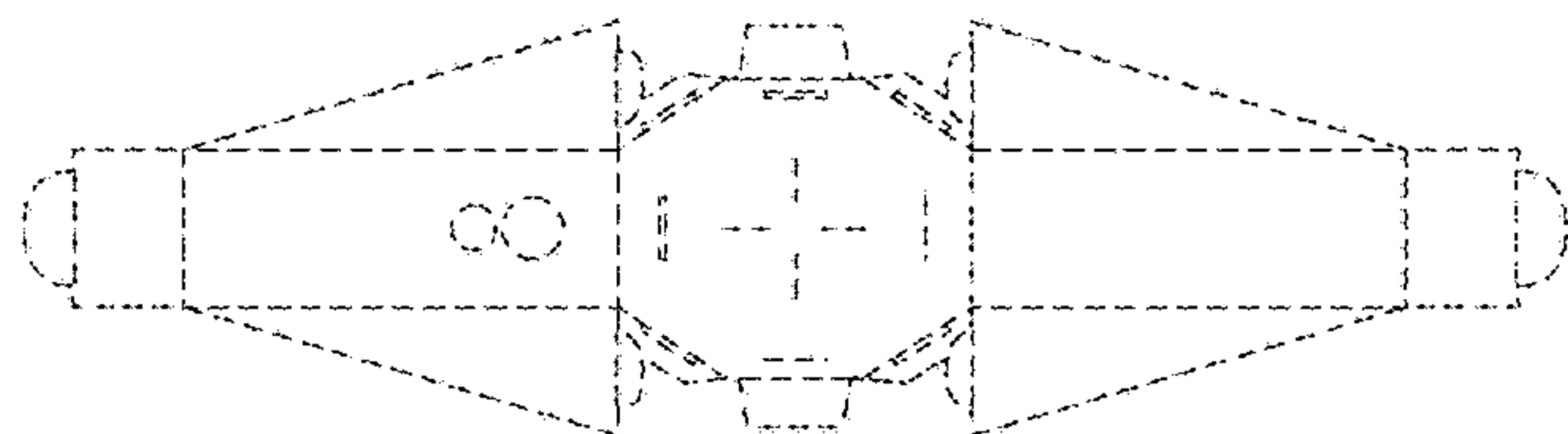

FIG. 21

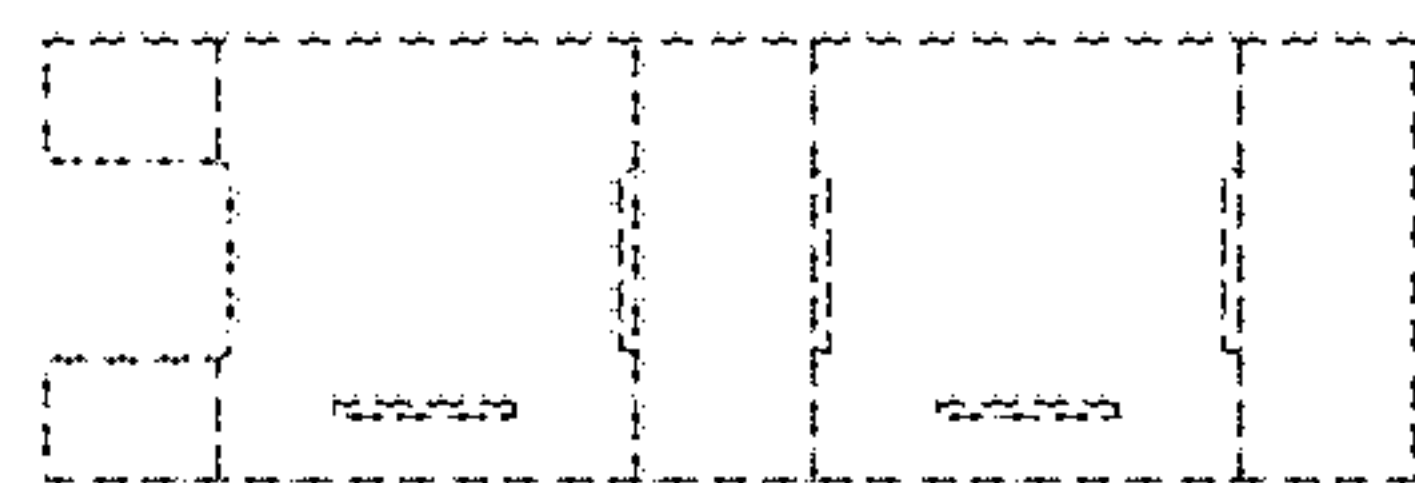

FIG. 25

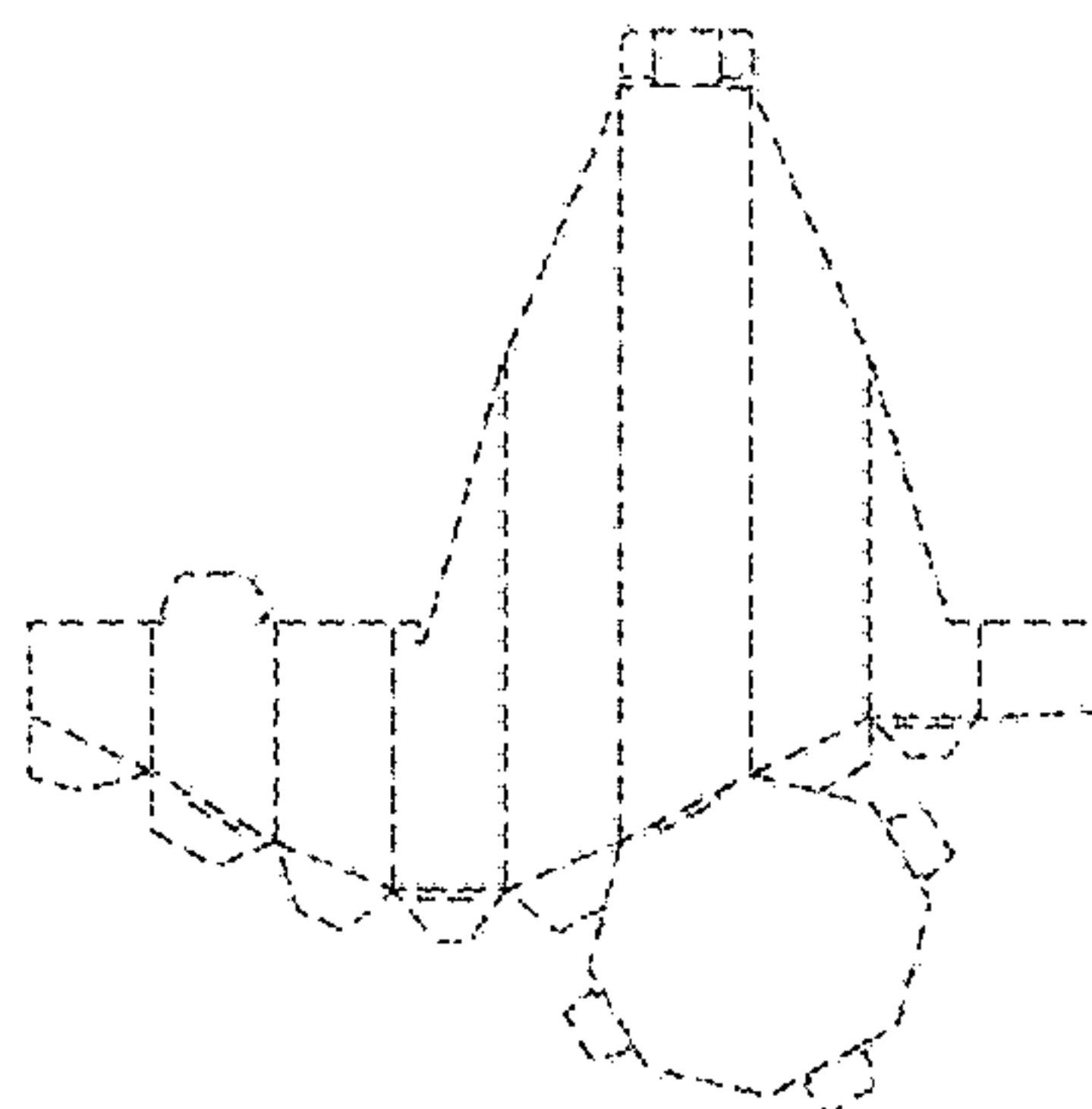

FIG. 26

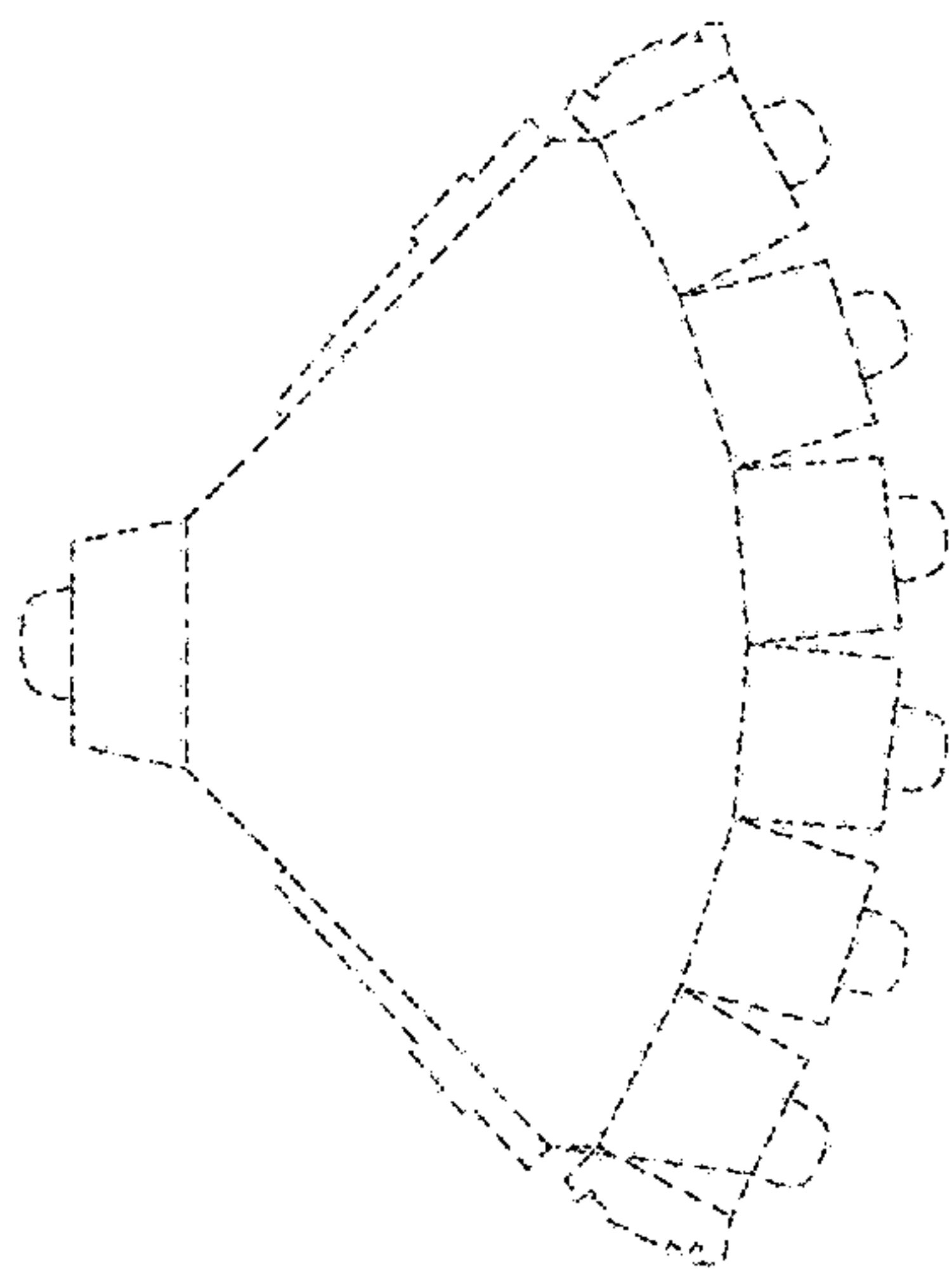

FIG. 27

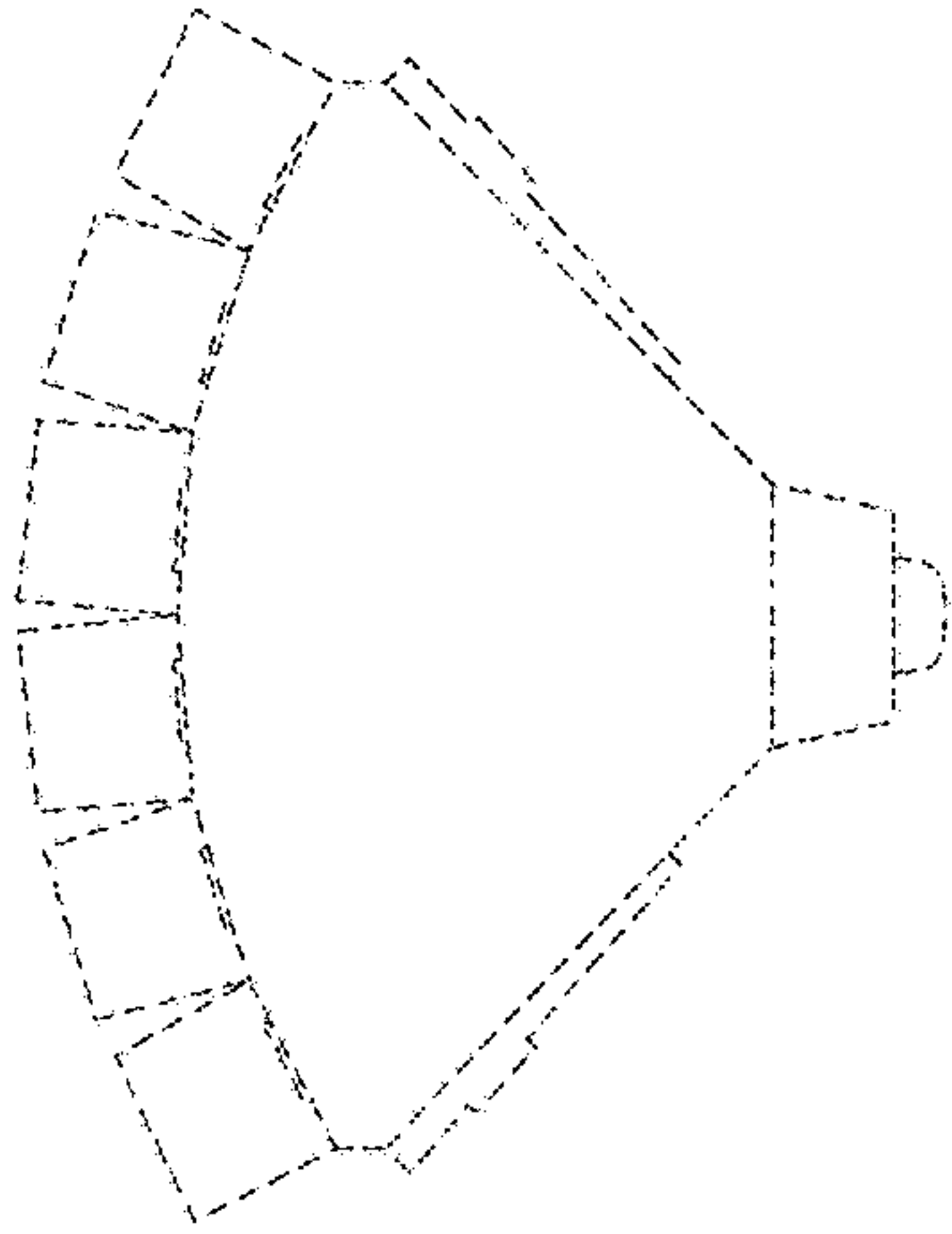

FIG. 28

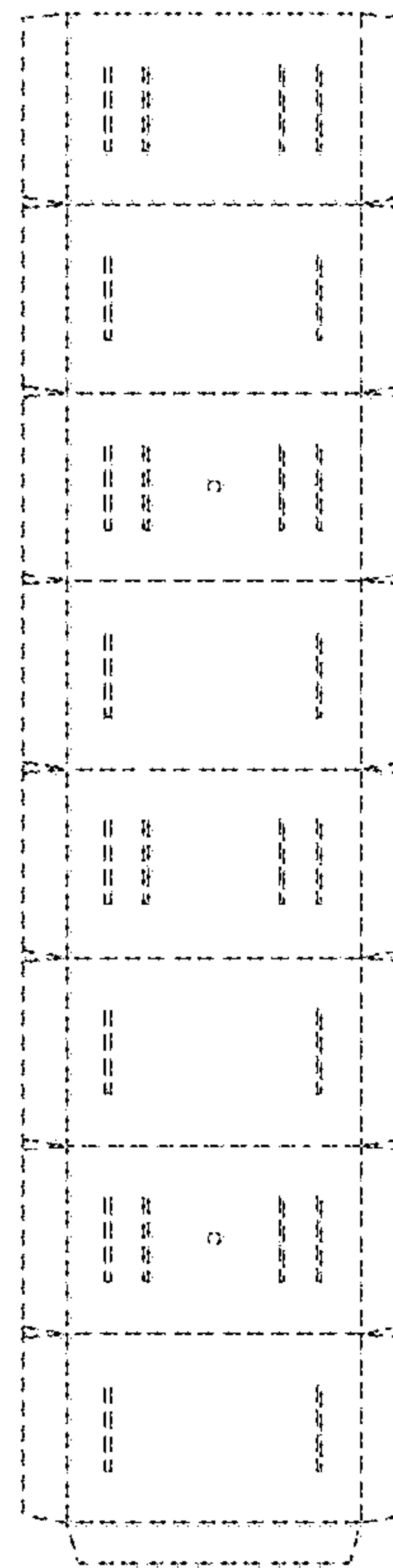

FIG. 29