



US00D860548S

(12) **United States Design Patent** (10) **Patent No.:** **US D860,548 S**
Hicks et al. (45) **Date of Patent:** **** Sep. 17, 2019**

(54) **ANIMAL EAR TAG**

(71) Applicant: **HERDX, INC.**, Boerne, TX (US)

(72) Inventors: **Ronald B. Hicks**, Boerne, TX (US);
Sarah C. Harkleroad, San Antonio, TX (US)

(**) Term: **15 Years**

(21) Appl. No.: **29/624,254**

(22) Filed: **Oct. 31, 2017**

(51) **LOC (12) Cl.** **30-08**

(52) **U.S. Cl.**
USPC **D30/155**; D30/199

(58) **Field of Classification Search**
USPC D30/155, 199; D19/10; D20/43, 22;
40/300, 301, 1.5, 668, 304, 302, 622,
40/309, 664, 663, 662; 119/655, 814;
411/531, 500, 509, 508, 511, 530;
606/117, 116, 151, 213, 215, 220, 153,
606/185; D8/394, 373; D11/81, 116, 61,
D11/86, 44, 46, 226, 17, 221, 229, 223,
D11/220, 222, 99, 95, 88; 24/114.4,
24/114.11, 114.12, 113 R, 113 MP, 47,
24/711.1, 620, 704, 102 R; 2/265;
340/572.1, 573.3, 572.8, 573.1, 572.9,
340/693.5, 693.9; D21/389, 390, 385,
D21/370; D24/101-103; D1/114, 127;
426/104; 273/282.1, 260, 290; D3/211;
D34/31, 35; D13/183, 171, 174;
D14/456; 248/309.4; 428/900; D9/772,
D9/741; D32/61, 35; D15/144; 63/12,
63/13, 29.1; 343/788; 29/512, 522.1;
424/422; 604/891.1; 285/915; 264/255,
264/272.11; 335/285, 296, 303;
D10/106.9, 106.91, 106.92
CPC A01K 11/00; A01K 11/001-004; A01K
11/006; A01K 11/008; A01K 29/005
See application file for complete search history.

(56) **References Cited**

U.S. PATENT DOCUMENTS

D243,621 S * 3/1977 Sulik D30/155
D253,731 S * 12/1979 Mayfield D30/155
4,176,482 A * 12/1979 Steckel A01K 11/001
40/301
4,718,697 A * 1/1988 Berardus van Amelsfort
A01K 11/006
206/309
4,750,284 A * 6/1988 Parry A01K 11/001
119/655
D299,038 S * 12/1988 van Amelsfort D20/27
D337,397 S * 7/1993 Kerola D30/155
(Continued)

OTHER PUBLICATIONS

SCR by Allflex ESense Flex Ear Tag, Bovine Vet Online: <https://www.bovinevetonline.com/article/allflex-wins-two-dairy-herd-management-innovation-awards-world-dairy-expo>, 2017 (Year: 2017).*

(Continued)

Primary Examiner — Susan Moon Lee
(74) *Attorney, Agent, or Firm* — Jackson Walker LLP

(57) **CLAIM**
We claim the ornamental design for an animal ear tag, as shown and described.

DESCRIPTION

FIG. 1 is a top, front, left perspective view of an animal ear tag according to our design;
FIG. 2 is a front view thereof;
FIG. 3 is a back view thereof;
FIG. 4 is a right view thereof;
FIG. 5 is a left view thereof;
FIG. 6 is a top view thereof; and,
FIG. 7 is a bottom view thereof.
The broken lines depict unclaimed features of the animal ear tag that are shown for purposes of illustration and that form no part of the design claim.

1 Claim, 5 Drawing Sheets

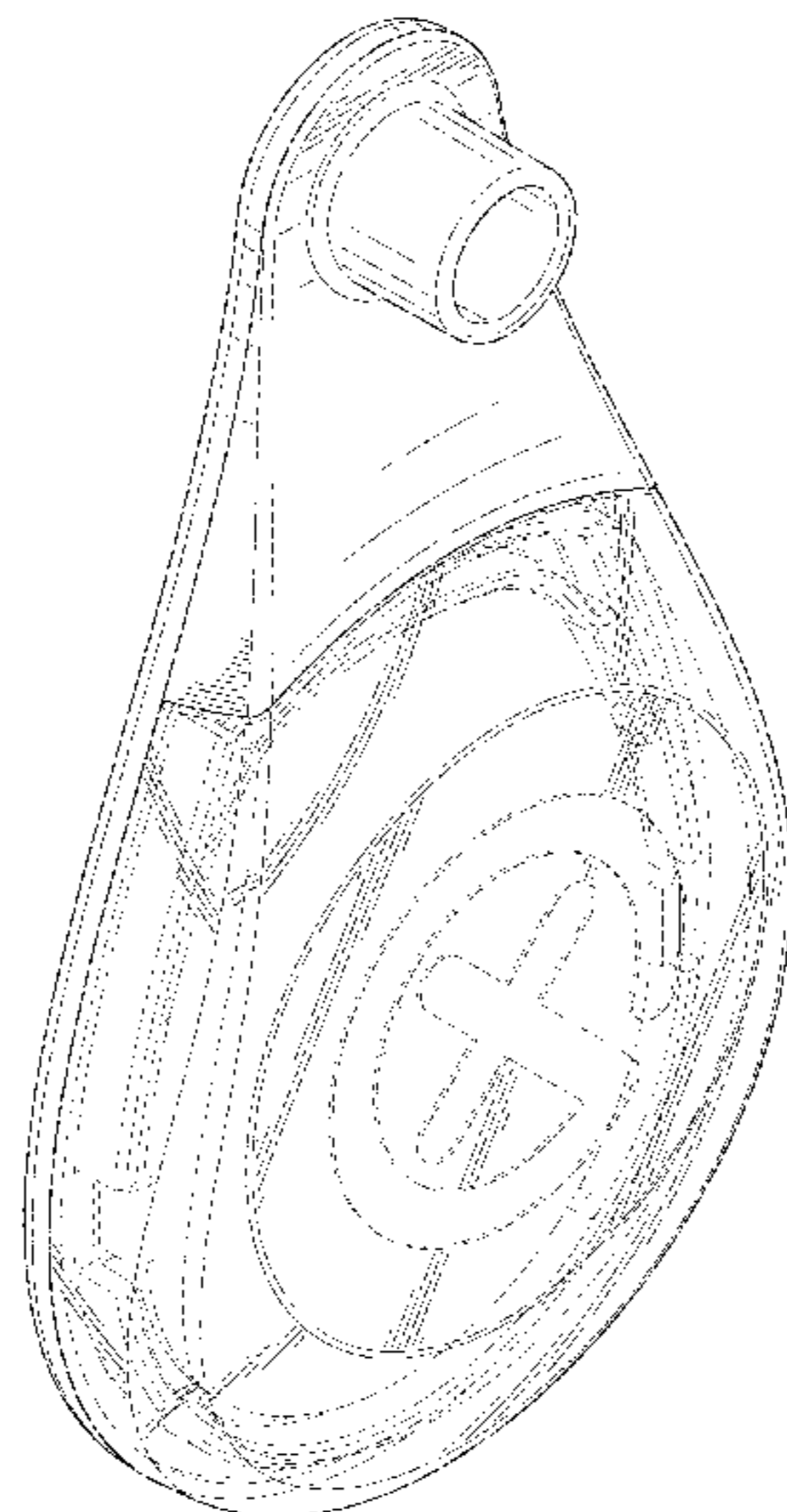

(56)

References Cited

U.S. PATENT DOCUMENTS

5,357,700 A * 10/1994 Schulte A01K 11/004
40/300
5,461,806 A * 10/1995 Bristow, Jr. A01K 11/001
40/301
5,461,807 A * 10/1995 Johnson A01K 11/004
40/300
D379,253 S * 5/1997 Knapp D30/155
D393,490 S * 4/1998 Burch D20/42
6,510,630 B1 1/2003 Gardner
D670,043 S * 10/2012 Goldman D30/155
2002/0095828 A1 * 7/2002 Koopman A01K 11/004
40/301
2003/0121188 A1 * 7/2003 Haar A01K 11/001
40/301
2003/0182831 A1 * 10/2003 Haar A01K 11/001
40/301
2004/0079010 A1 * 4/2004 Crespo A01K 11/004
40/301
2005/0145187 A1 * 7/2005 Gray A01K 11/008
119/174

2007/0006494 A1 * 1/2007 Hayes A01K 11/001
40/301
2013/0175347 A1 * 7/2013 Decaluwe A01K 11/004
235/492
2016/0192622 A1 * 7/2016 Yeum A01K 11/004
40/301
2017/0156288 A1 6/2017 Singh
2017/0170850 A1 * 6/2017 Deng A01K 11/008
2017/0318781 A1 * 11/2017 Rollins G06K 19/0723
2018/0020641 A1 * 1/2018 Holman A01K 19/00
119/822
2018/0098522 A1 * 4/2018 Steinfert A01K 11/001
2018/0249679 A1 * 9/2018 Candy A01K 11/004
2019/0059335 A1 * 2/2019 Crider, Jr. A01K 29/005
2019/0059741 A1 * 2/2019 Crider, Jr. A61B 5/0008

OTHER PUBLICATIONS

Corathon Insecticide Tags by Bayer Healthcare, LLC; Leedstone.com; Sep. 26, 2017 Sep. 26, 2017.

* cited by examiner

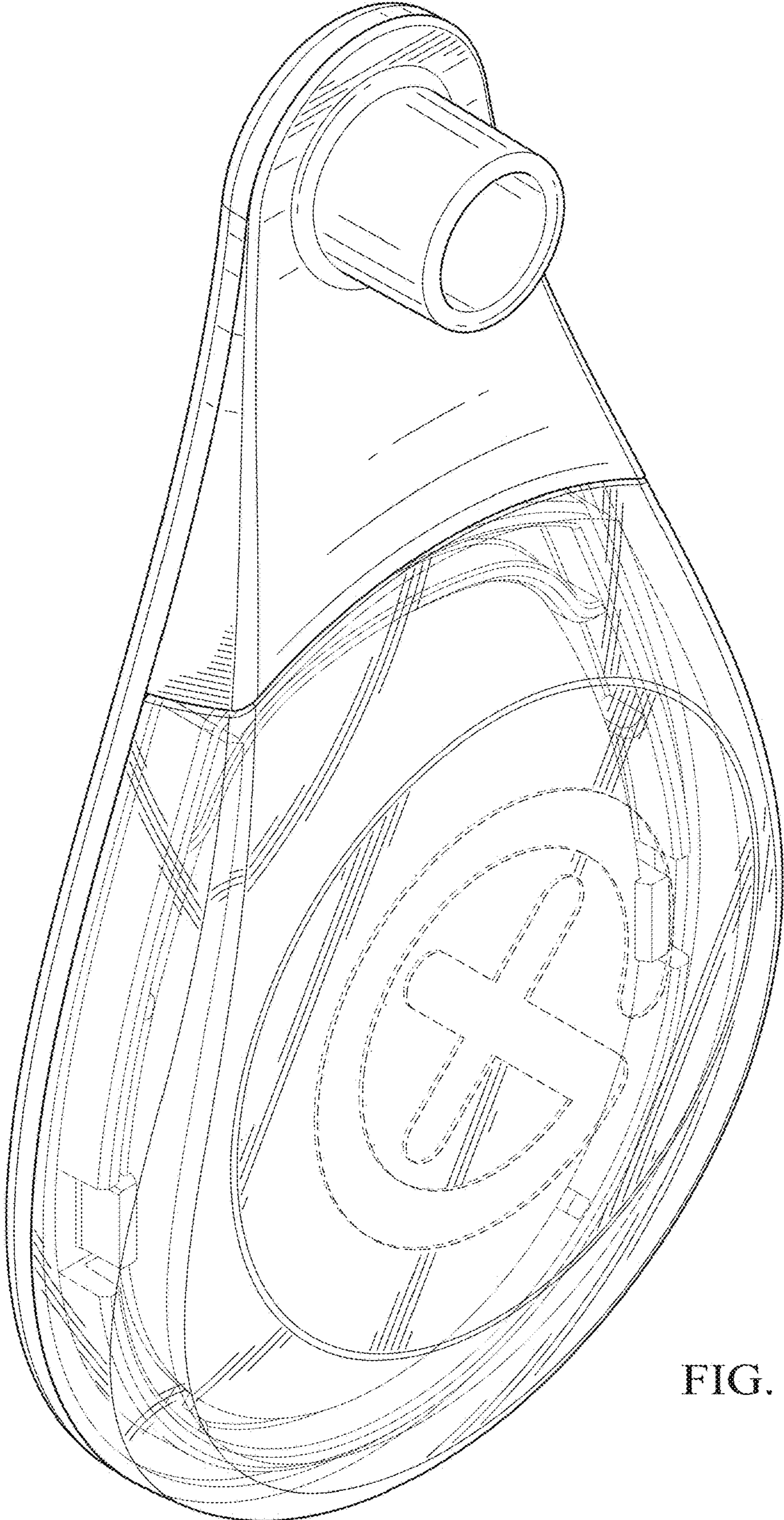

FIG. 1

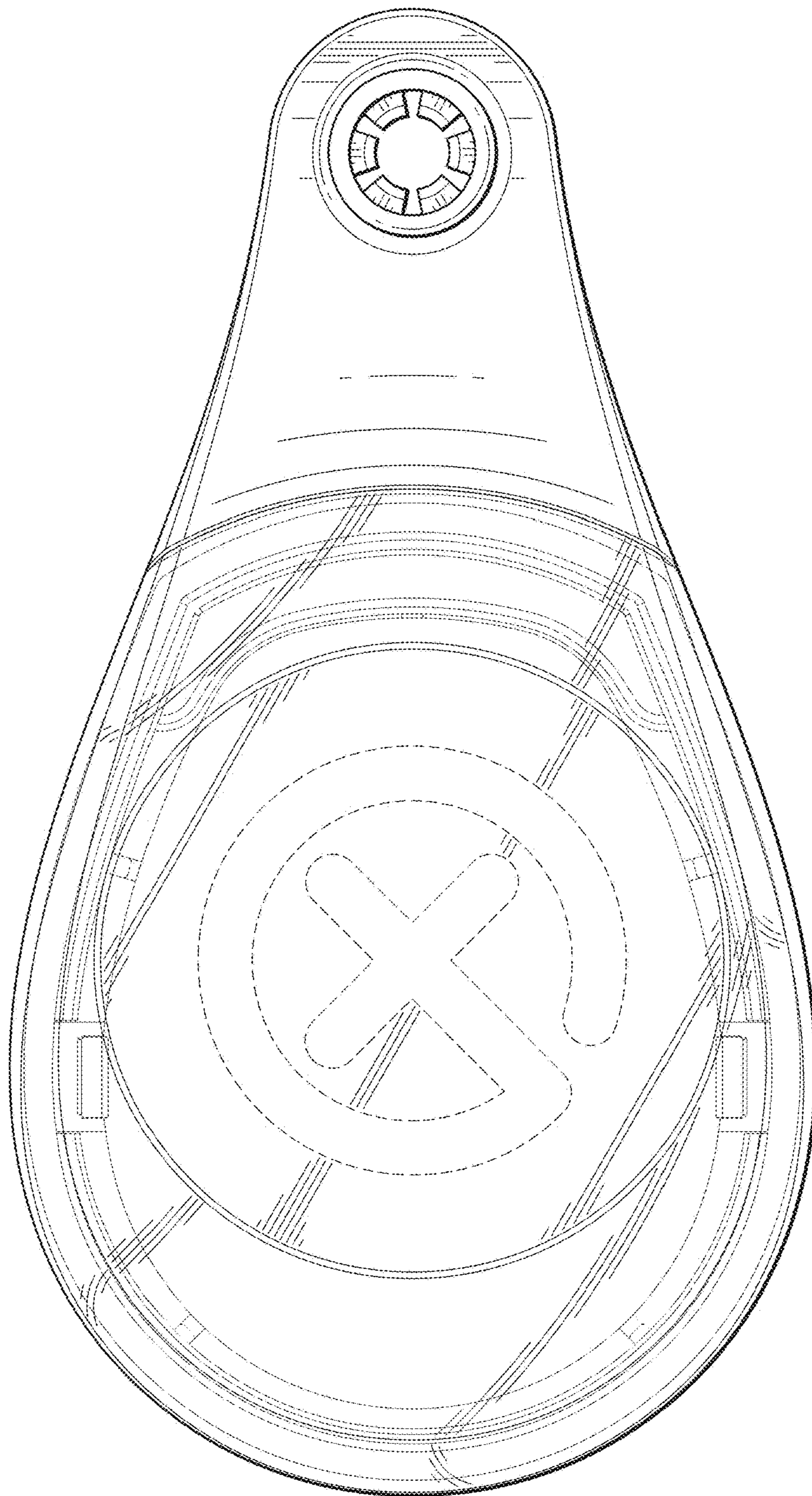

FIG. 2

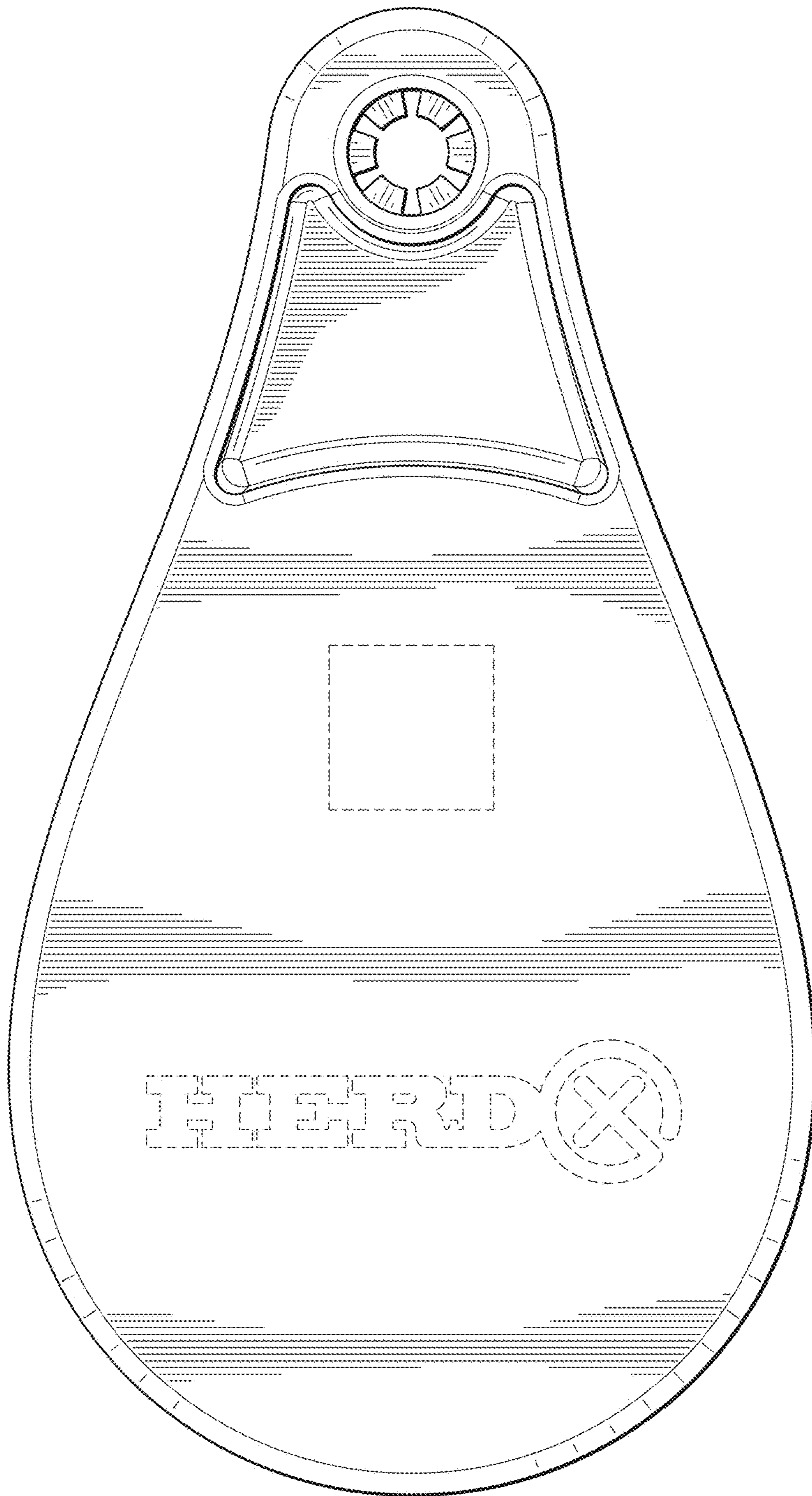

FIG. 3

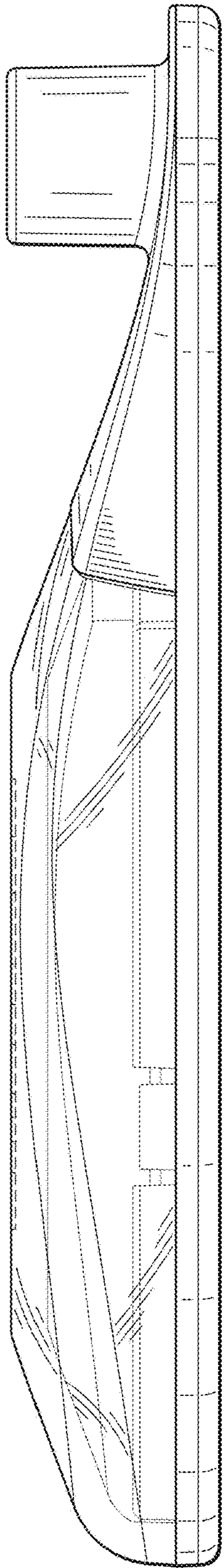

FIG. 4

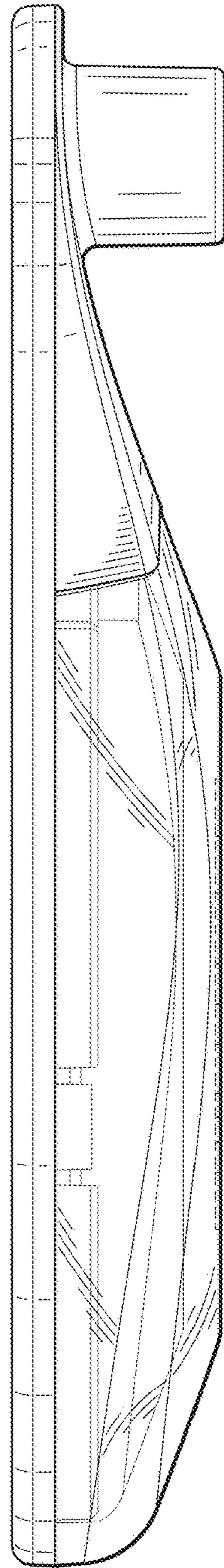

FIG. 5

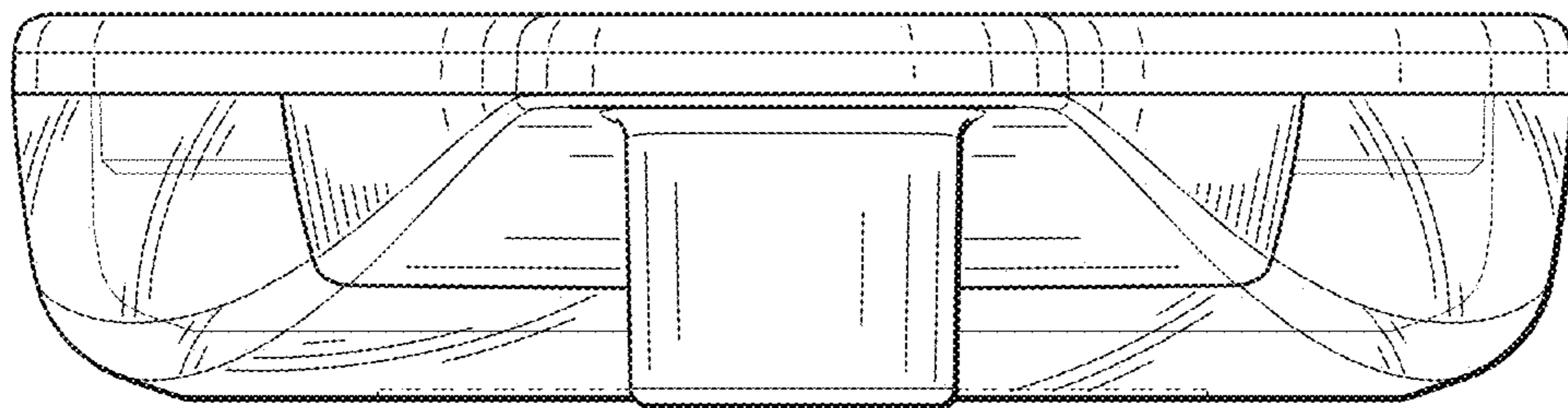

FIG. 6

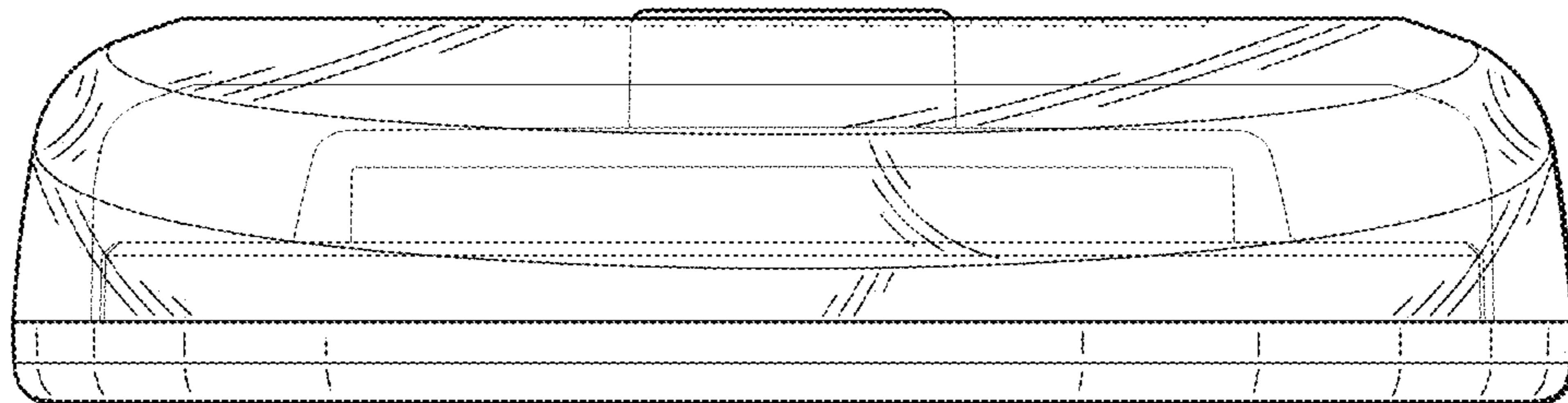

FIG. 7