

US00D860546S

(12) **United States Design Patent** (10) **Patent No.:** **US D860,546 S**
Rosca et al. (45) **Date of Patent:** **** Sep. 17, 2019**

(54) **TOP SHELL FOR HELMET**
(71) Applicant: **LINCOLN GLOBAL INC.**, Santa Fe Springs, CA (US)
(72) Inventors: **Mircea Rosca**, Santa Fe Springs, CA (US); **Jamy Bulan**, Santa Fe Springs, CA (US); **Ziqian Wu**, Nanjing (CN)
(73) Assignee: **LINCOLN GLOBAL, INC.**, Sante fe Springs, CA (US)

5,103,815 A 4/1992 Siegel
D332,442 S 1/1993 Simpson
5,230,101 A 7/1993 Hedges
5,461,731 A 10/1995 Shida
5,619,989 A 4/1997 Kruger
(Continued)

FOREIGN PATENT DOCUMENTS

DE 102009056511 A1 6/2011
EP 1228798 A1 8/2002
(Continued)

(**) Term: **15 Years**
(21) Appl. No.: **29/639,566**
(22) Filed: **Mar. 7, 2018**
(51) **LOC (12) Cl.** **29-02**
(52) **U.S. Cl.**
USPC **D29/110; D29/122**
(58) **Field of Classification Search**
USPC D29/110, 102, 106, 107, 122, 108;
D24/110.1, 110.2, 110.3
CPC .. A61F 9/06; A61F 9/061; A61F 9/064; A61F
9/065; A61F 9/067; A61F 9/068
See application file for complete search history.

OTHER PUBLICATIONS

3M TM Versaflo TM Powered Air Purifying Respirator TR-600; Heavy Industry Evolve to TR-600; 3M Personal Safety Division; pp. 1-3; estimated Jan. 2014.
(Continued)

Primary Examiner — Elizabeth J Oswecki

(57) **CLAIM**
The ornamental design for a top shell of a helmet, as shown and described.

DESCRIPTION

FIG. 1 is a perspective view of a top shell of a helmet showing our new design, in a used condition with a helmet shown in broken lines;
FIG. 2 is a front perspective view thereof;
FIG. 3 is a back perspective view thereof;
FIG. 4 is a front view thereof;
FIG. 5 is a back view thereof;
FIG. 6 is a right side view thereof;
FIG. 7 is a left side view thereof;
FIG. 8 is a top view thereof; and,
FIG. 9 is a bottom view thereof.
The broken lines shown in the drawings represent portions of the top shell for helmet that form no part of the claimed design.

(56) **References Cited**
U.S. PATENT DOCUMENTS
2,964,038 A 12/1960 Leslie
3,806,102 A 4/1974 Valenta
3,812,853 A 5/1974 Crain
3,982,095 A 9/1976 Robinson
4,113,627 A 9/1978 Leason
D255,029 S 5/1980 Brownlie
D259,954 S 7/1981 Reichl
4,414,172 A 11/1983 Leason
4,502,873 A 3/1985 Mottram
4,826,598 A 5/1989 Cain
5,063,926 A 11/1991 Forsgren
5,091,997 A 3/1992 Foehl

1 Claim, 9 Drawing Sheets

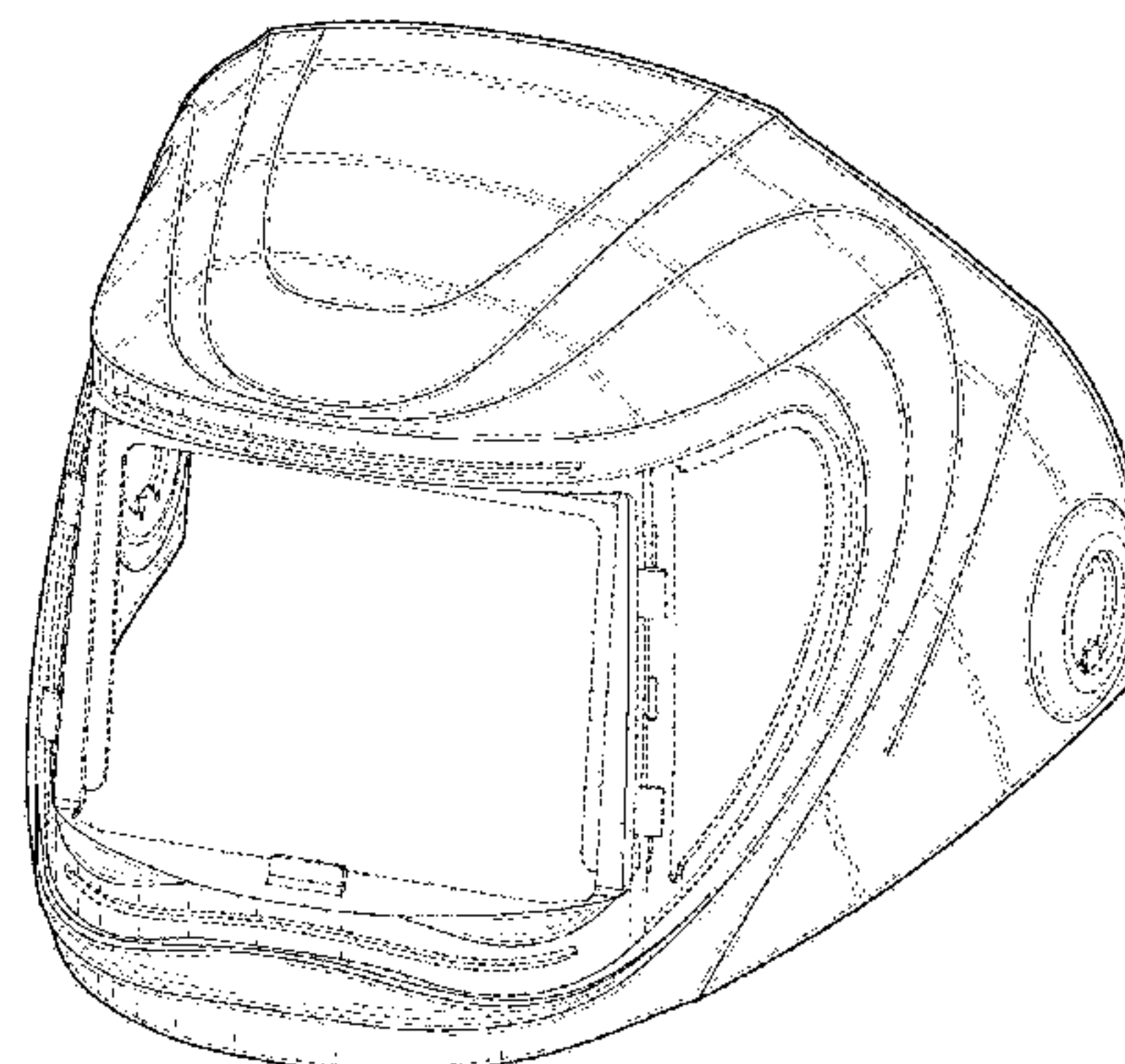
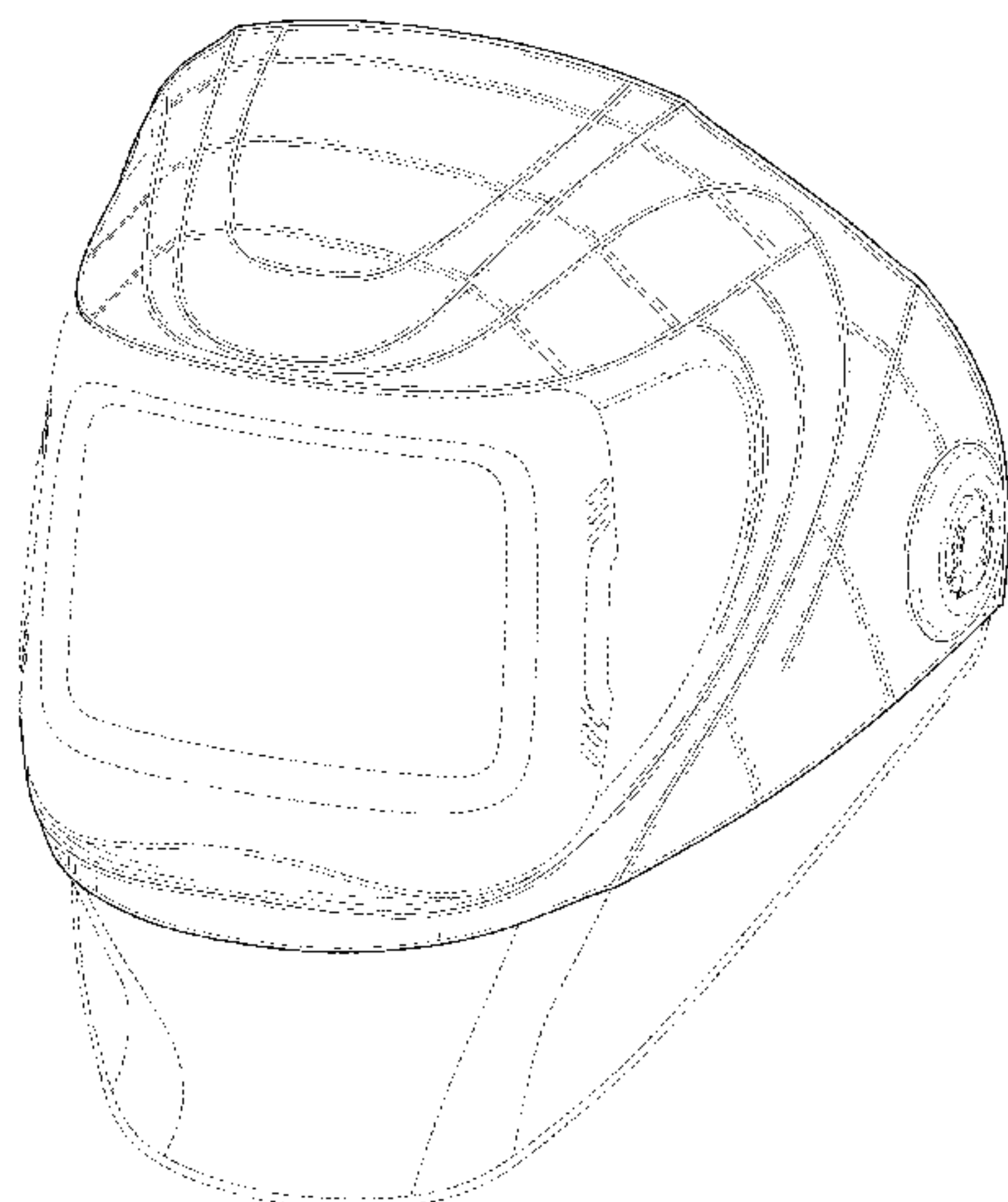

(56)

References Cited

U.S. PATENT DOCUMENTS

5,688,460 A	11/1997	Ruschke	
5,766,469 A	6/1998	Boast	
D398,421 S *	9/1998	Crafoord	D29/110
5,857,215 A *	1/1999	Ferguson	A61F 9/06 2/412
5,885,499 A	3/1999	Aksberg	
5,924,420 A	7/1999	Reischel	
D414,861 S	10/1999	Metzger	
D416,649 S	11/1999	Burns	
6,014,971 A	1/2000	Danish	
6,016,805 A	1/2000	Burns	
6,035,451 A	3/2000	Burns	
D423,518 S	4/2000	Milligan	
6,060,689 A	5/2000	Wilson	
6,062,221 A	5/2000	Brostrom	
6,081,931 A	7/2000	Burns	
6,102,033 A	8/2000	Baribeau	
6,123,077 A	9/2000	Bostock	
6,186,140 B1	2/2001	Hoague	
D439,878 S	4/2001	Arik	
6,248,280 B1	6/2001	Kern	
6,250,299 B1	6/2001	Danisch	
6,279,572 B1	8/2001	Danisch	
6,298,498 B1	10/2001	Burns	
D452,911 S	1/2002	Danielsson	
6,367,085 B1	4/2002	Berg	
6,403,008 B1	6/2002	Schann	
6,416,570 B2	7/2002	Goto	
6,438,763 B2	8/2002	Guay	
6,575,165 B1	6/2003	Cook	
D483,860 S	12/2003	Knoch	
6,666,209 B2	12/2003	Bennett	
D486,916 S	2/2004	Cheung	
D492,781 S	7/2004	Vielhaber	
D493,884 S	8/2004	Virr	
D498,527 S	11/2004	Virr	
D498,528 S	11/2004	Van Brunt	
6,895,960 B2	5/2005	Fabin	
D513,074 S	12/2005	Nakamura	
D526,413 S	8/2006	Baker	
7,093,302 B1	8/2006	Burns	
D528,212 S	9/2006	Conway	
D540,989 S *	4/2007	Huh	D29/110
D540,990 S *	4/2007	Huh	D29/110
7,197,774 B2	4/2007	Curran	
D544,598 S	6/2007	Lithgow	
D550,349 S	9/2007	Lithgow	
D557,406 S	12/2007	Lithgow	
D560,795 S	1/2008	Lithgow	
D561,893 S	2/2008	Gunaratnam	
D565,801 S *	4/2008	Curci	D29/110
D577,816 S	9/2008	Ungar	
D578,204 S	10/2008	Lithgow	
D561,891 S	12/2008	Lithgow	
D584,003 S *	12/2008	Juhlin	D29/110
D585,131 S	1/2009	Trevor-Wilson	
D585,540 S	1/2009	Lithgow	
D586,051 S *	2/2009	Martin	D29/110
D586,956 S *	2/2009	Huh	D29/110
D589,138 S	3/2009	Kenyon	
D590,494 S	4/2009	Lithgow	
D592,301 S	5/2009	Cork	
7,594,278 B2	9/2009	Huh	
D604,853 S	11/2009	Abel	
D612,480 S	3/2010	Cork	
7,748,381 B2	7/2010	Croll	
D627,044 S	11/2010	Virr	
7,841,026 B2	11/2010	Makris	
7,865,968 B2	1/2011	Lilenthal	
D632,375 S	2/2011	Curran	
D643,114 S	8/2011	Virr	
D644,319 S	8/2011	Virr	
D647,209 S	10/2011	Muller	
8,056,152 B2	11/2011	Brace	
8,082,600 B2	12/2011	Morin	
D652,931 S	1/2012	Petteway	
8,104,094 B2	1/2012	Uttrachi	
D654,224 S *	2/2012	Wu	D29/110
D654,225 S *	2/2012	Wu	D29/110
D654,226 S *	2/2012	Wu	D29/110
D654,634 S *	2/2012	Wu	D29/110
D657,445 S	4/2012	Curran	
8,172,190 B2	5/2012	Dang	
D662,672 S	6/2012	Carlburg	
D663,412 S	7/2012	Virr	
D666,288 S	8/2012	Bainton	
D667,126 S	9/2012	Cho	
D668,326 S	10/2012	Bainton	
8,336,113 B2	12/2012	Uttrachi	
D673,477 S	1/2013	Szellos	
D675,789 S	2/2013	Wanhainen	
8,387,162 B2	3/2013	Huh	
D679,374 S	4/2013	Virr	
D679,375 S	4/2013	Kenyon	
D680,641 S	4/2013	Dwyer	
D681,190 S	4/2013	Dwyer	
D682,418 S	5/2013	Krepel	
8,505,121 B2	8/2013	Ahlgren	
D690,413 S	9/2013	Abel	
8,584,265 B2	11/2013	Lilenthal	
D696,766 S	12/2013	Maurer	
8,627,517 B2	1/2014	Ahlgren	
8,745,770 B2	6/2014	Ahlgren	
8,806,662 B2	8/2014	Huh	
8,821,621 B2	9/2014	Dwyer	
8,839,788 B2	9/2014	Betz	
8,875,318 B2	11/2014	Huh	
D722,696 S	2/2015	Blomquist	
8,955,162 B2	2/2015	Huh	
D723,698 S	3/2015	Cockley	
D724,197 S	3/2015	Hughes	
D728,163 S *	4/2015	Zhou	D29/110
D728,777 S	5/2015	Spear	
D730,528 S	5/2015	Yang	
D744,108 S	5/2015	Verma	
D731,123 S	6/2015	Spear	
D732,670 S	6/2015	Dwyer	
9,066,552 B2	6/2015	Ahlgren	
D745,137 S	12/2015	Pipe	
D746,438 S	12/2015	Dwyer	
D752,228 S	3/2016	Verma	
D753,345 S *	4/2016	Yang	D29/110
D756,519 S	5/2016	Adams	
D760,902 S	7/2016	Persson	
D762,846 S	8/2016	Fehr	
D763,437 S	8/2016	Dwyer	
D765,237 S	8/2016	Danford	
D767,754 S	9/2016	Danford	
D774,180 S	12/2016	Wu	
D775,346 S	12/2016	Beth	
D776,256 S	1/2017	Formica	
D776,802 S	1/2017	Loew	
D779,674 S	2/2017	Blomberg	
D780,906 S	3/2017	Engelbreth	
D782,694 S	3/2017	Wainwright	
D783,792 S	4/2017	Goransson	
D785,161 S	4/2017	Dravitzki	
D785,780 S	5/2017	Scarborough	
D786,443 S	5/2017	Blomberg	
D788,988 S *	6/2017	Zhou	D29/110
D788,989 S *	6/2017	Zhou	D29/110
D789,614 S *	6/2017	Huh	D29/110
D790,685 S	6/2017	Silkaitis	
D790,883 S	6/2017	Formica	
D791,303 S	7/2017	Pipe	
D791,329 S	7/2017	Verma	
D793,626 S *	8/2017	Yang	D29/110
D834,754 S *	11/2018	Ambring	D29/110
D835,352 S *	12/2018	Ambring	D29/110
2007/0079417 A1 *	4/2007	Huh	A61F 9/065 2/8.2
2008/0060102 A1 *	3/2008	Matthews	A61F 9/061 2/8.2

(56)

References Cited

U.S. PATENT DOCUMENTS

2012/0260918 A1 10/2012 Sayers et al.
 2013/0206139 A1 8/2013 Krepel et al.
 2013/0206806 A1 8/2013 Hu et al.

FOREIGN PATENT DOCUMENTS

EP 1350550 A1 10/2003
 GB 2156232 A 10/1985

OTHER PUBLICATIONS

3M TM Versaflo TM Powered Air Purifying Respirator TR-600; Pharmaceutical to TR-600; 3M Personal Safety Division; pp. 1-3; estimated Jan. 2014.

3M TM Versaflo TM Powered Air Purifying Respirator TR-600; Evolve to TR-600; 3M Personal Safety Division; pp. 1-2; estimated Jan. 2014.

Powered Air -Purifying Respirator (PAPR); OM-234 936 Rev K; Owners Manual; www.MillerWelds.com; pp. 1-44; estimated Jan. 2014.

PAPR Powered Air Purifying Respirator; "The Power of the Blue"; Welding Protection; Miller Electric Mfg. Co.; www.MillerWelds.com; pp. 1-2; Apr. 2009.

3M TM Personal Safety Division; 3M TM Versaflo TM Powered Air Purifying Respirator TR-600 brochure, Evolve to TR-600, pp. 1-6, estimated Jan. 2014.

3M TM Personal Safety Division; The New 3M TM Versaflo TM Powered Air Purifying Respirator TR-600 brochure, Evolve to TR-600—Heavy Industry, pp. 1-4, estimated Jan. 2014.

3M TM Personal Safety Division; The New 3M TM Versaflo TM Powered Air Purifying Respirator TR-600 brochure, Evolve to TR-600—Pharmaceutical, pp. 1-4, estimated Jan. 2014.

3M TM Versaflo TM Respirator Systems for Healthcare Professionals; Comfort and Simplicity Versatility; 3M.com/Versaflo; pp. 1-4; estimated Jan. 2014.

3M TM Versaflo TM Respirator Systems for Pharmaceutical Applications; Comfort Simplicity Versatility; pp. 1-2; estimated Jan. 2014.

3M TM Versaflo TM Respirator Systems; Comfort Simplicity Versatility; pp. 1-8; estimated Jan. 2014.

3M TM Versaflo TM S-Series Hoods and Headcovers for powered and Supplied Air Respirators; Comfort Simplicity Versatility; pp. 1-12; estimated Jan. 2014.

3M TM Versaflo TM TR-300 Powered Air Purifying Respirators; Protection from Particles; Comfort Simplicity Versatility; pp. 1-4; estimated Jan. 2014.

PAPR Powered Air Purifying Respirator; Welding Protection; Miller Electric Mfg. Co.; pp. 1-2; estimated Jan. 2014.

3M Air-Mate; Powered Air Purifying Respirator (PAPR) product matrix; pp. 1-3; estimated Jan. 2015.

3M Versaflo M-Series Headgear for Powered and Supplied Air Respirators; pp. 1-8; estimated Jan. 2015.

3m Speedglas Welding Safety Catalog; pp. 1-55, Jan. 2018.

Viking 1740 Ignition Welding Helmet; K4375; webpage retrieved on Mar. 28, 2018; pp. 1-2.

Viking 1840 All American Helmet; K3173-3; webpage retrieved on Mar. 28, 2018; pp. 1-2.

Viking 1840 Aztec Helmet; K4175-3; webpage retrieved on Mar. 28, 2018; pp. 1-2.

Viking 1840 Black Welding Helmet; K3023-3; webpage retrieved on Mar. 28, 2018; pp. 1-2.

Viking Auto Darkening Welding Helmets with 4C Lens Technology brochure; 2450 Model; The Lincoln Electric Company; Mar. 2017; pp. 1-8.

Viking 2450 All American Helmet; K3174-3; webpage retrieved on Mar. 28, 2018; pp. 1-2.

Viking 2450 All American Welding Helmet; K3230-3; webpage retrieved on Mar. 28, 2018; pp. 1-2.

Viking 2450 Black Digital Series Welding Helmet; K3028-3; webpage retrieved on Mar. 28, 2018; pp. 1-2.

Viking 2450 Graveyard Shift Welding Helmet; K3099-3; webpage retrieved on Mar. 28, 2018; pp. 1-2.

Viking 2450 Heavy Metal Welding Helmet; K3029-3; webpage retrieved on Mar. 28, 2018; pp. 1-2.

Viking 2450 Jessi The Welder Welding Helmet; K4437-3; webpage retrieved on Mar. 28, 2018; pp. 1-2.

Viking 2450 Street Rod Welding Helmet; K3035-3; webpage retrieved on Mar. 28, 2018; pp. 1-2.

Viking 2450 White Tail Welding Helmet; K3028-3; webpage retrieved on Mar. 28, 2018; pp. 1-2.

Viking 3350 All American Helmet; K3175-3; webpage retrieved on Mar. 28, 2018; pp. 1-2.

Viking 3350 Black Welding Helmet; K3034-3; webpage retrieved on Mar. 28, 2018; pp. 1-2.

Viking 3350 Code Red Welding Helmet; K4034-3; webpage retrieved on Mar. 28, 2018; pp. 1-2.

Viking 3350 Foose Imposter Welding Helmet; K3028-3; webpage retrieved on Mar. 28, 2018; pp. 1-2.

Viking 3350 Jessi vs. The Robot Welding Helmet; K3372-3; webpage retrieved on Mar. 28, 2018; pp. 1-2.

Viking 3350 MOJO Welding Helmet; K3101-3; webpage retrieved on Mar. 28, 2018; pp. 1-2.

Viking 3350 Motorhead Welding Helmet; K3100-3; webpage retrieved on Mar. 28, 2018; pp. 1-2.

Viking 3350 Polar Arc Welding Helmet; K3255-3; webpage retrieved on Mar. 28, 2018; pp. 1-2.

Viking 3350 Terracuda Welding Helmet; K3039-3; webpage retrieved on Mar. 28, 2018; pp. 1-2.

Viking 3350 Twisted Metal Welding Helmet; K3248-3; webpage retrieved on Mar. 28, 2018; pp. 1-2.

Viking 3350 White Tail Camo Welding Helmet; K4412-3; webpage retrieved on Mar. 28, 2018; pp. 1-2.

Viking 3350 Zombie Welding Helmet; K4158-3; webpage retrieved on Mar. 28, 2018; pp. 1-2.

Techman Freflow V3; Powered Air Purifying Respirator; Webpage retrieved on Mar. 28, 2018; pp. 1-3.

Techman Freflow V1; Powered Air Purifying Respirator; Webpage retrieved on Mar. 28, 2018; pp. 1-3.

Viking Industrial Passive; The Lincoln Company, Jun. 2014; pp. 1-2.

ITW 9400 Series Auto Darkening Welding Helmet Manual; Titanium Series; Miller Electric Company; estimated Jan. 2010; pp. 1-32.

ITW 9400i Series Auto Darkening Welding Helmet; Miller Electric Company; webpage retrieved Mar. 28, 2018; pp. 1-2.

ITW Elite—Auto Darkening Welding Helmets Elite Manual; Elite Series; Miller Electric Company; webpage retrieved Mar. 28, 2018; pp. 1-2.

ITW Elite Camouflage—Auto Darkening Welding Helmet; Elite Series; Miller Electric Company; webpage retrieved Mar. 28, 2018; pp. 1-2.

Translas Brochure; Airforce V3 Fresh Air Set; Multifunctional Flip-Up Design; by Welders for Welders—Translas.com; pp. 1-2; estimated Jan. 2018.

Translas Helmet & PAPR design webpage; www.translas.com:80/en/products/safety/helmets-papr/; webpage estimated Dec. 26, 2017.

Translas Catalog; by Welders for Welders; pp. 1-298; e.g., p. 272, estimated Jan. 2018.

ITW Elite Stars and Stripes Auto Darkening Welding Helmet; Elite Series; Miller Electric Company; webpage retrieved on Mar. 28, 2018; pp. 1-2.

Tecmen Passive Welding Helmet; Model ST100; webpage retrieved on Mar. 28, 2018; pp. 1-2.

Tecmen Passive Welding Helmet; Model ST200; webpage retrieved on Mar. 28, 2018; pp. 1-2.

Tecmen Auto Darkening Welding Helmet; iEASY Series; TM14-ADF735S; webpage retrieved on Mar. 28, 2018; pp. 1-2.

Tecmen Auto Darkening Welding Helmet; iWeld Series; TM14-ADF710S; webpage retrieved on Mar. 28, 2018; pp. 1-2.

Tecmen Auto Darkening Welding Helmet; iWeld Series; TM14-ADF715S; webpage retrieved on Mar. 28, 2018; pp. 1-2.

(56)

References Cited

OTHER PUBLICATIONS

- Tecmen Auto Darkening Welding Helmet; iWeld Series; TM14-ADF720S; webpage retrieved on Mar. 28, 2018; pp. 1-2.
- Tecmen Auto Darkening Welding Helmet; iWeld Series; TM14-ADF725S; webpage retrieved on Mar. 28, 2018; pp. 1-2.
- Tecmen Auto Darkening Welding Helmet; iWeld Series; TM14-ADF730S; webpage retrieved on Mar. 28, 2018; pp. 1-2.
- Tecmen Auto Darkening Welding Helmet; iMUX Series; TM14-ADF815S; webpage retrieved on Mar. 28, 2018; pp. 1-2.
- Tecmen Auto Darkening Welding Helmet; iMUX Series; TM14-ADF820S; webpage retrieved on Mar. 28, 2018; pp. 1-2.
- Tecmen Auto Darkening Welding Helmet; iMUX Series; TM14-ADF830S; webpage retrieved on Mar. 28, 2018; pp. 1-2.
- Tecmen Auto Darkening Welding Helmet; iEASY Series; TM17-ADF615J; webpage retrieved on Mar. 28, 2018; pp. 1-2.
- Tecmen Auto Darkening Welding Helmet; iEASY Series; TM17-ADF720S; webpage retrieved on Mar. 28, 2018; pp. 1-2.
- ITW Elite Lucky's Speed Shop—Auto Darkening Welding Helmet; Elite Series; Miller Electric Company; webpage retrieved Mar. 28, 2018; pp. 1-2.
- Viking 1740 Series; Auto Darkening Welding Helmets Brochure; Nov. 2017; pp. 1-2.
- Viking PAPR 3350 Welding helmet; Powered Air Purifying Respirator Brochure; Oct. 2017; pp. 1-8.
- Tecmen Auto Darkening Welding Helmet; iEASY Series; TM17-ADF725S; webpage retrieved on Mar. 28, 2018; pp. 1-2.

* cited by examiner

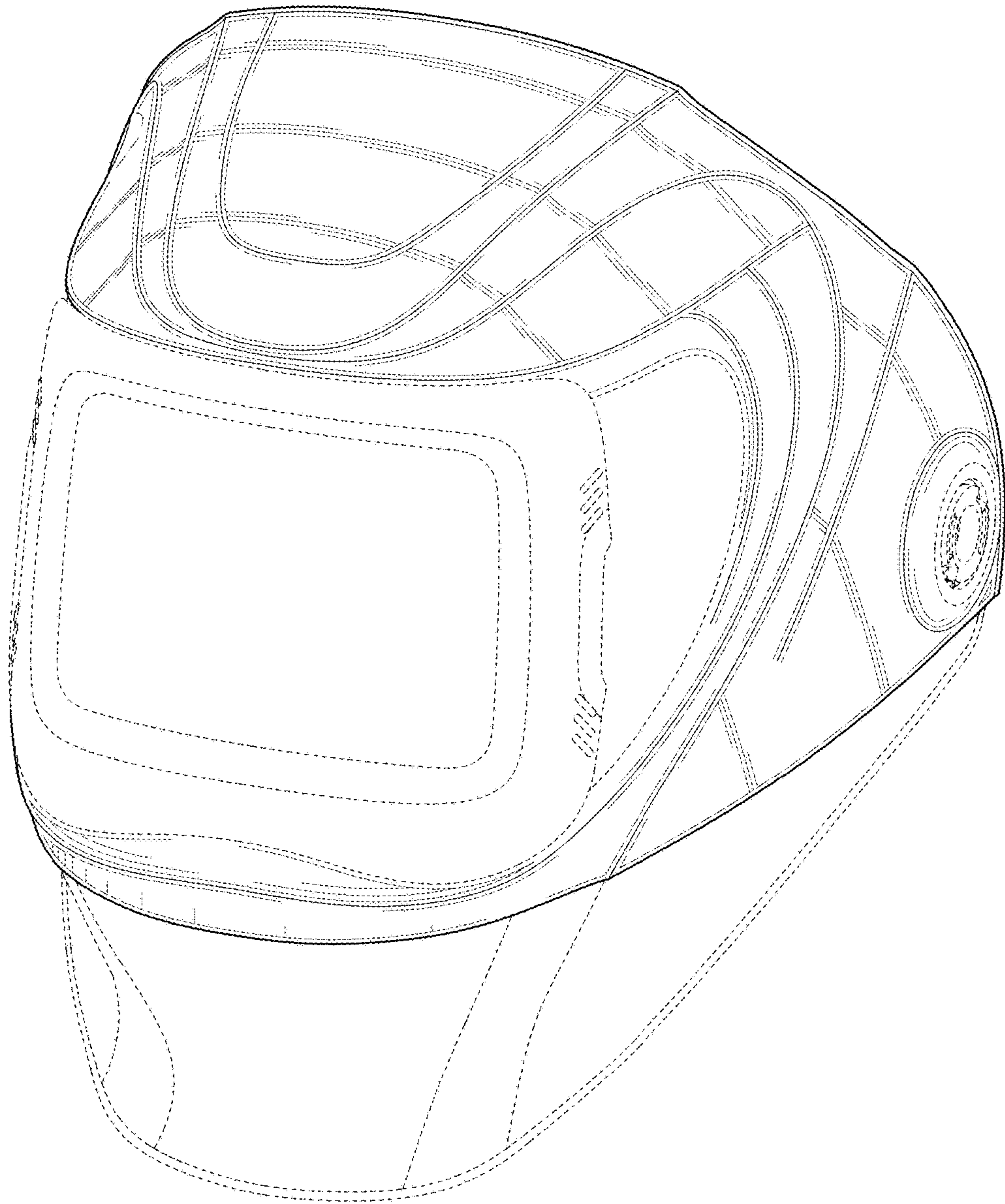

FIG. 1

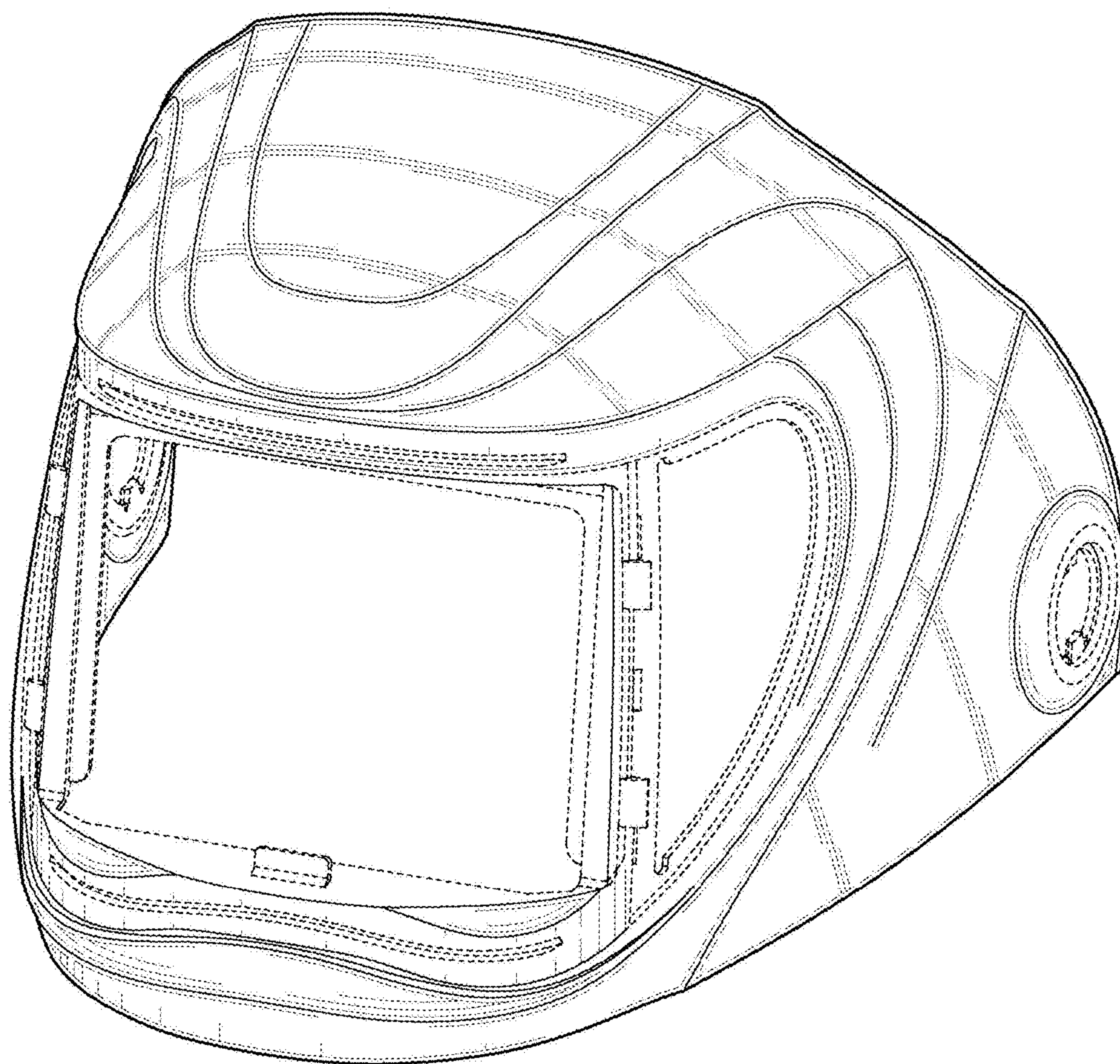

FIG. 2

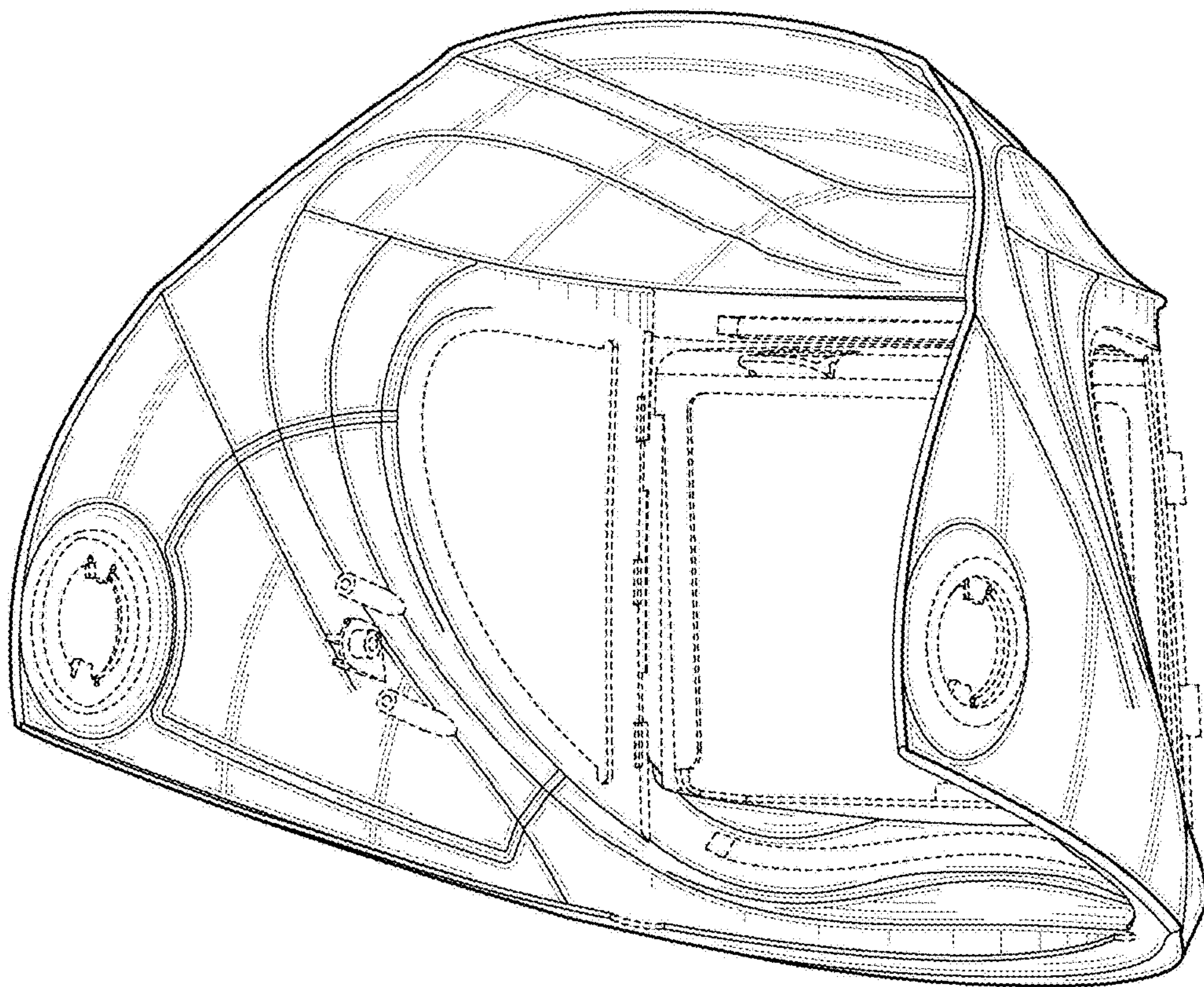

FIG. 3

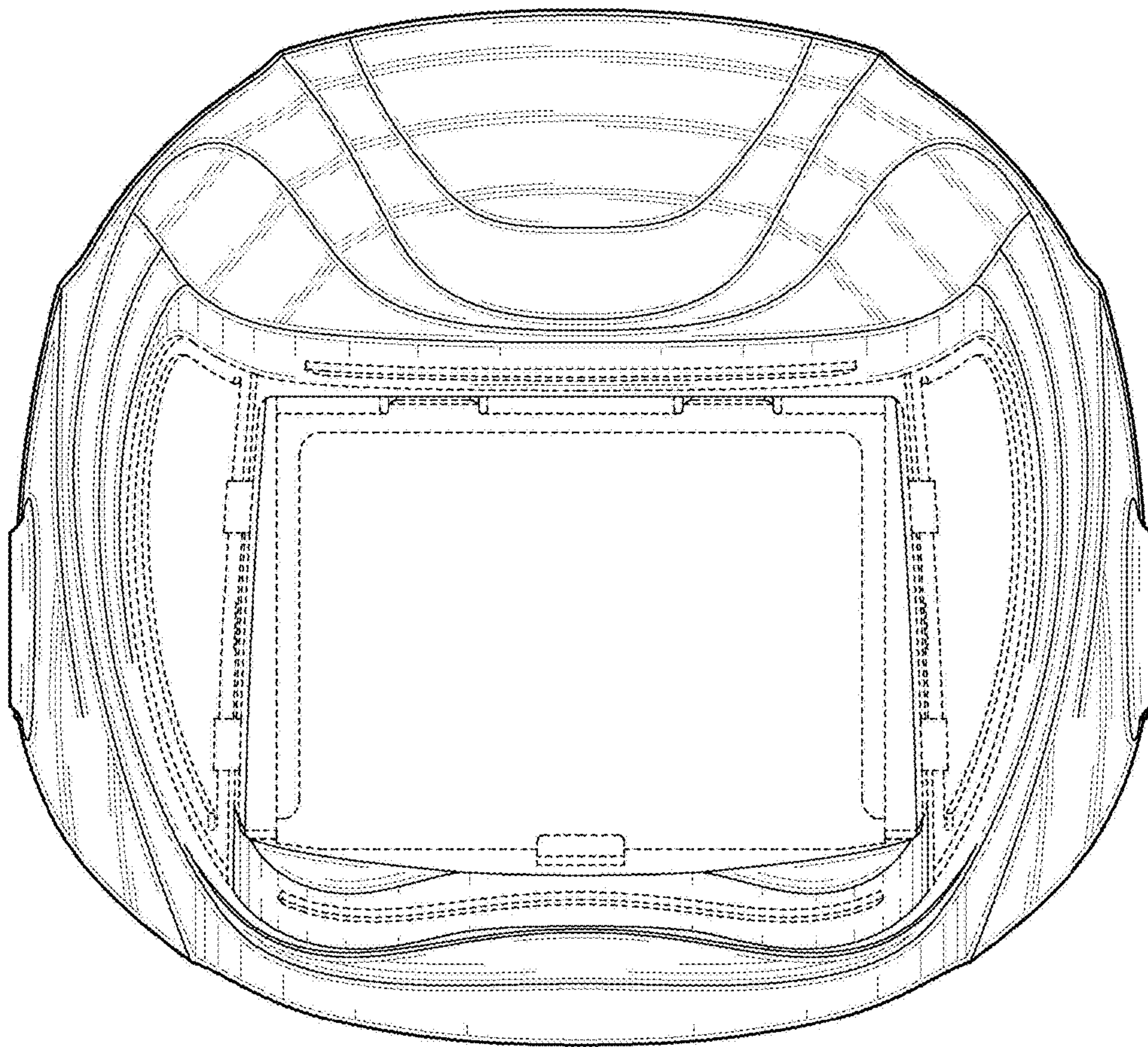

FIG. 4

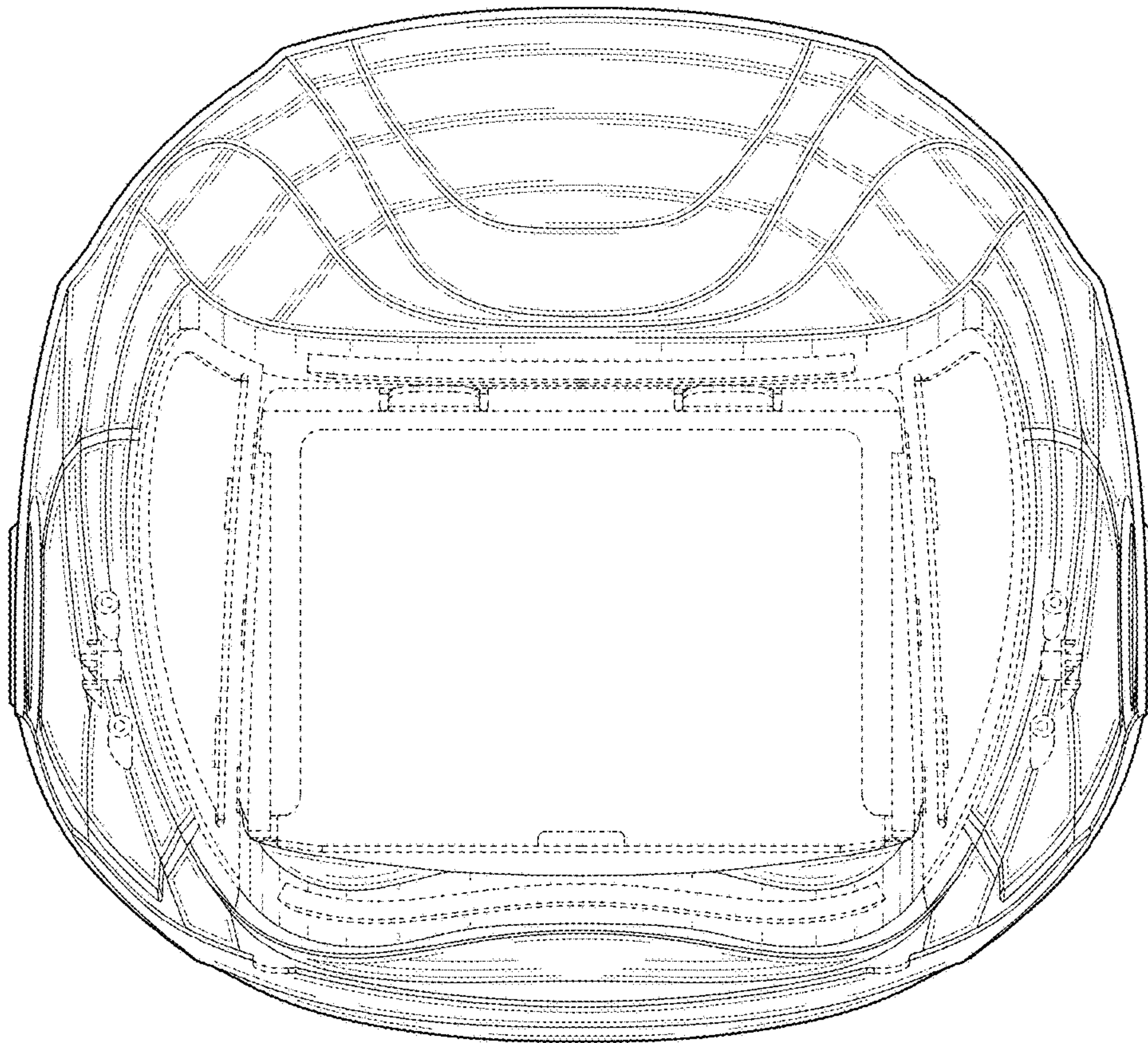

FIG. 5

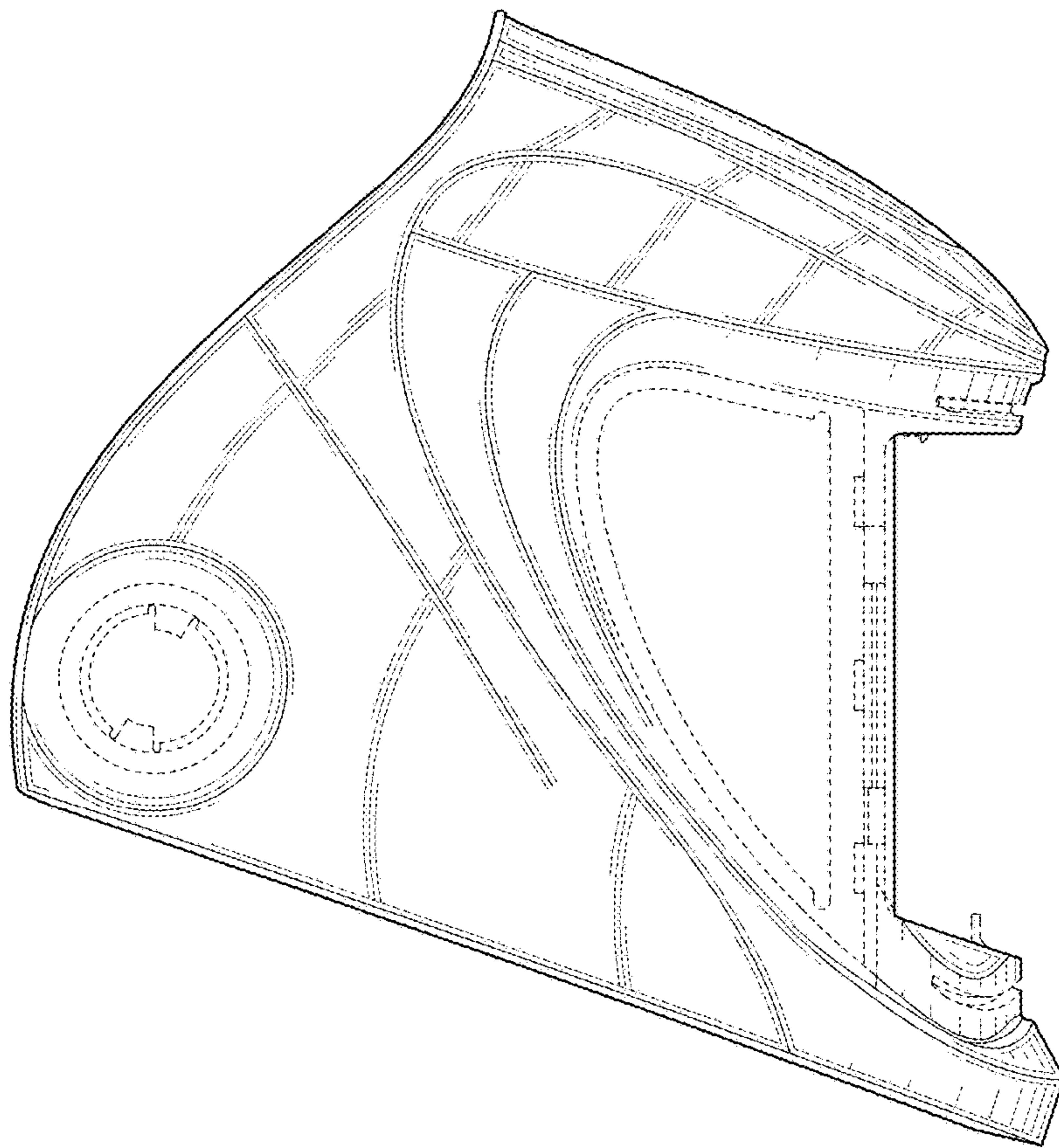

FIG. 6

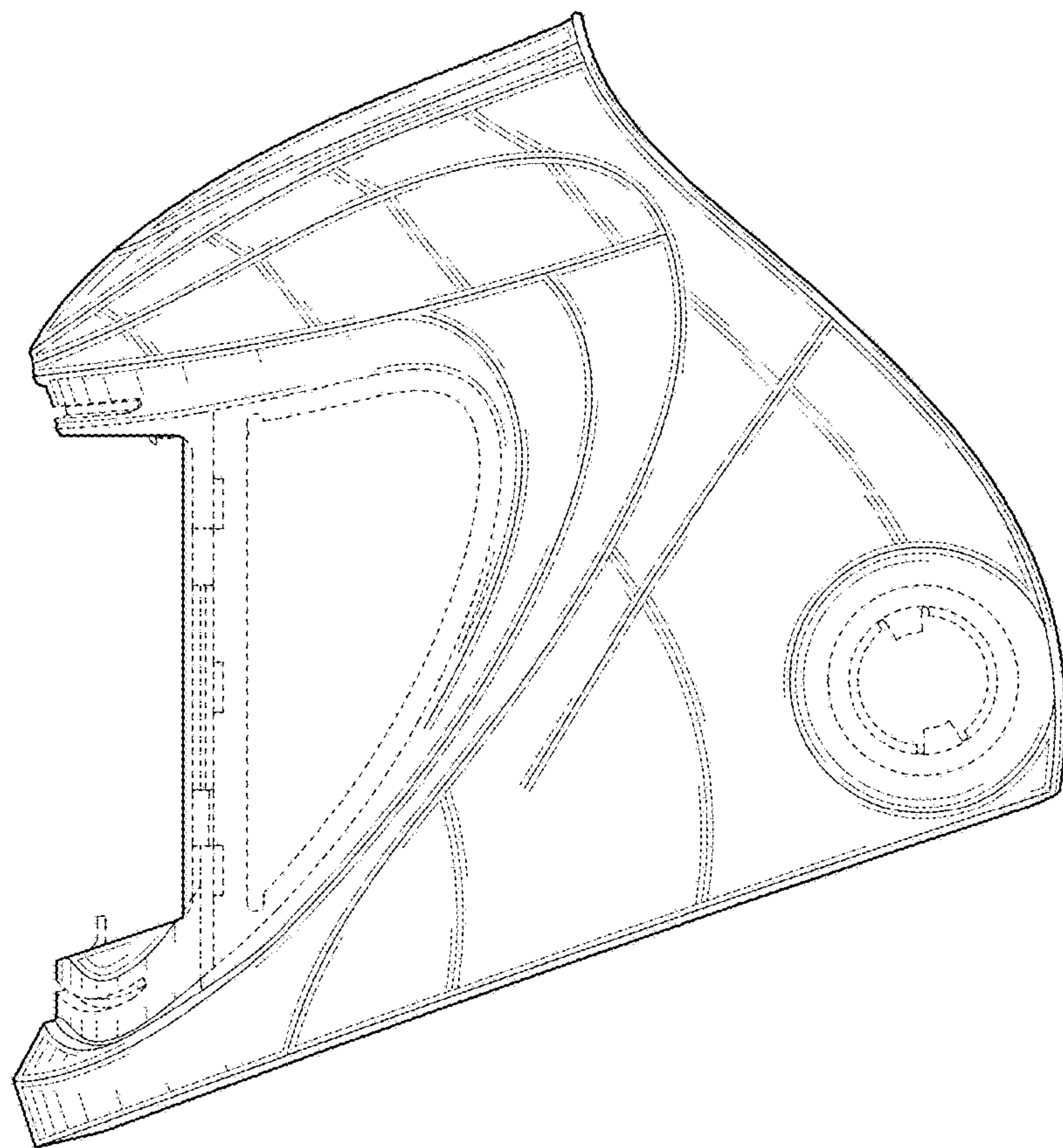

FIG. 7

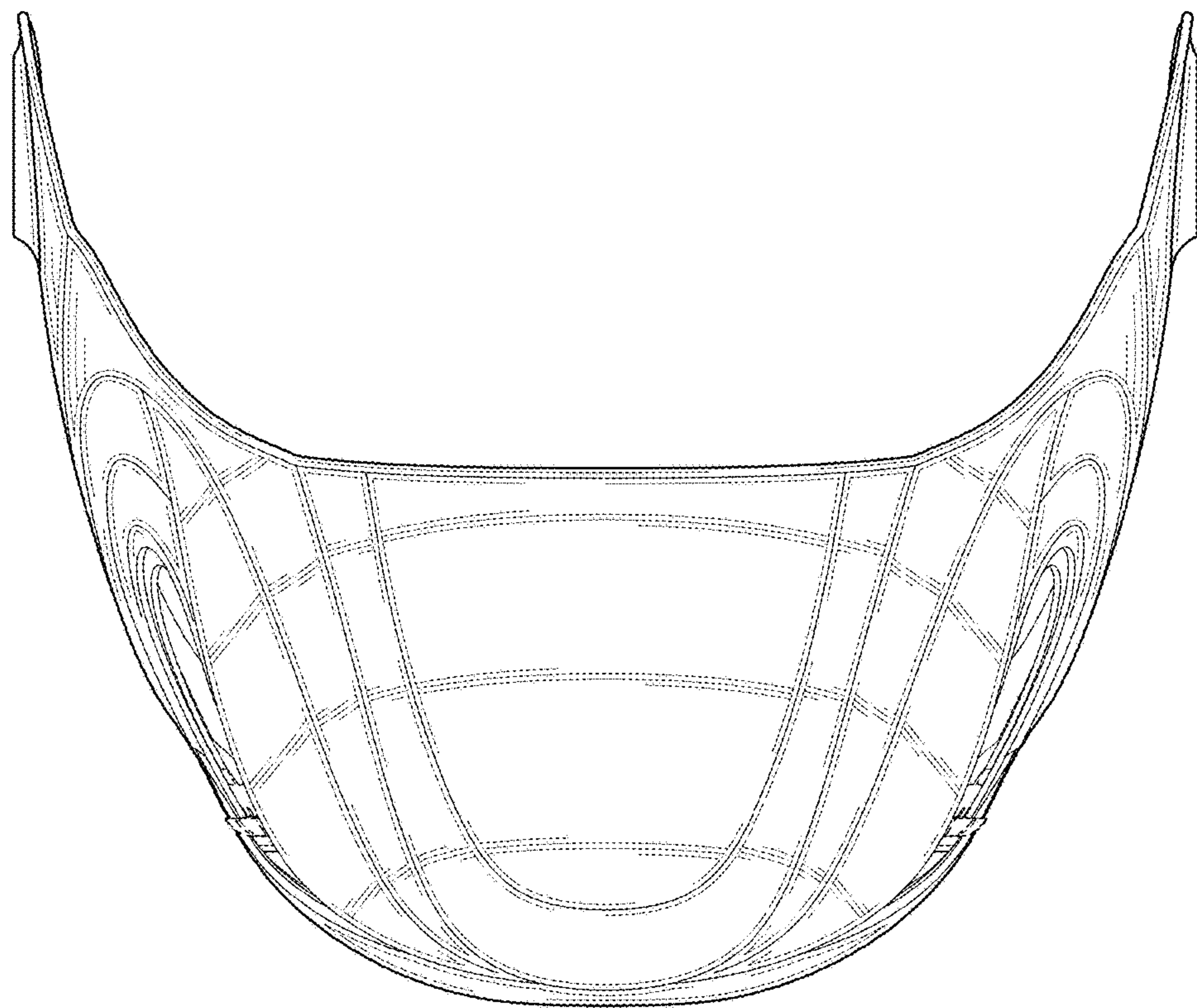

FIG. 8

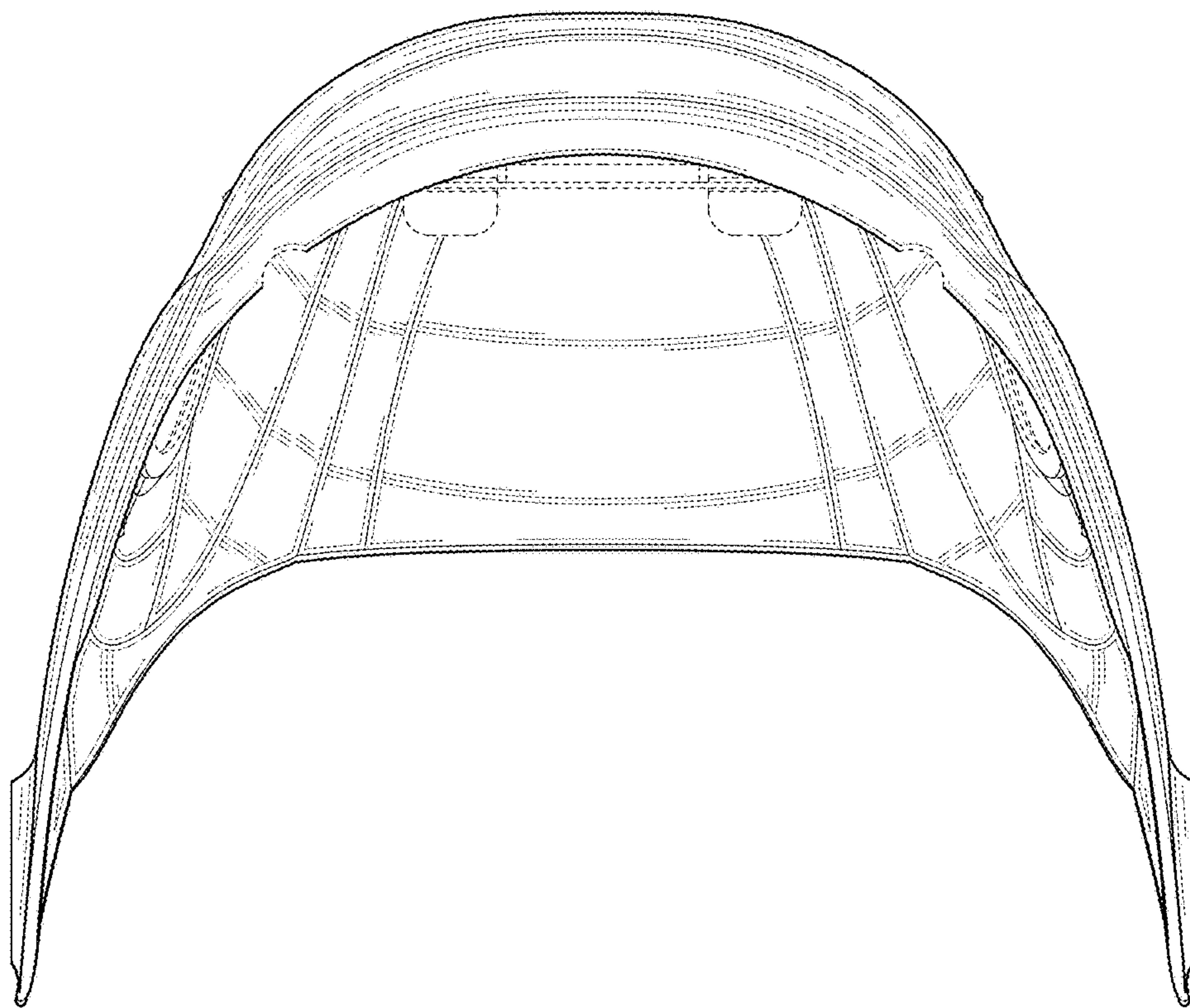

FIG. 9