



US00D860508S

(12) **United States Design Patent** (10) **Patent No.:** **US D860,508 S**
Coombes et al. (45) **Date of Patent:** **** Sep. 17, 2019**

- (54) **LAMP**
- (71) Applicant: **GIOPATO & COOMBES S.R.L.**,
Treviso (IT)
- (72) Inventors: **Christopher Coombes**, Treviso (IT);
Cristiana Giopato, Treviso (IT)
- (73) Assignee: **GIOPATO & COOMBES S.R.L.**,
Treviso (IT)
- (**) Term: **15 Years**
- (21) Appl. No.: **29/642,386**
- (22) Filed: **Mar. 29, 2018**
- (51) **LOC (12) Cl.** **26-03**
- (52) **U.S. Cl.**
USPC **D26/88**
- (58) **Field of Classification Search**
USPC D26/72, 80, 81, 82, 84, 85, 86, 88, 90,
D26/91, 118
CPC F21S 8/04; F21S 8/043; F21S 8/046; F21S
8/06; F21S 8/063; F21S 8/065; F21S
8/066; F21S 8/068
See application file for complete search history.

(56) **References Cited**

U.S. PATENT DOCUMENTS

- D24,737 S * 10/1895 Ferguson D26/81
D38,638 S * 6/1907 Weyer D26/88
D76,194 S * 8/1928 Knorr D26/84
D90,017 S * 5/1933 Bush D26/84
D162,278 S * 3/1951 Ainsworth D26/78
D220,206 S * 3/1971 Hamburger D26/75
D304,768 S * 11/1989 Dicola D26/84
D342,338 S * 12/1993 Thun D26/88
D436,210 S * 1/2001 Miranda D26/81
D697,251 S * 1/2014 Baylar F21S 8/06
D26/88
D705,475 S * 5/2014 Kitts D26/81

- D713,090 S * 9/2014 Kim D26/90
D728,141 S * 4/2015 Nicholas D26/81
D728,145 S * 4/2015 Shiqiang D26/88
(Continued)

OTHER PUBLICATIONS

CIRQUE Pendant Light. From archetypal.hk visited Apr. 11, 2019.
(Year: 2019).*

Primary Examiner — Clare E Heflin

(74) *Attorney, Agent, or Firm* — Cantor Colburn LLP

(57) **CLAIM**

We claim, the ornamental design for a lamp, as shown and described.

DESCRIPTION

FIG. 1 is a perspective view of a lamp, showing my new design;
FIG. 2 is a front elevation view thereof;
FIG. 3 is a rear elevation view thereof;
FIG. 4 is a left side elevation view thereof;
FIG. 5 is a right side elevation view thereof;
FIG. 6 is a top plan view thereof;
FIG. 7 is a bottom plan view thereof;
FIG. 8 is a perspective view of another embodiment thereof;
FIG. 9 is a front elevation view thereof;
FIG. 10 is a rear elevation view thereof;
FIG. 11 is a left side elevation view thereof;
FIG. 12 is a right side elevation view thereof;
FIG. 13 is a top plan view thereof;
FIG. 14 is a bottom plan view thereof;
FIG. 15 is a perspective view of another embodiment thereof;
FIG. 16 is a front elevation view thereof;
FIG. 17 is a rear elevation view thereof;
FIG. 18 is a left side elevation view thereof;
FIG. 19 is a right side elevation view thereof;
FIG. 20 is a top plan view thereof; and,
FIG. 21 is a bottom plan view thereof.

1 Claim, 15 Drawing Sheets

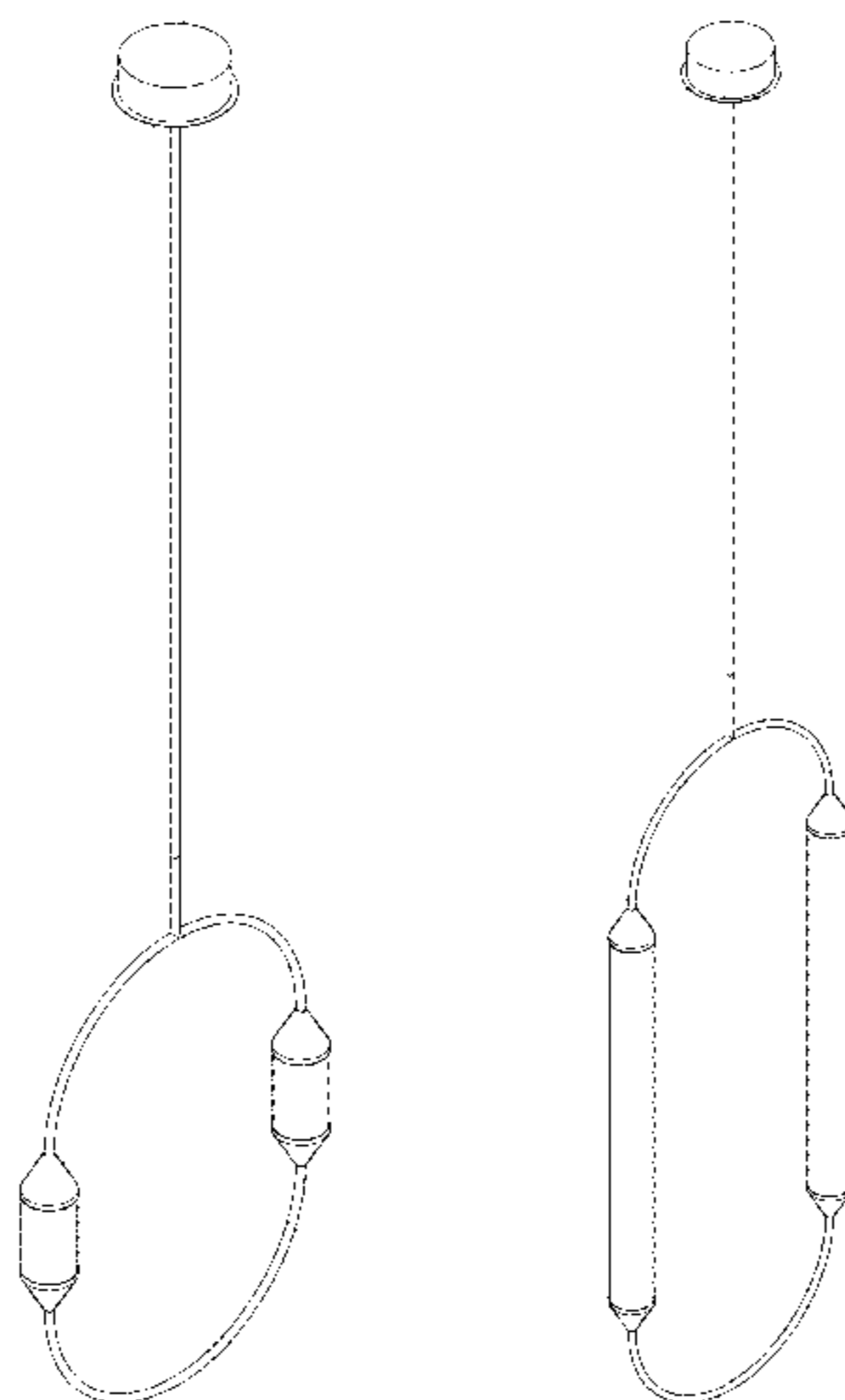

(56)

References Cited

U.S. PATENT DOCUMENTS

D779,102	S	*	2/2017	Garraton	D26/81
D805,238	S	*	12/2017	Amato	D26/88
D827,187	S	*	8/2018	Silver	D26/90
D827,908	S	*	9/2018	Silver	D26/90
2006/0098444	A1	*	5/2006	Petruzzi	F21S 8/06
						362/404
2012/0241579	A1	*	9/2012	Karlsson	F21V 21/096
						248/343

* cited by examiner

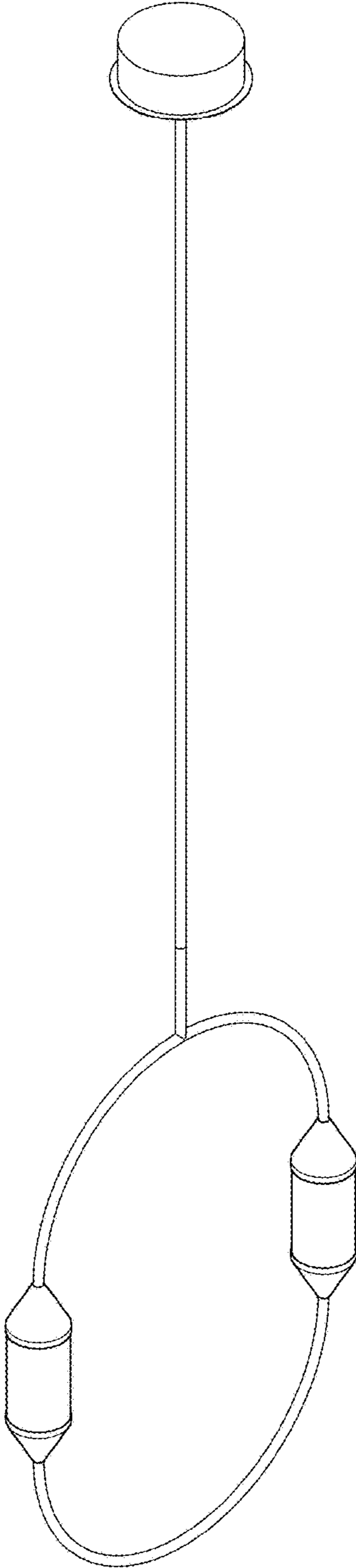

Fig. 1

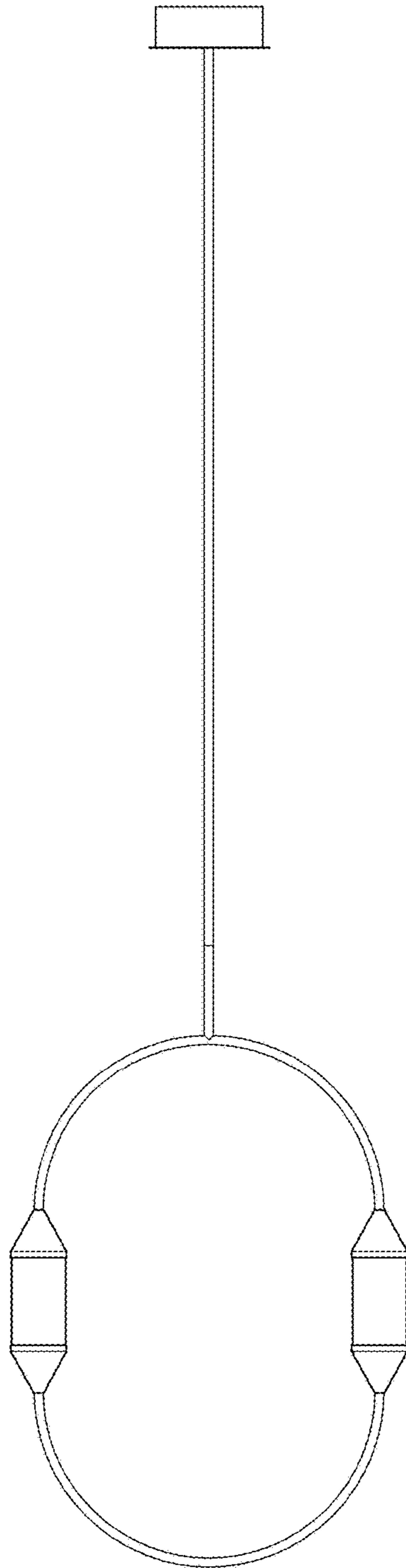

Fig. 2

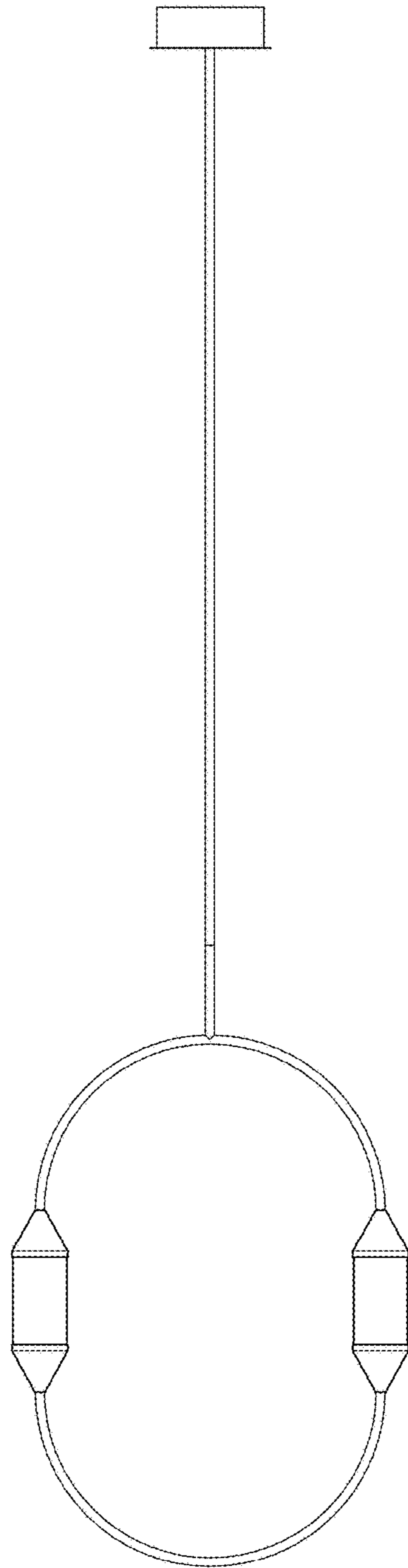

Fig. 3

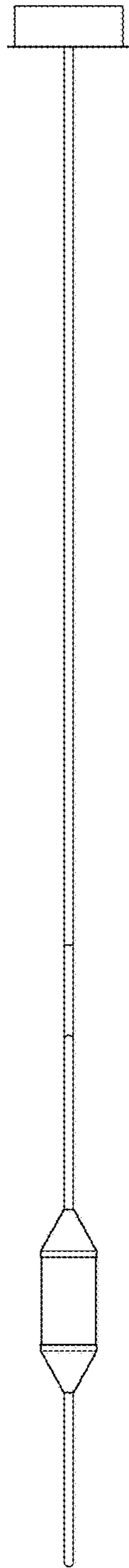

Fig. 4

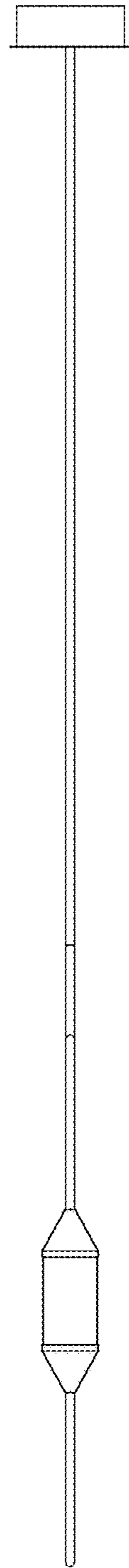

Fig. 5

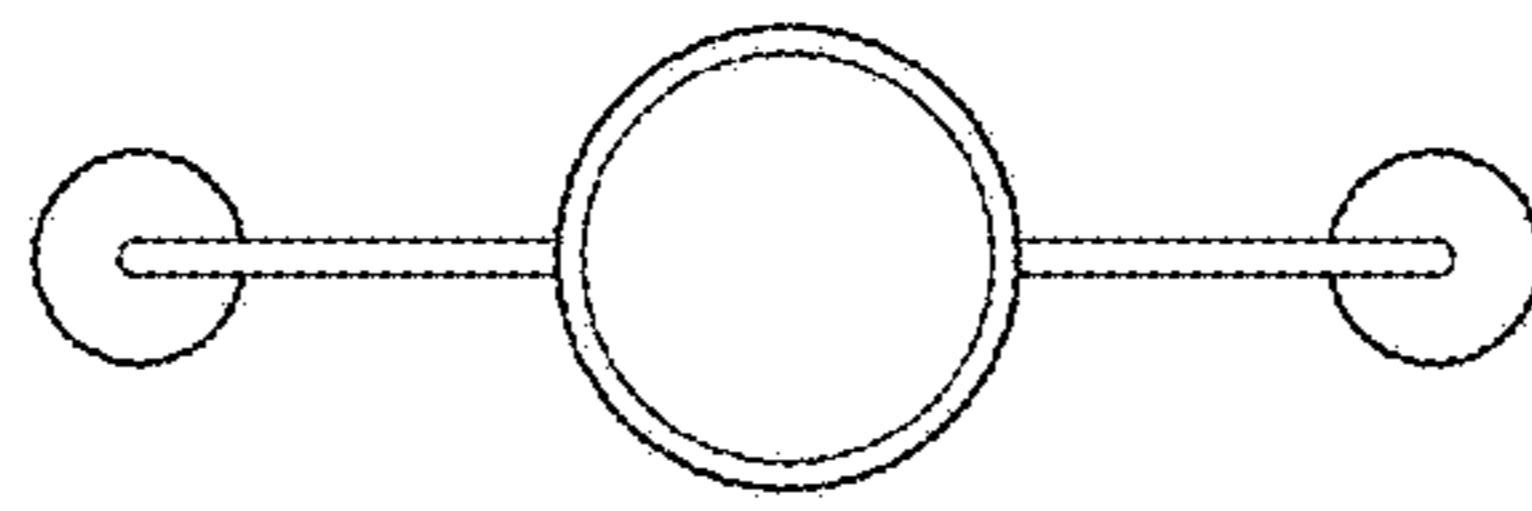

Fig. 6

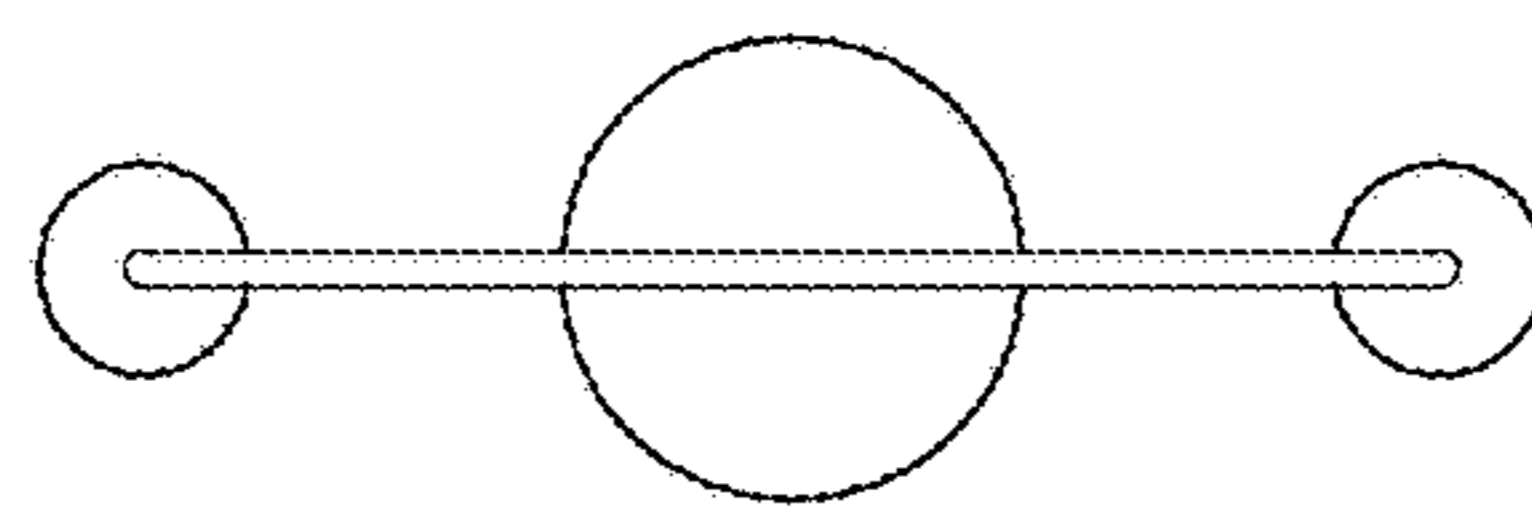

Fig. 7

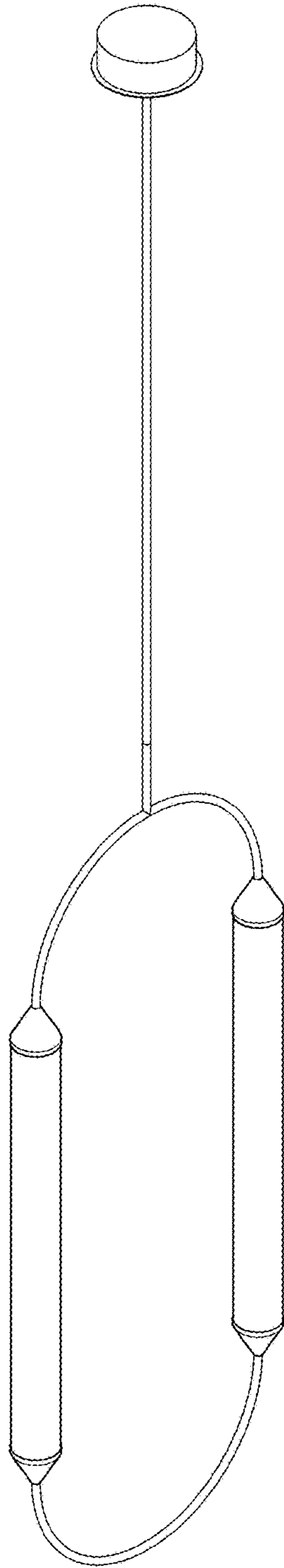

Fig. 8

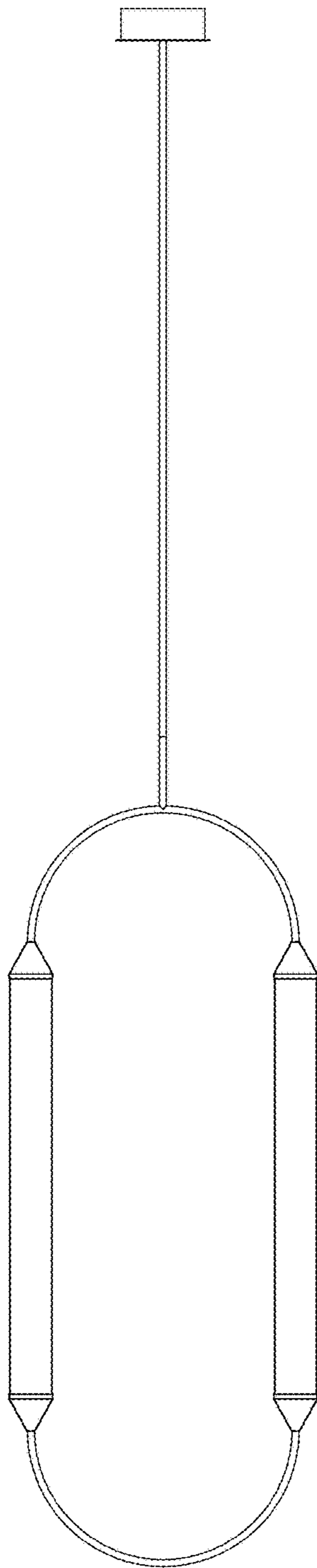

Fig. 9

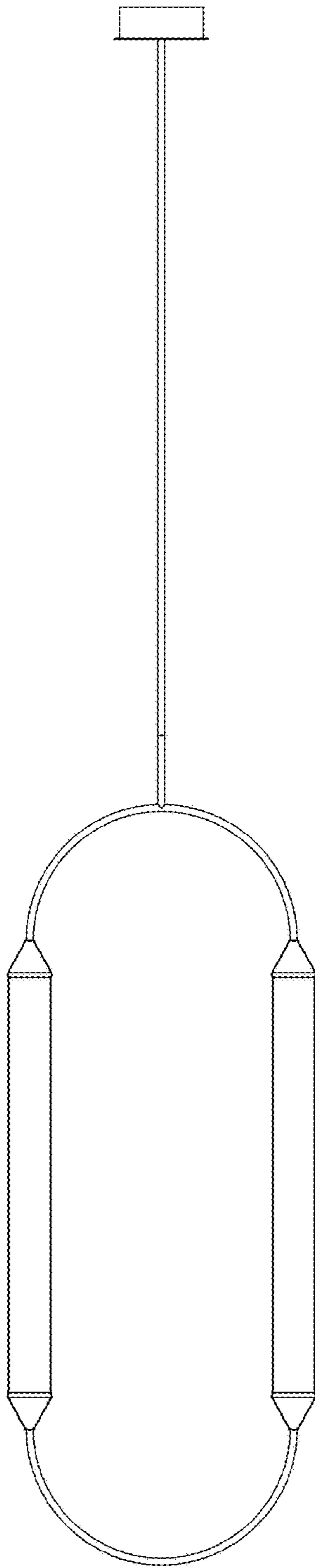

Fig. 10

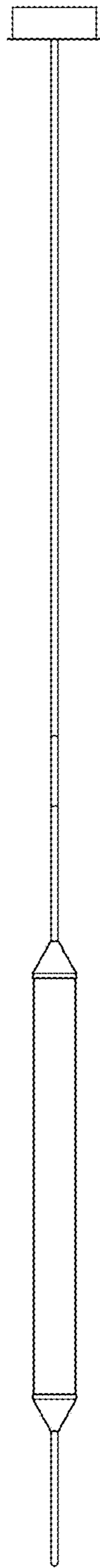

Fig. 11

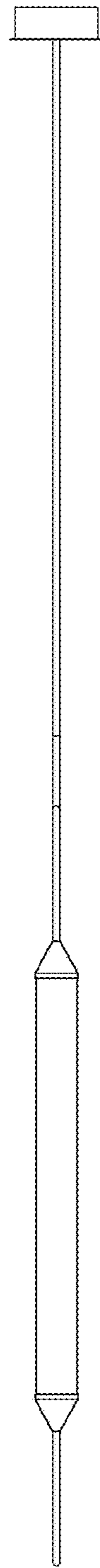

Fig. 12

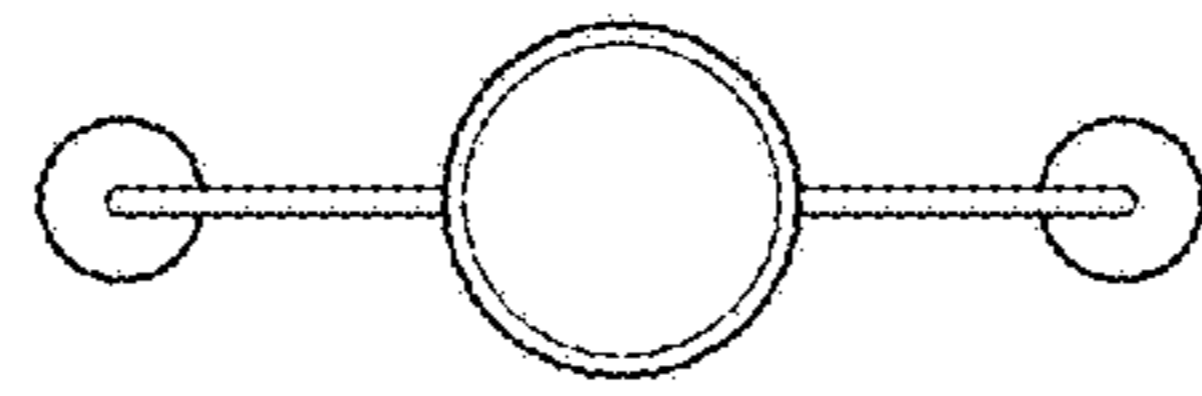

Fig. 13

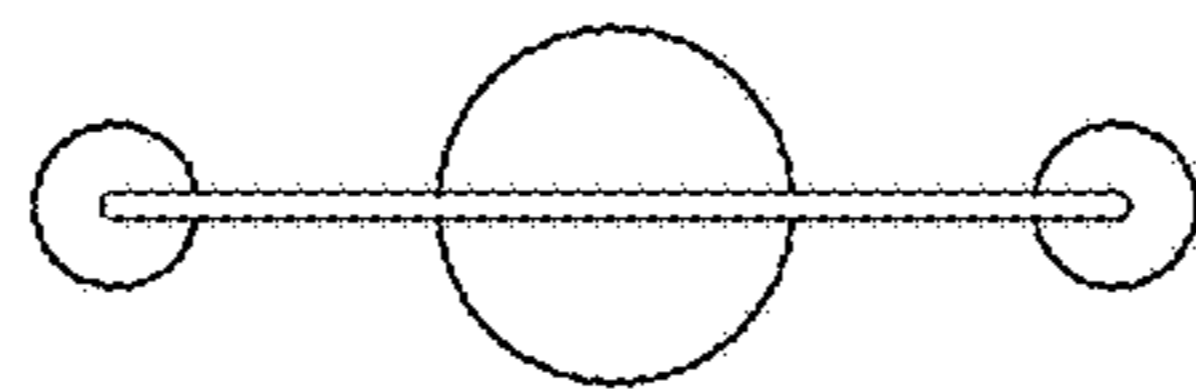

Fig. 14

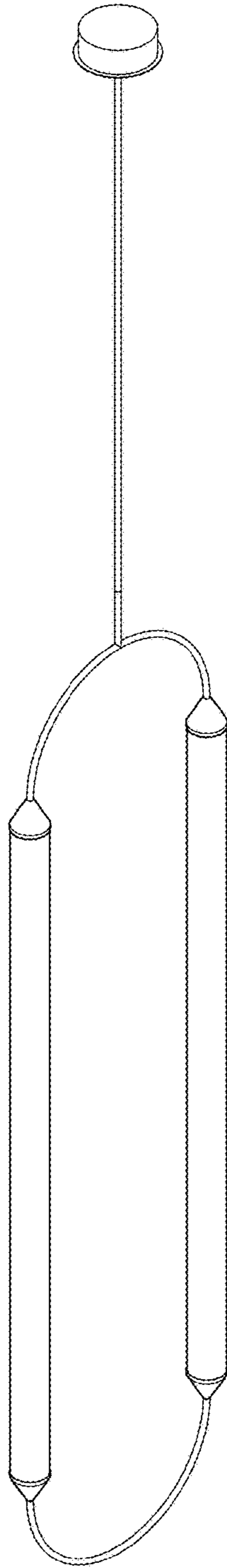

Fig. 15

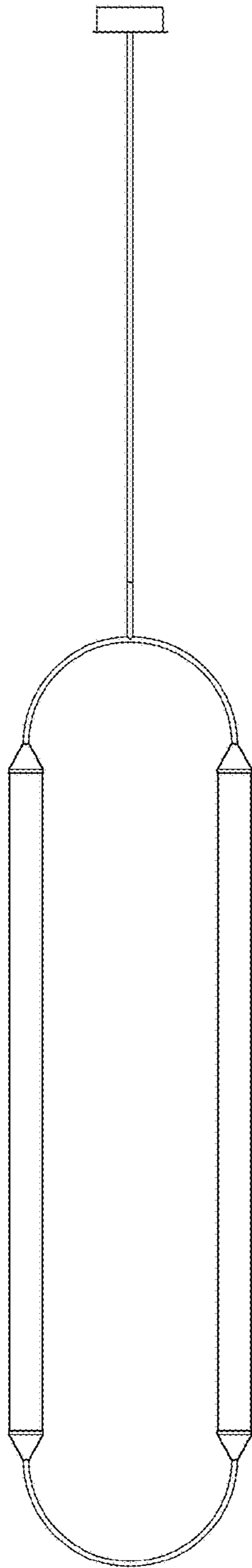

Fig. 16

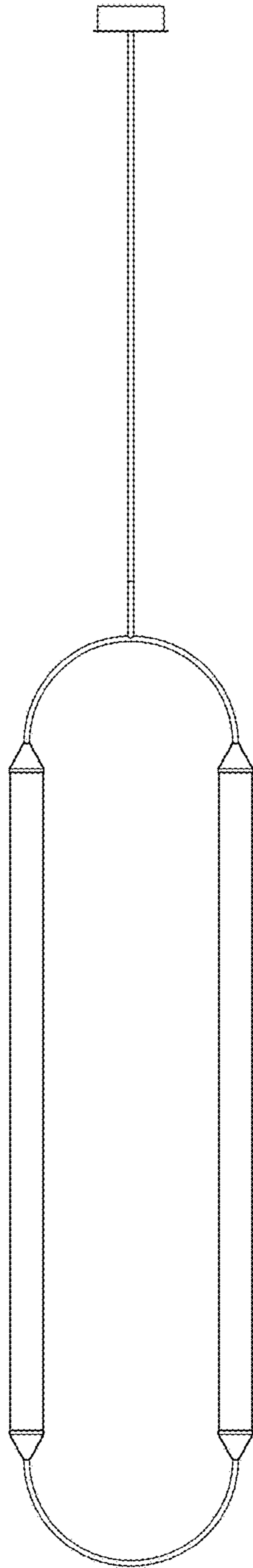

Fig. 17

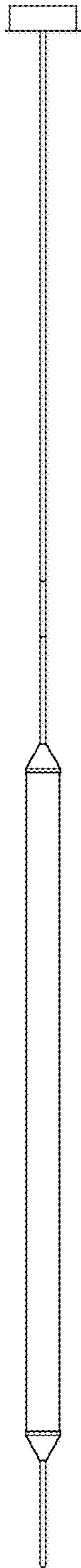

Fig. 18

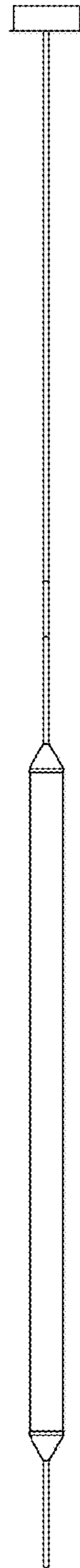

Fig. 19

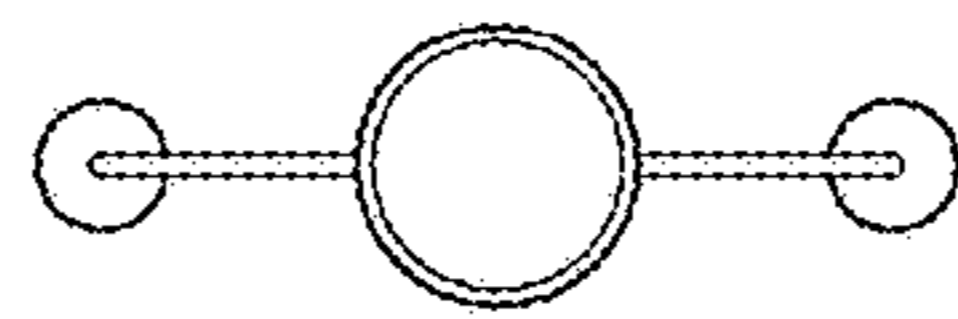

Fig. 20

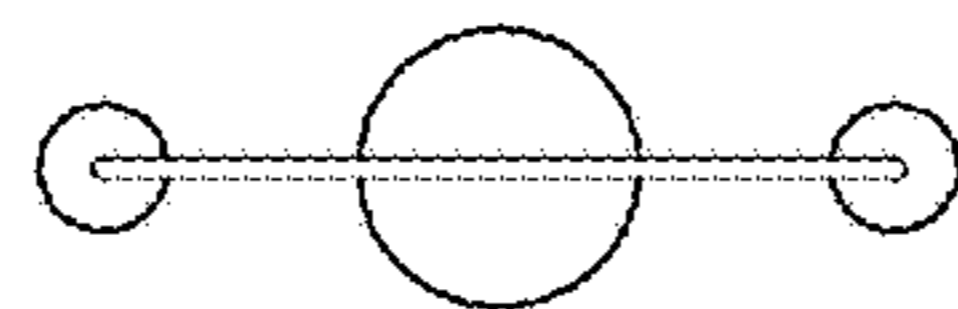

Fig. 21