



US00D860460S

(12) **United States Design Patent**  
**Sinha et al.**

(10) **Patent No.:** **US D860,460 S**

(45) **Date of Patent:** **\*\* Sep. 17, 2019**

(54) **CONTAINER FOR A FORCED AIR WARMING MACHINE**

(71) Applicant: **Care Essentials Pty Ltd**, Victoria (AU)

(72) Inventors: **Abhay Sinha**, Victoria (AU); **Ishan Sinha**, Victoria (AU)

(73) Assignee: **Care Essentials Pty Ltd**, North Geelong (AU)

(\*\*) Term: **15 Years**

(21) Appl. No.: **29/622,480**

(22) Filed: **Oct. 17, 2017**

(30) **Foreign Application Priority Data**

May 2, 2017 (AU) ..... 201712589

(51) **LOC (12) Cl.** ..... **24-02**

(52) **U.S. Cl.**  
USPC ..... **D24/164; D9/430**

(58) **Field of Classification Search**  
USPC ... D24/164, 165, 186, 185, 231, 234, 110.5,  
D24/110.6; D9/432, 433, 423, 430, 439,  
D9/418, 428  
CPC ..... A61F 7/007; A61F 2007/0088; A61F  
2007/0089

See application file for complete search history.

(56) **References Cited**

**U.S. PATENT DOCUMENTS**

2,173,494 A \* 9/1939 Rous ..... B65D 71/36  
206/168  
D349,458 S \* 8/1994 Verdaguer ..... D9/415  
5,950,831 A \* 9/1999 Millet ..... B65D 5/2038  
206/446  
D456,710 S \* 5/2002 Persson ..... D9/431  
D622,139 S \* 8/2010 Marcott ..... D9/418  
D652,934 S \* 1/2012 Dougherty, IV ..... D24/163

8,505,807 B2 \* 8/2013 Herman ..... B65D 1/265  
229/128  
D716,646 S \* 11/2014 Ng ..... D9/415  
D738,717 S \* 9/2015 Lujardo ..... D9/418

(Continued)

**FOREIGN PATENT DOCUMENTS**

CN 3317636 \* 8/2003  
WO WO-2010102086 A2 \* 9/2010 ..... A61F 7/0053

**OTHER PUBLICATIONS**

Creative Bag. Link: <https://www.creativebag.com/ca/boxes/bakery-boxes-take-away>. Visited Feb. 5, 2019. Bakery Boxes—Take Away. (Year: 2019).\*

*Primary Examiner* — Susan Bennett Hattan

*Assistant Examiner* — Lauren D McVey

(74) *Attorney, Agent, or Firm* — Rahman LLC

(57) **CLAIM**

The ornamental design for a container for a forced air warming machine, as shown and described.

**DESCRIPTION**

FIG. 1 is a front perspective view of a container for a forced air warming machine showing the claimed design.

FIG. 2 is a rear perspective view of a container for a forced air warming machine showing the claimed design.

FIG. 3 is a front view of a container for a forced air warming machine showing the claimed design.

FIG. 4 is a rear view of a container for a forced air warming machine showing the claimed design.

FIG. 5 is a top view of a container for a forced air warming machine showing the claimed design.

FIG. 6 is a bottom view of a container for a forced air warming machine showing the claimed design.

FIG. 7 is a left-side view of a container for a forced air warming machine showing the claimed design; and,

FIG. 8 is a right-side view of a container for a forced air warming machine showing the claimed design.

**1 Claim, 8 Drawing Sheets**

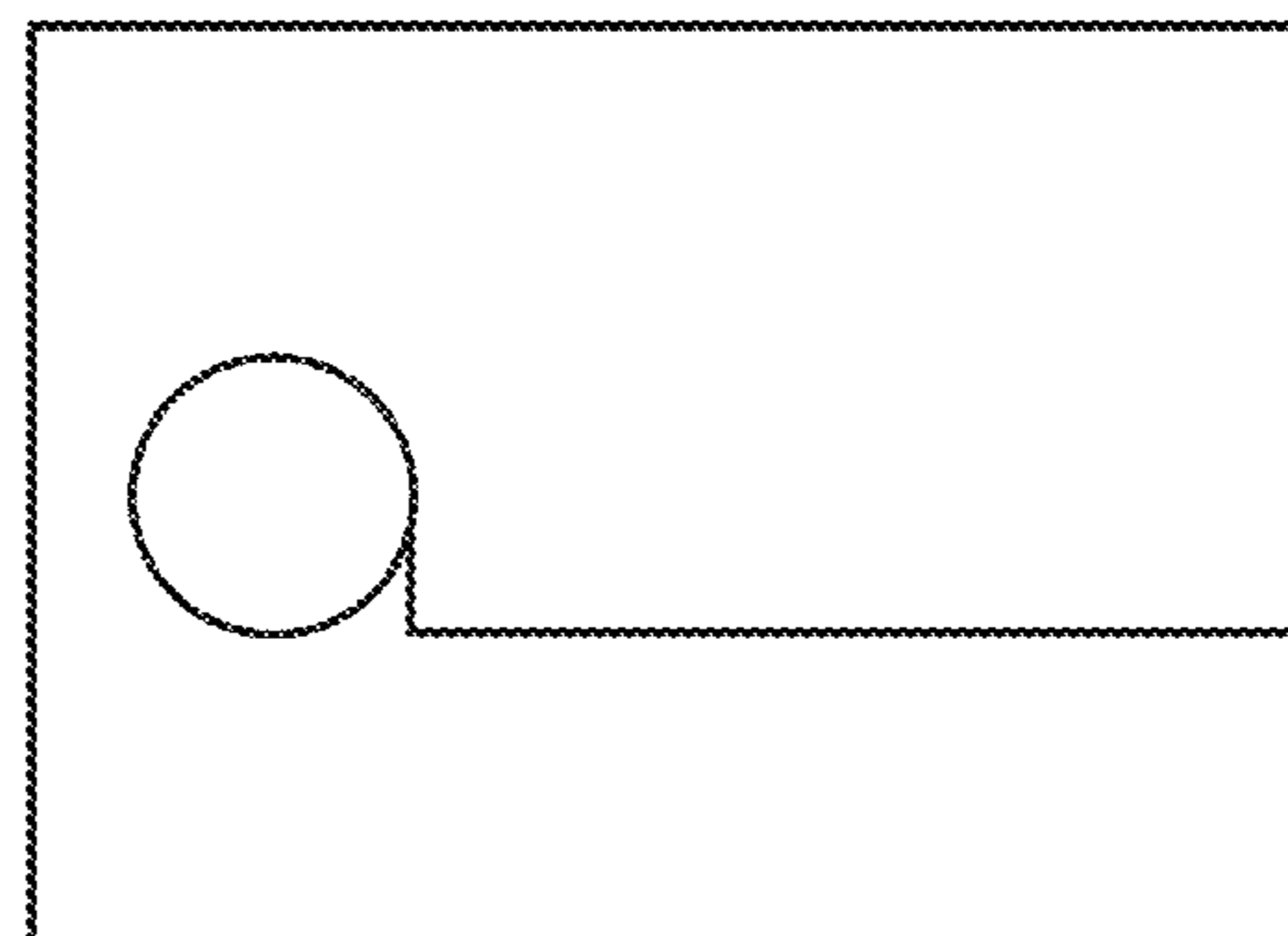
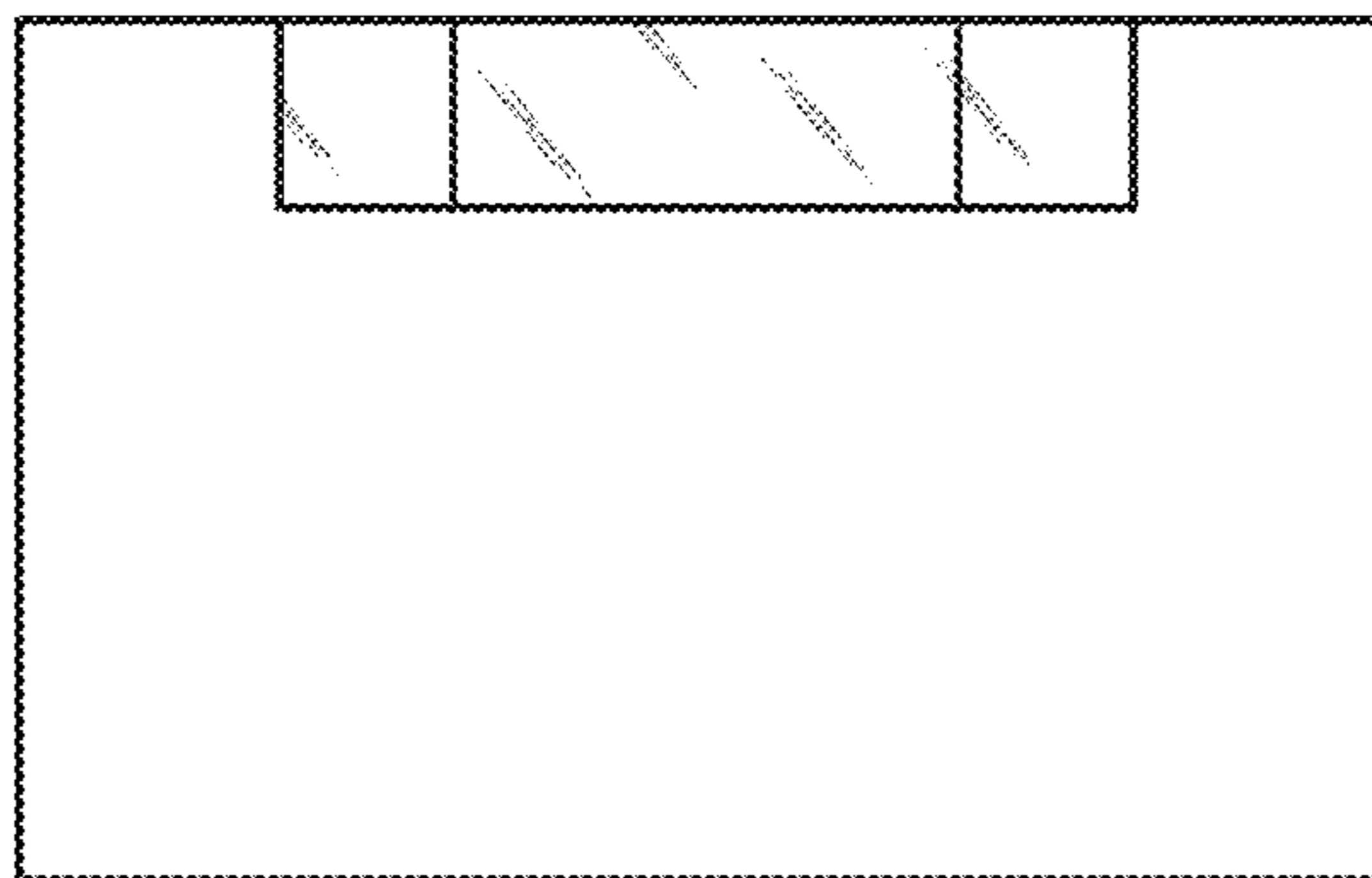

(56)

**References Cited**

U.S. PATENT DOCUMENTS

D739,026 S *	9/2015	Anger .....	D24/164
D765,500 S *	9/2016	Brown .....	D9/415
D778,151 S *	2/2017	Watson .....	D9/418
D795,687 S *	8/2017	Pollock .....	D9/418

\* cited by examiner

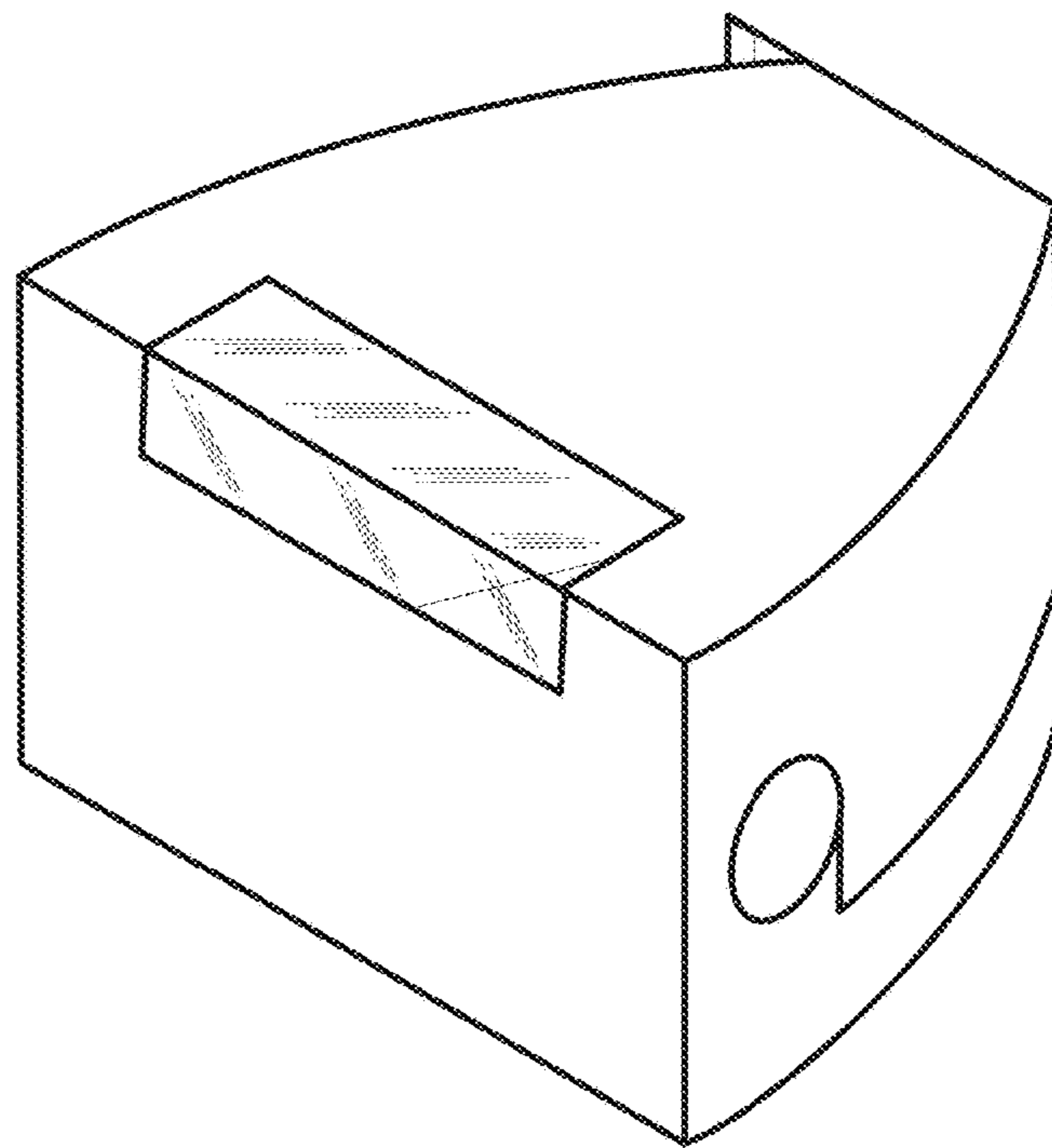

FIG. 1

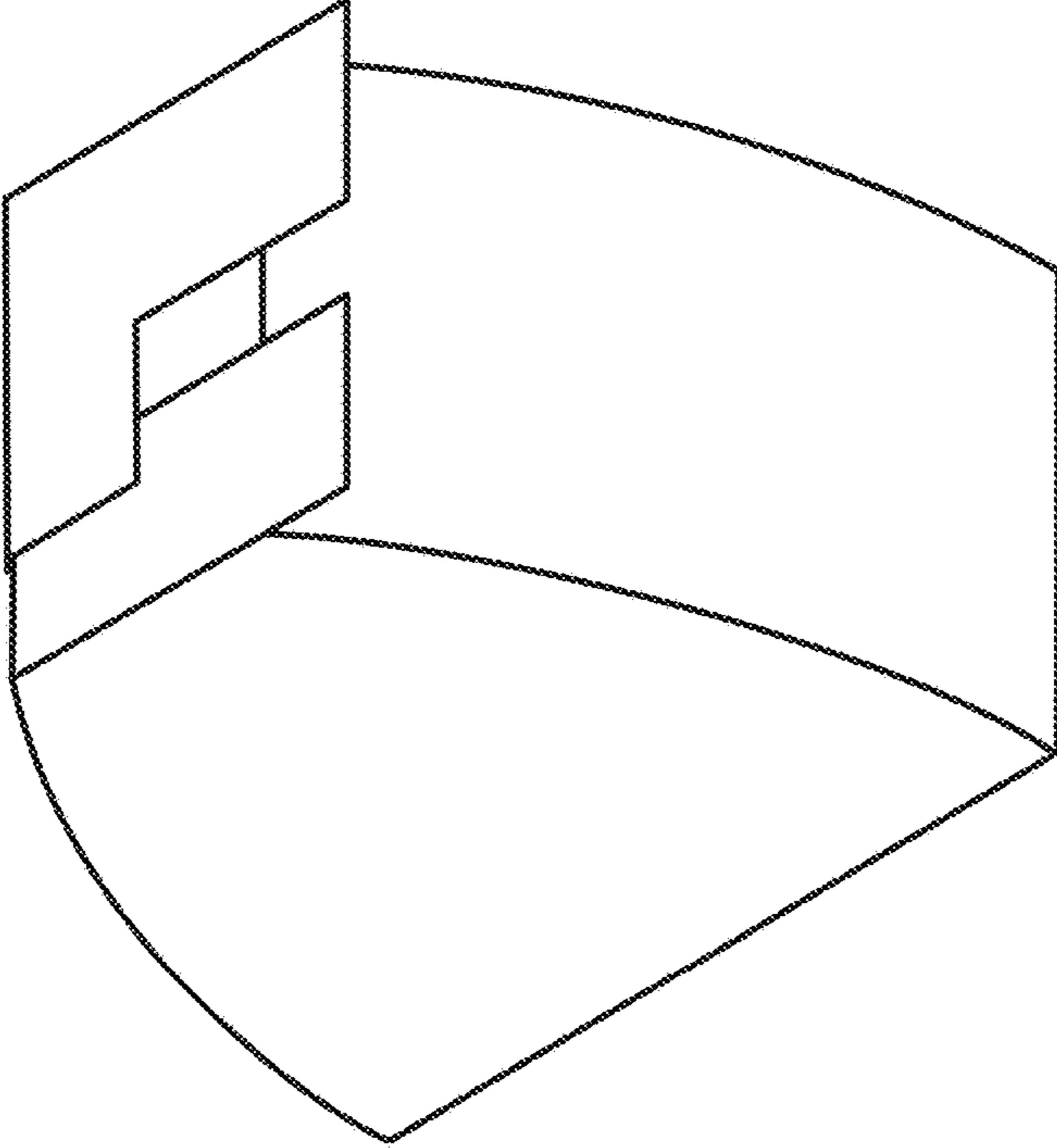

FIG. 2

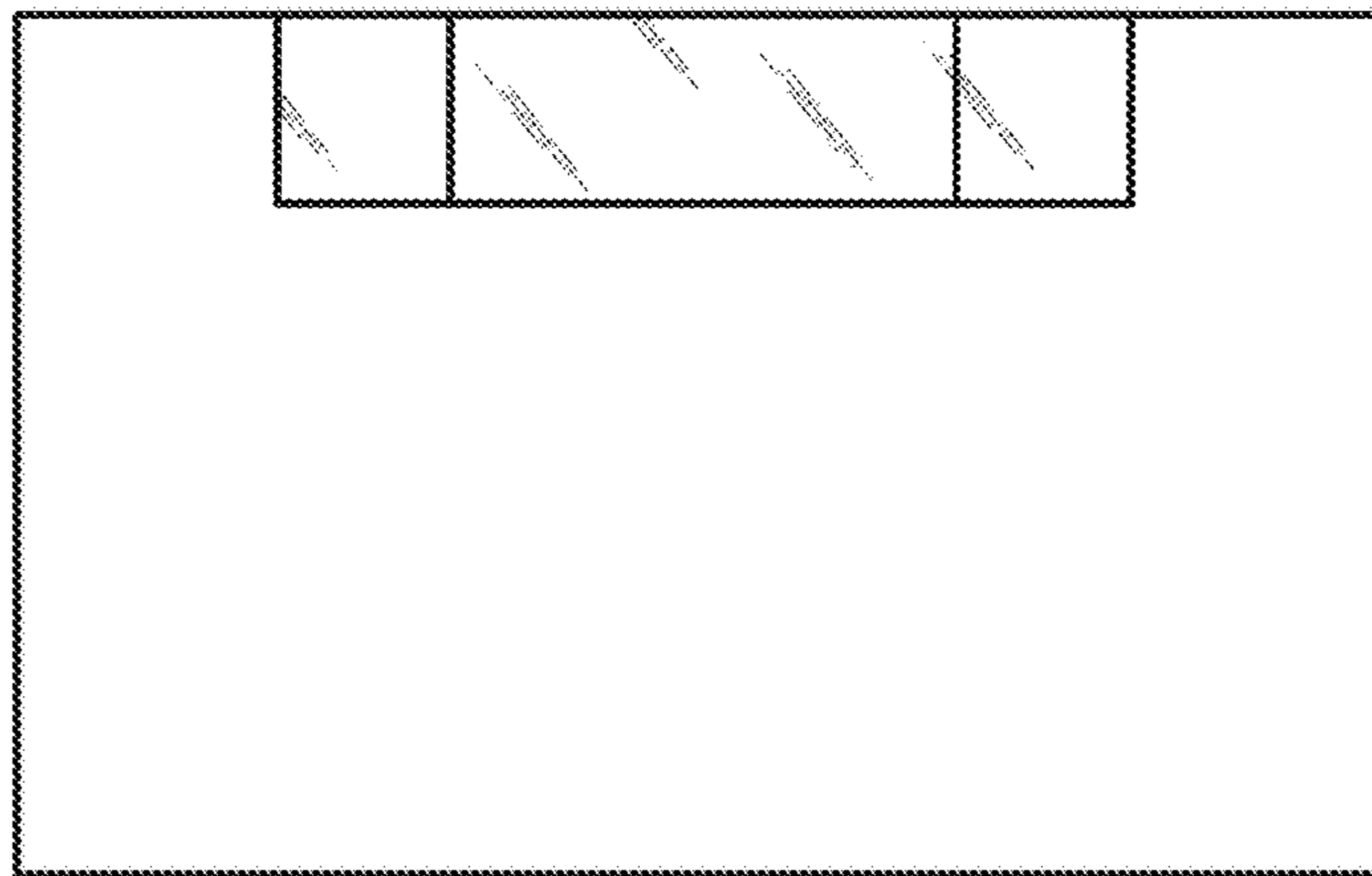

FIG. 3

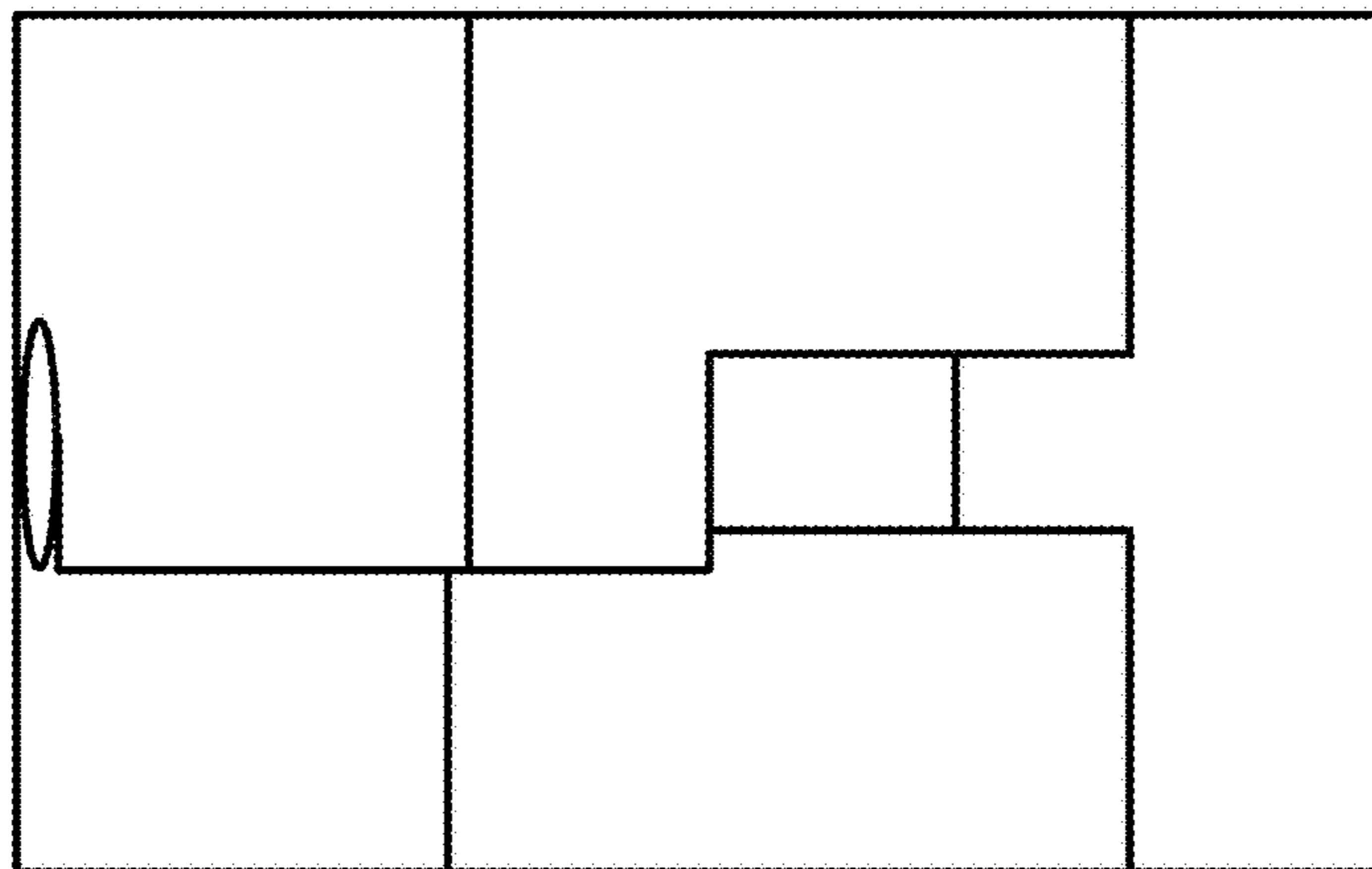

FIG. 4

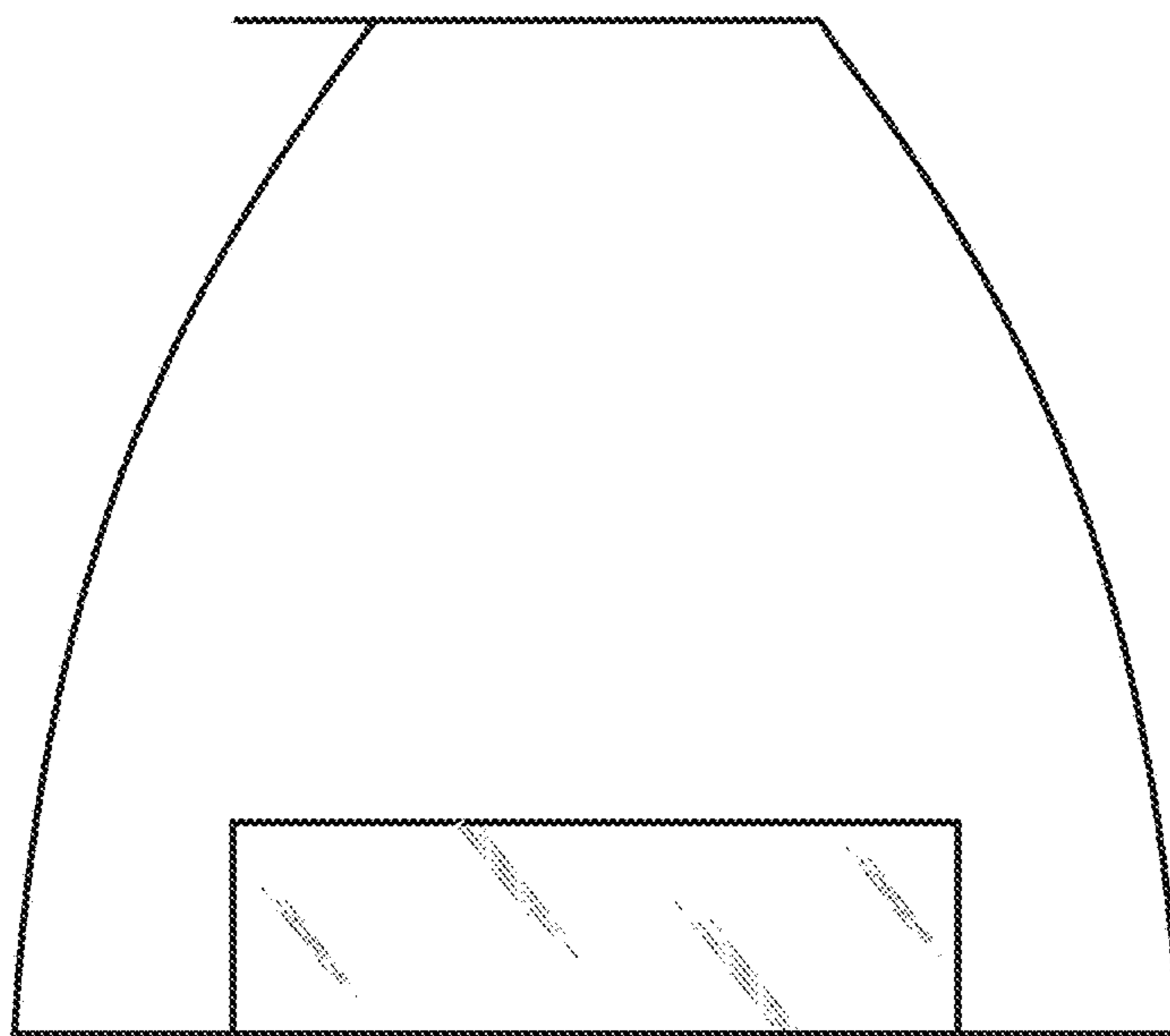

FIG. 5

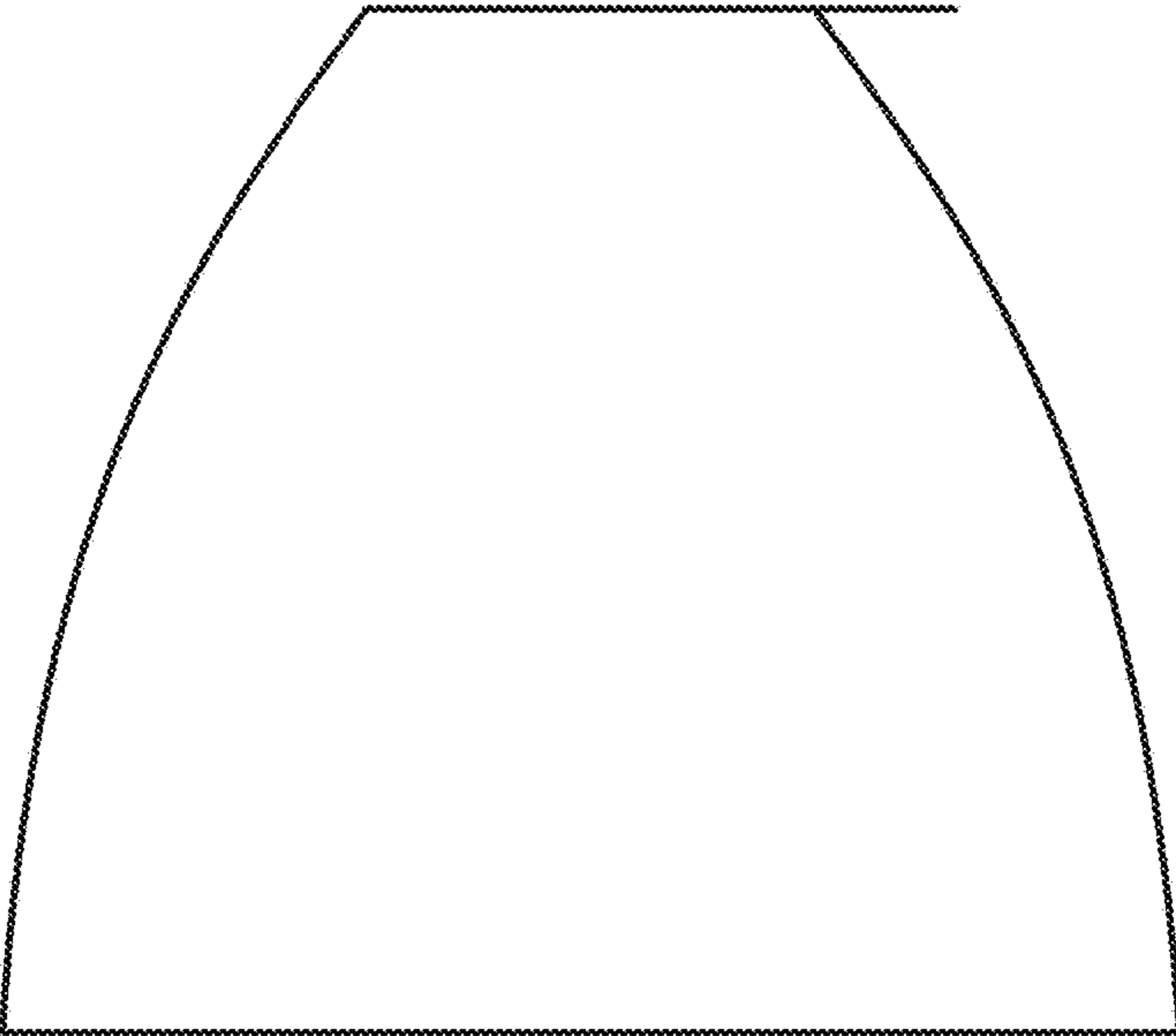

FIG. 6



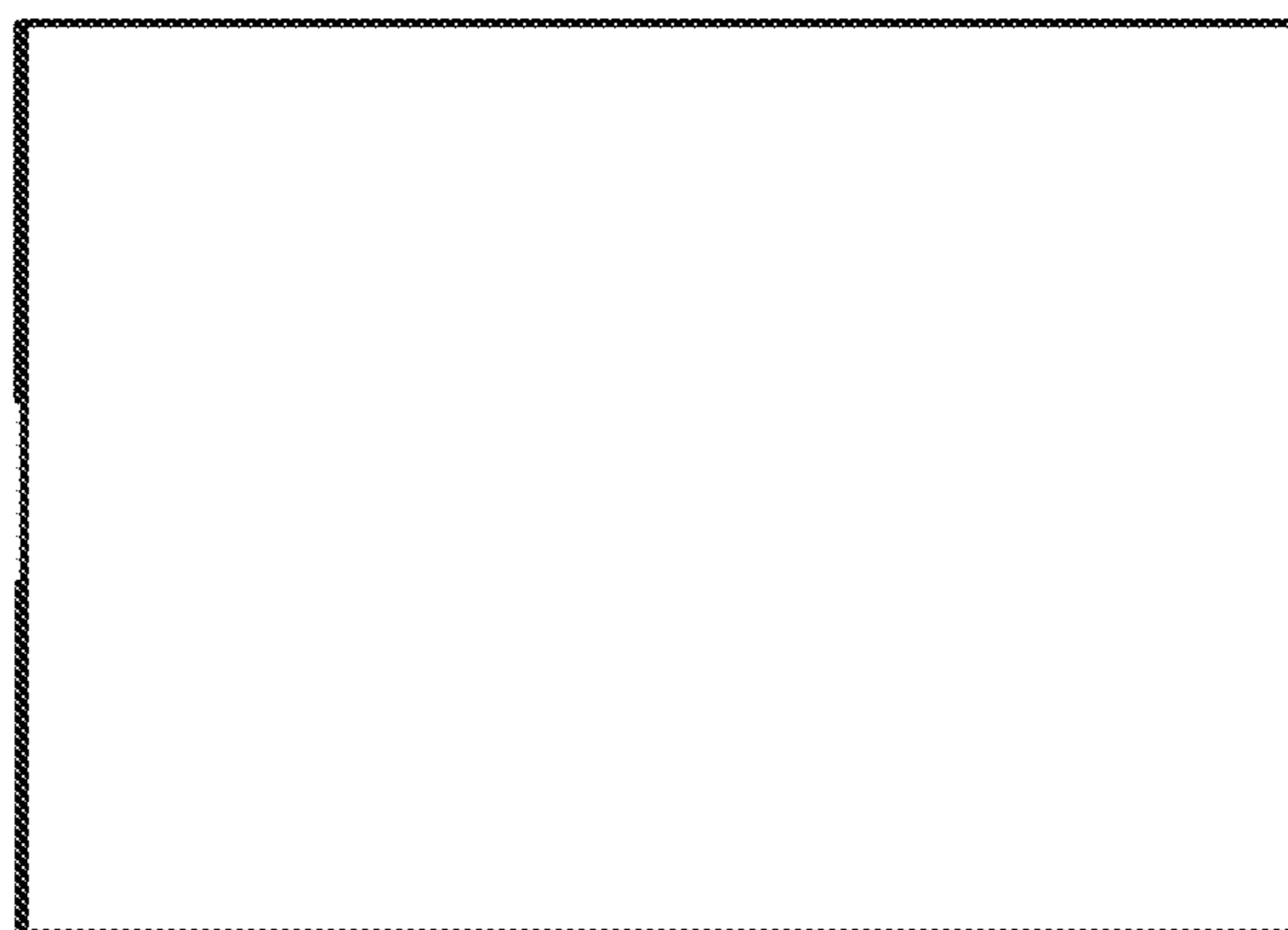

FIG. 7

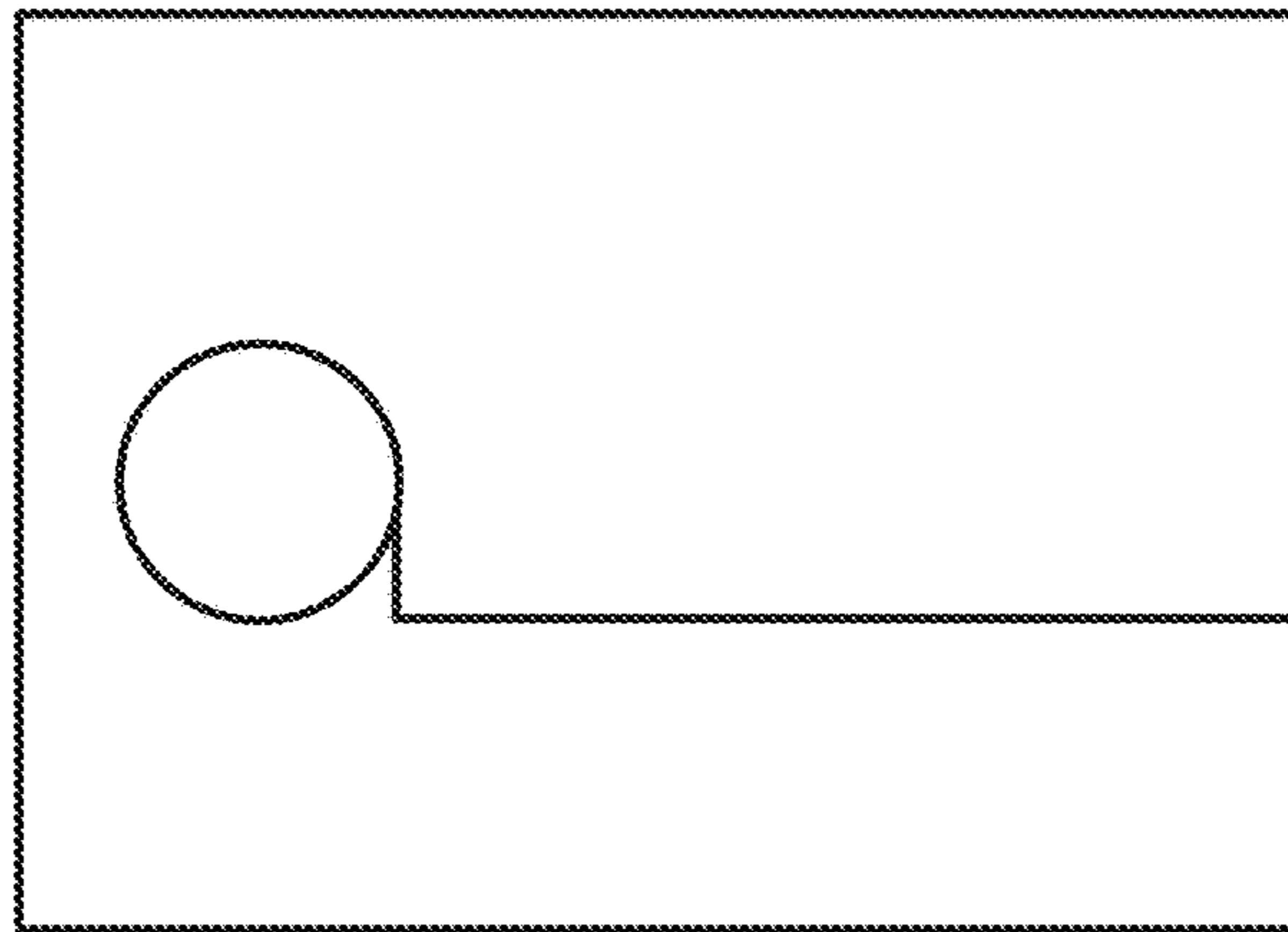

FIG. 8