



US00D860433S

(12) **United States Design Patent**
Haggar

(10) **Patent No.:** **US D860,433 S**

(45) **Date of Patent:** **** Sep. 17, 2019**

(54) **CEILING FAN BLADE**

(71) Applicant: **HUNTER FAN COMPNAY**, Memphis, TN (US)

(72) Inventor: **Alexander Jonathan Haggar**, Memphis, TN (US)

(73) Assignee: **Hunter Fan Company**, Memphis, TN (US)

(**) Term: **15 Years**

(21) Appl. No.: **29/641,208**

(22) Filed: **Mar. 20, 2018**

(51) **LOC (12) Cl.** **23-03**

(52) **U.S. Cl.**

USPC **D23/413**

(58) **Field of Classification Search**

USPC D23/314, 317, 324, 328, 332-342, 351, D23/352, 354, 355, 356, 359, 362, 364, D23/370-385, 386-389, 393, 397, D23/411-414; D12/214, 317, 339, 344, D12/345

CPC F04D 25/088; F04D 25/08; F04D 29/38; F04D 29/384; F04D 29/386; F04D 29/388; F04D 29/325; F04D 25/02; F04D 29/682; F04D 29/684

See application file for complete search history.

(56) **References Cited**

U.S. PATENT DOCUMENTS

D454,634 S *	3/2002	Frampton	D23/413
D454,636 S *	3/2002	Lantz	D23/413
D457,947 S *	5/2002	Tai	D23/413
D458,675 S *	6/2002	Tai	D23/413
D477,073 S *	7/2003	Hsieh	D23/413
D485,609 S	1/2004	Tai		
D485,897 S *	1/2004	Tai	D23/377
D491,262 S *	6/2004	Blateri	D23/413

D501,922 S *	2/2005	Hidalgo	D23/413
D502,770 S	3/2005	Hidalgo		
D503,228 S *	3/2005	Blateri	D23/413

(Continued)

OTHER PUBLICATIONS

<http://www.casablancafanco.com/Ceiling-Fans/Charthouse?ModelNumber=55073>, Casablanca Charthouse 54" Ceiling Fan in Onyx Bengal and 5 Xuracao Plastic Plastic Blades Included, Model No. 55073, accessed Sep. 19, 2017.

(Continued)

Primary Examiner — Cathron C Brooks

Assistant Examiner — Sharon S Oum

(74) *Attorney, Agent, or Firm* — McGarry Bair PC

(57) **CLAIM**

The ornamental design for a ceiling fan blade, as shown and described.

DESCRIPTION

FIG. 1 is a top perspective view of a ceiling fan blade according to my new invention, with a ceiling fan shown in broken lines.

FIG. 2 is a bottom front perspective view of the ceiling fan blade of FIG. 1;

FIG. 3 is a right side elevation view of the ceiling fan blade of FIG. 1;

FIG. 4 is a front elevation view of the ceiling fan blade of FIG. 1;

FIG. 5 is a left side elevation view of the ceiling fan blade of FIG. 1;

FIG. 6 is a top view of the ceiling fan blade of FIG. 1; and, FIG. 7 is a bottom view of the ceiling fan blade of FIG. 1.

The broken lines shown in FIG. 1 illustrate environmental structure, and the broken lines in the remaining views illustrate portions of the ceiling fan blade. None of the broken lines form part of the claimed design.

1 Claim, 7 Drawing Sheets

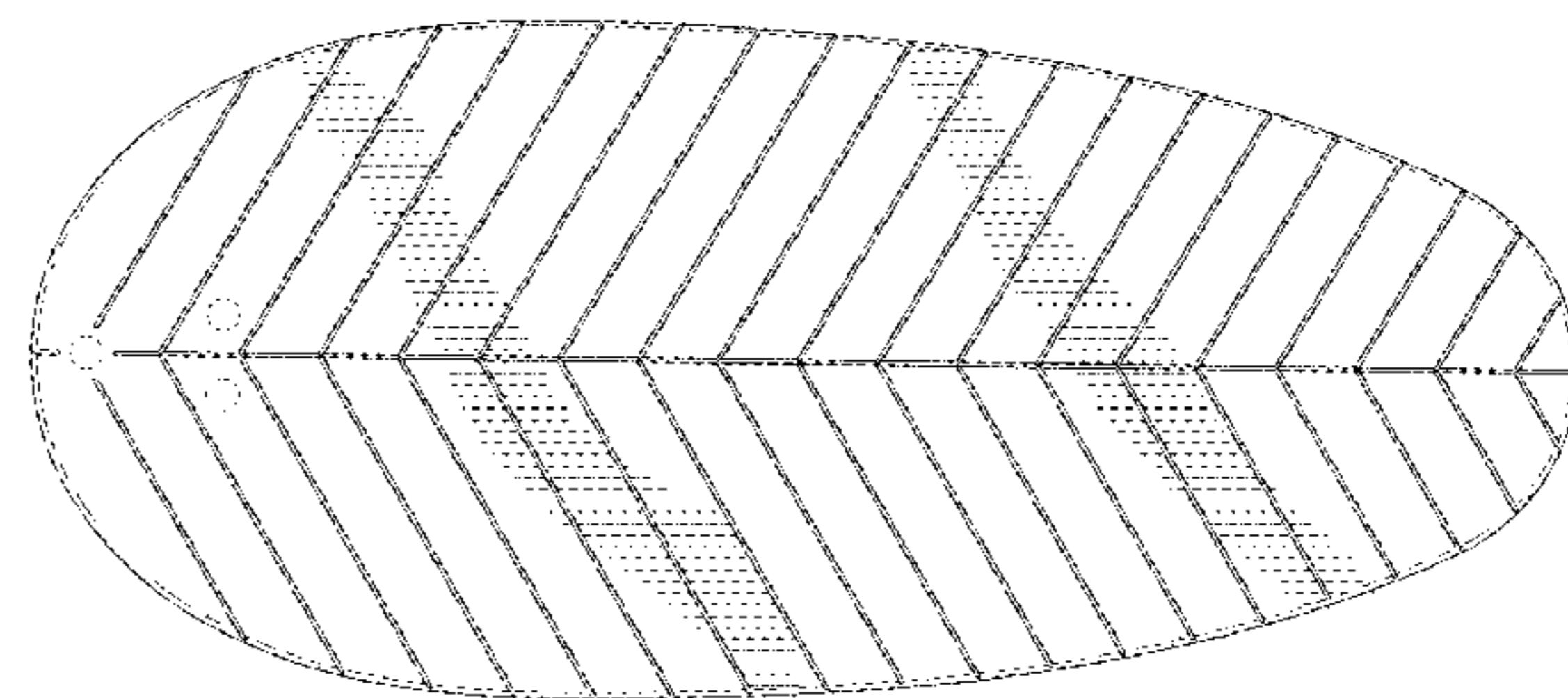
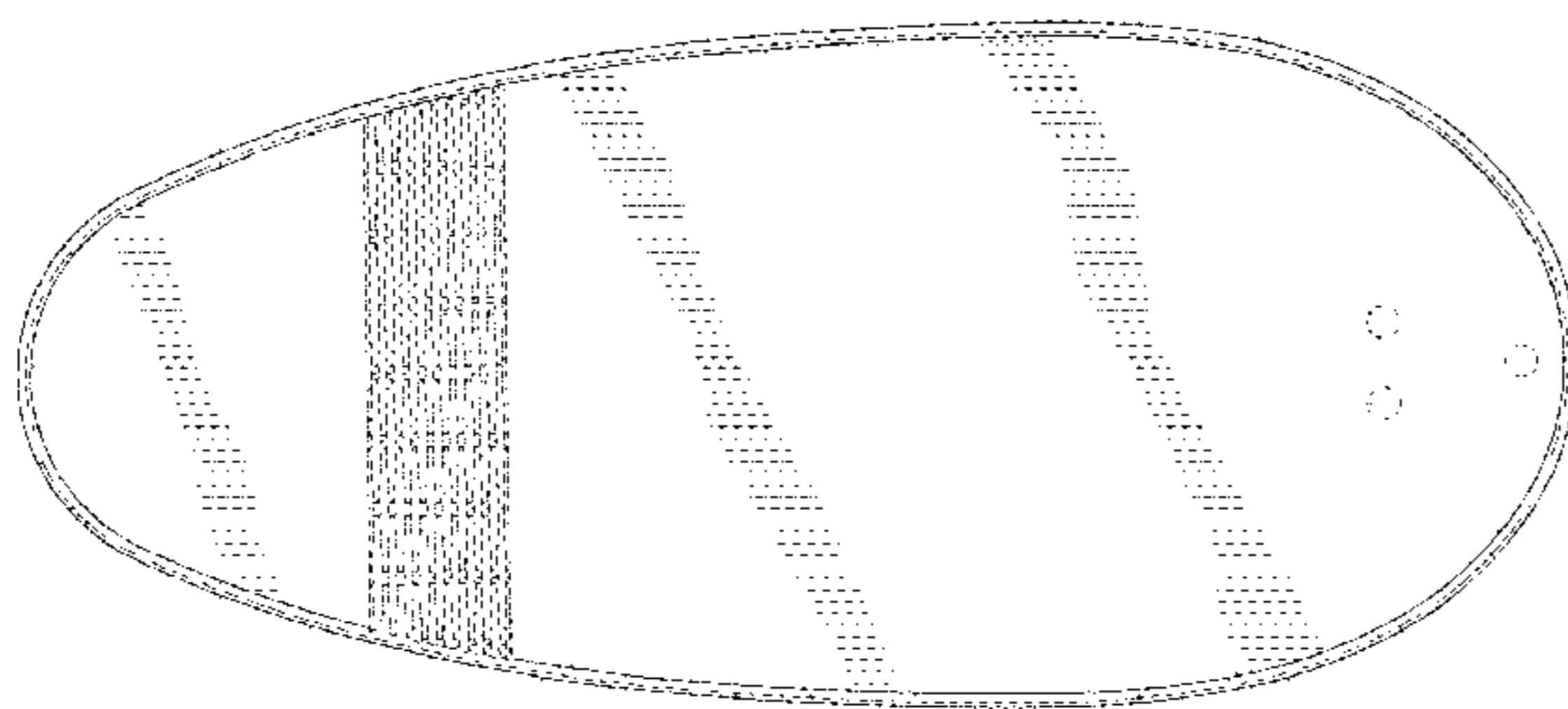

(56)

References Cited

U.S. PATENT DOCUMENTS

D506,826	S	*	6/2005	Frampton	D23/411
D507,646	S	*	7/2005	Young	D23/413
D509,294	S	*	9/2005	Young	D23/411
D510,424	S		10/2005	Young		
D514,215	S	*	1/2006	Hidalgo	D23/377
D515,195	S	*	2/2006	Young	D23/377
D516,712	S	*	3/2006	Pickett	D23/413
D517,201	S	*	3/2006	Gajewski	D23/413
D517,685	S	*	3/2006	Frampton	D23/413
D519,199	S		4/2006	Gajewski		
D522,643	S	*	6/2006	Hidalgo	D23/377
D525,694	S		7/2006	Young		
D565,168	S	*	3/2008	Hidalgo	D23/377
D575,864	S	*	8/2008	Parker	D23/413
D597,649	S	*	8/2009	Frampton	D23/377
D597,650	S	*	8/2009	Orozco	D23/377
D627,457	S	*	11/2010	Klausing	D23/413
D632,382	S		2/2011	Pan		
D633,194	S	*	2/2011	Frampton	D23/413
D636,480	S	*	4/2011	Frampton	D23/377
D672,026	S	*	12/2012	Glasbrenner	D23/377
D672,448	S	*	12/2012	Passauer, III	D23/377
D707,340	S		6/2014	Pan		
D714,925	S		10/2014	Pan		
D745,134	S	*	12/2015	Wang	D23/413
D799,689	S	*	10/2017	Wang	D23/413
2005/0002792	A1	*	1/2005	Cartwright	F04D 25/088 416/210 R
2006/0034696	A1	*	2/2006	Chen	F04D 29/388 416/229 R

OTHER PUBLICATIONS

<http://www.kingoffans.com/#/products>, Hampton Bay III 48 in. Indoor/Outdoor Matte White Ceiling Fan, Model No. 51469, accessed Sep. 19, 2017.

<http://ceilingfans.emerson.com/shop/en/fan/fans-s-emerson-fans/fans-s-indoor-outdoor/batalie-breeze-fan-p-cf621>, Tropical Indoor/Outdoor Ceiling Fan in Bronze, Model No. P-CF621, accessed Sep. 20, 2017.

<http://www.kichler.com/products/product/52-klever-abs-white-bamboo-fan-blades-ww-370052.aspx>, Kichler Clever Collection, 52" Klever ABS White Bamboo Fan Blades WW, Model No. 370052, accessed Sep. 20, 2017.

<https://www.lowes.com/pd/Harbor-Breeze-Tilghman-52-in-New-Bronze-Indoor-Outdoor-Downrod-Or-Close-Mount-Ceiling-Fan-ENERGY-STAR/50102868>, Harbor Breeze Tilghman 52-In New Bronze Indoor/Outdoor Downrod or Close Mount Ceiling Fan, Model No. WCK52NWZ5N, accessed Sep. 20, 2017.

<http://www.fanimation.com/products/index.php/blades/60-inch-distinction-buttonwood-blade-set-with-woven-wicker.html>, Fanimation 60" Sweep Distinction Buttonwood Blade Set with Woven Wicker Blades, Model No. B560, accessed Sep. 20, 2017.

<http://www.kingoffans.com/#/products>, King of Fans Palm Beach Ceiling Fan in Galvanized Weathered Resistant, Model No. 72566, accessed Sep. 19, 2017.

<http://www.hunterfan.com/Ceiling-Fans/Caribbean-Breeze?ModelNumber=54094>, Hunter Fan Caribbean Breeze 54" Ceiling Fan with 5Wicker Blades Included, Model No. 54094 in Textured White Finish, accessed Sep. 19, 2017.

<http://www.hunterfan.com/Ceiling-Fans/Bayview?ModelNumber=54097>, Hunter Fan Bayview 54" Ceiling Fan with 5 White Wicker / Whitel Palm Leaf Reversible Plastic Blades Included, Model No. 54097, accessed Sep. 19, 2017.

http://www.cens.com/cens/html/en/product/product_main_77127.html, Air Cool Industrial Co., Ltd, Jupiter-Champagne Lights Series of Ceiling Fan, Model No. YG075, accessed Sep. 20, 2017.

<https://www.lowes.com/pd/Harbor-Breeze-Pacific-Grove-52-in-Oil-rubbed-bronze-Indoor-Outdoor-Downrod-Or-Close-Mount-Ceiling-Fan-ENERGY-STAR/1000083285>, Harbor Breeze Pacific Grove 52 in. Oil Rubbed Bronze Indoor/Outdoor Downrod or Close Mount Ceiling Fan, Model No. 40945, accessed Sep. 20, 2017.

<http://www.kingoffans.com/#/products>, King of Fans Palm Beach III, in Natural Iron with Multi-Tone Brown Wicker Finish, Model No. 51499, accessed Sep. 20, 2017.

* cited by examiner

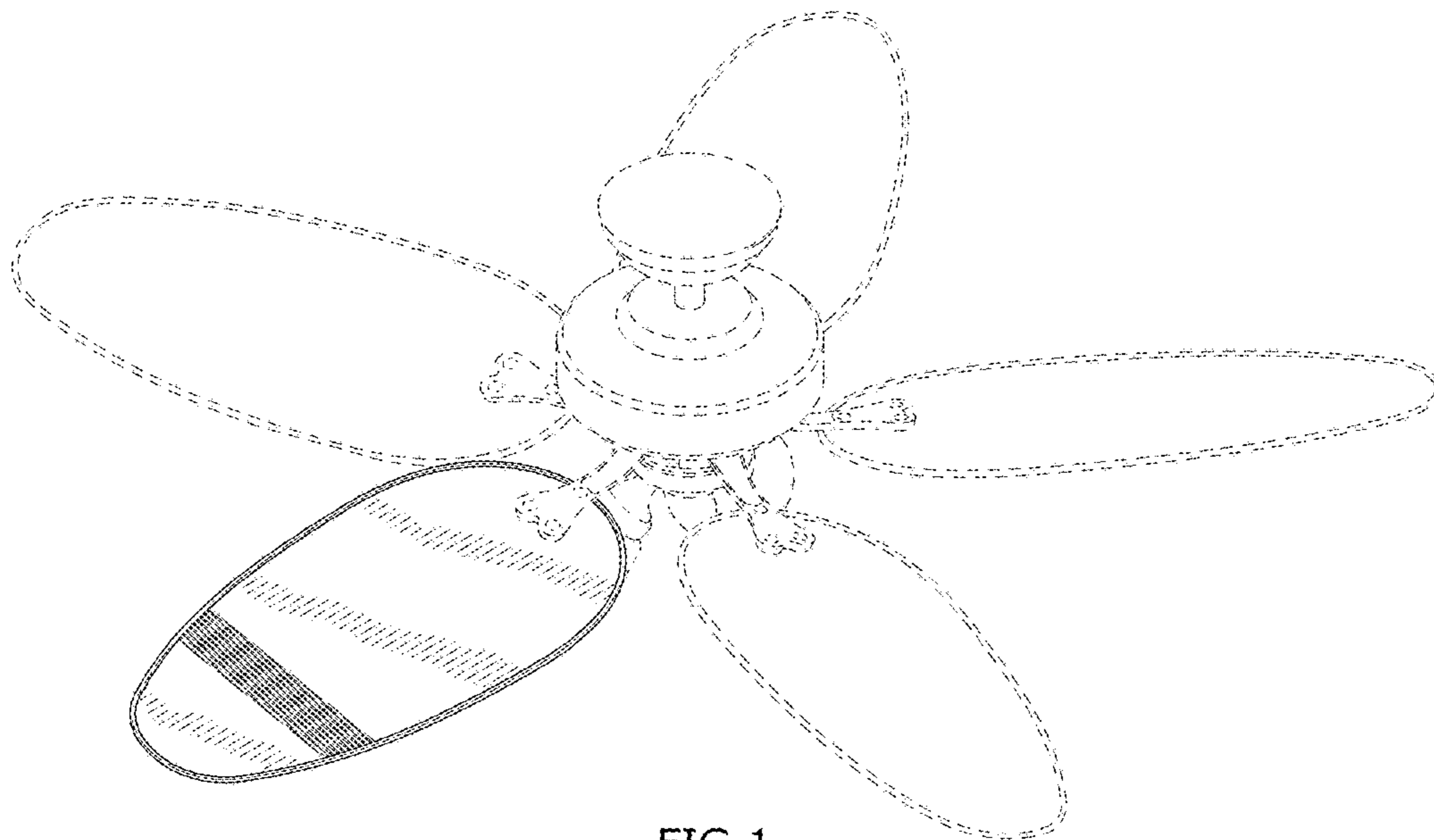

FIG. 1

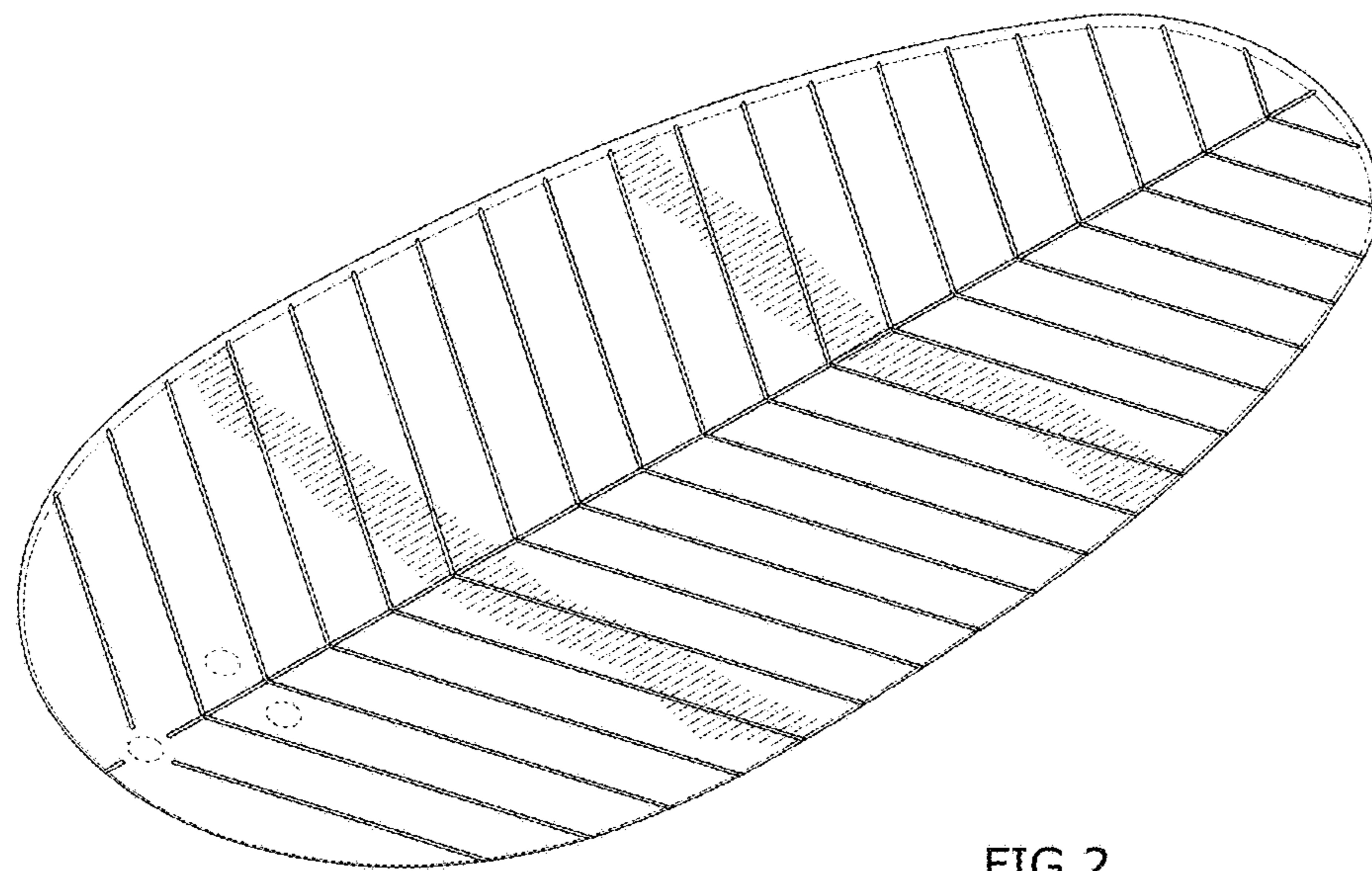

FIG.2

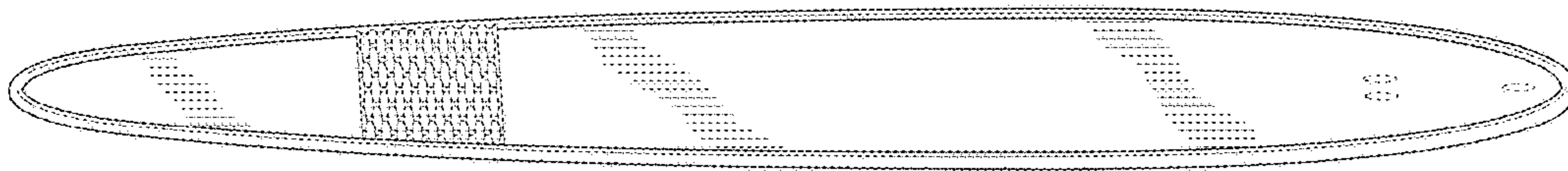

FIG.3

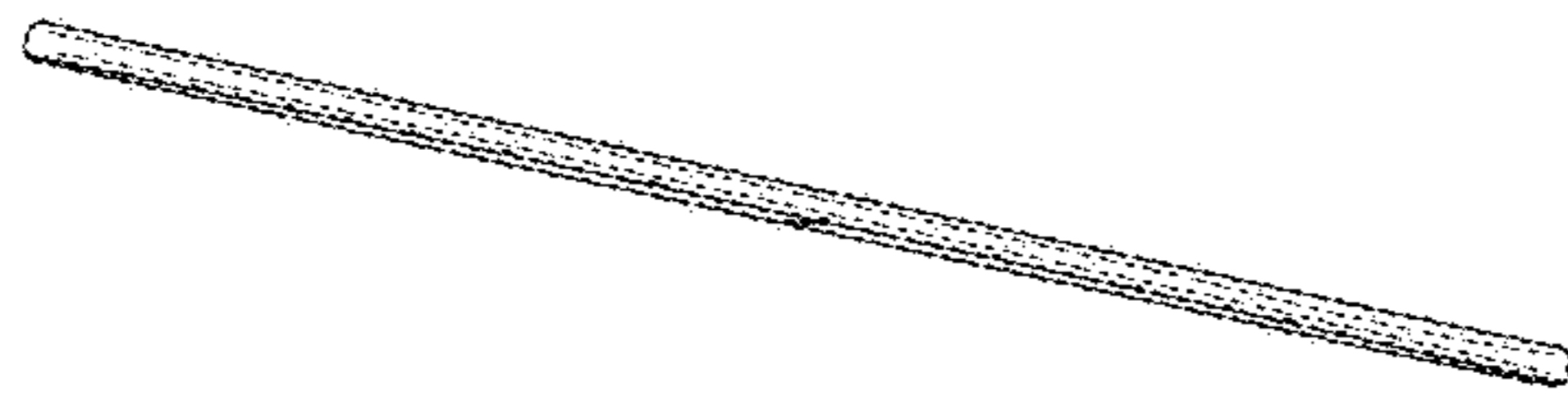

FIG.4

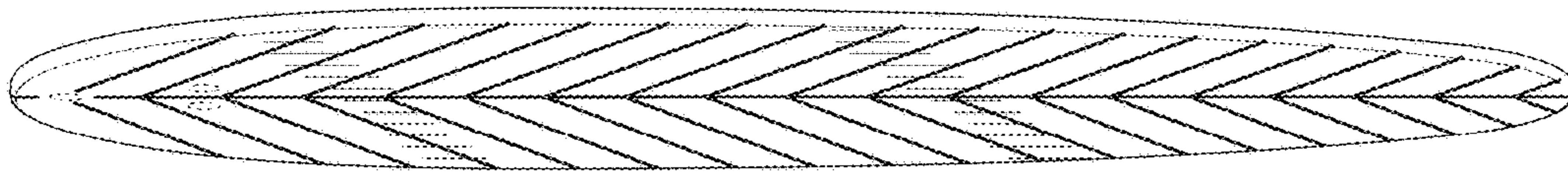

FIG. 5

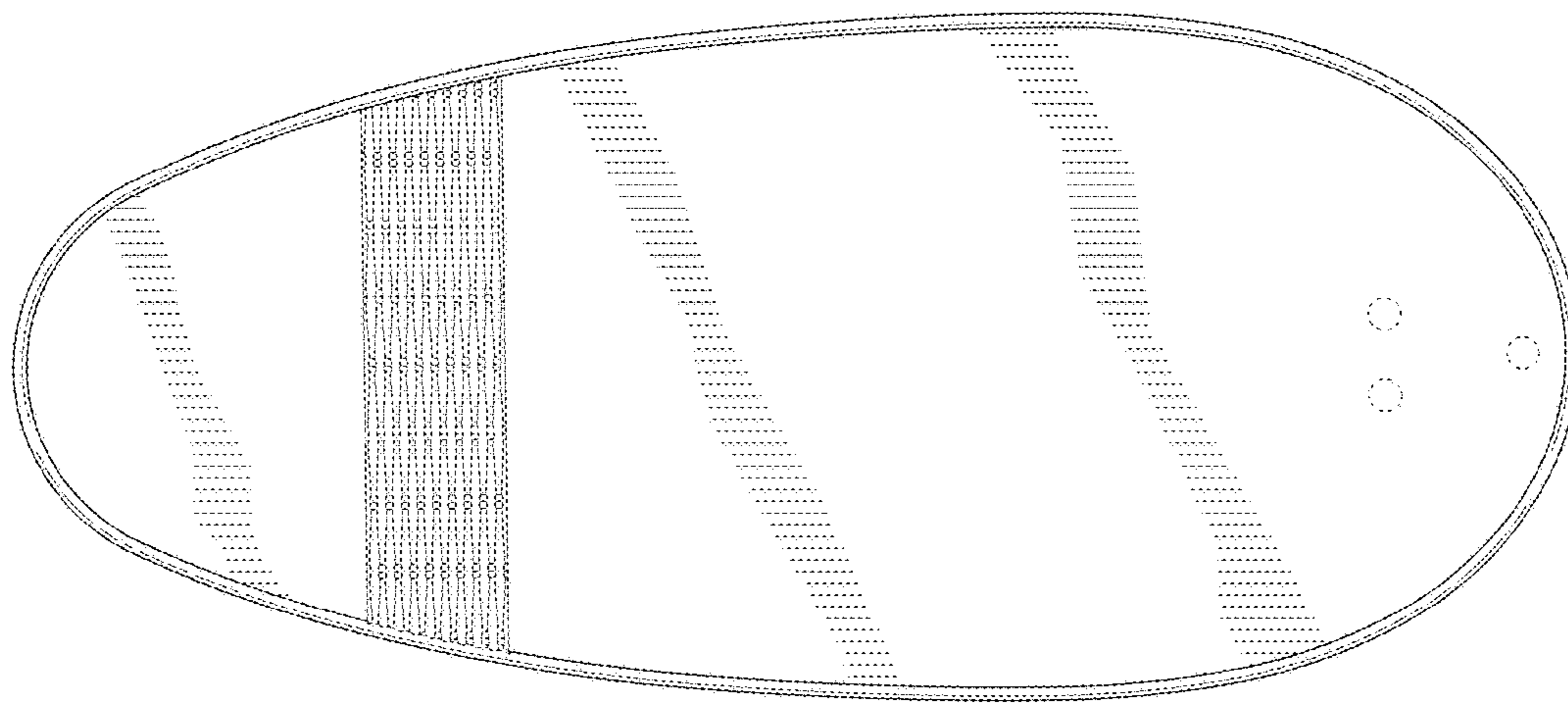

FIG. 6

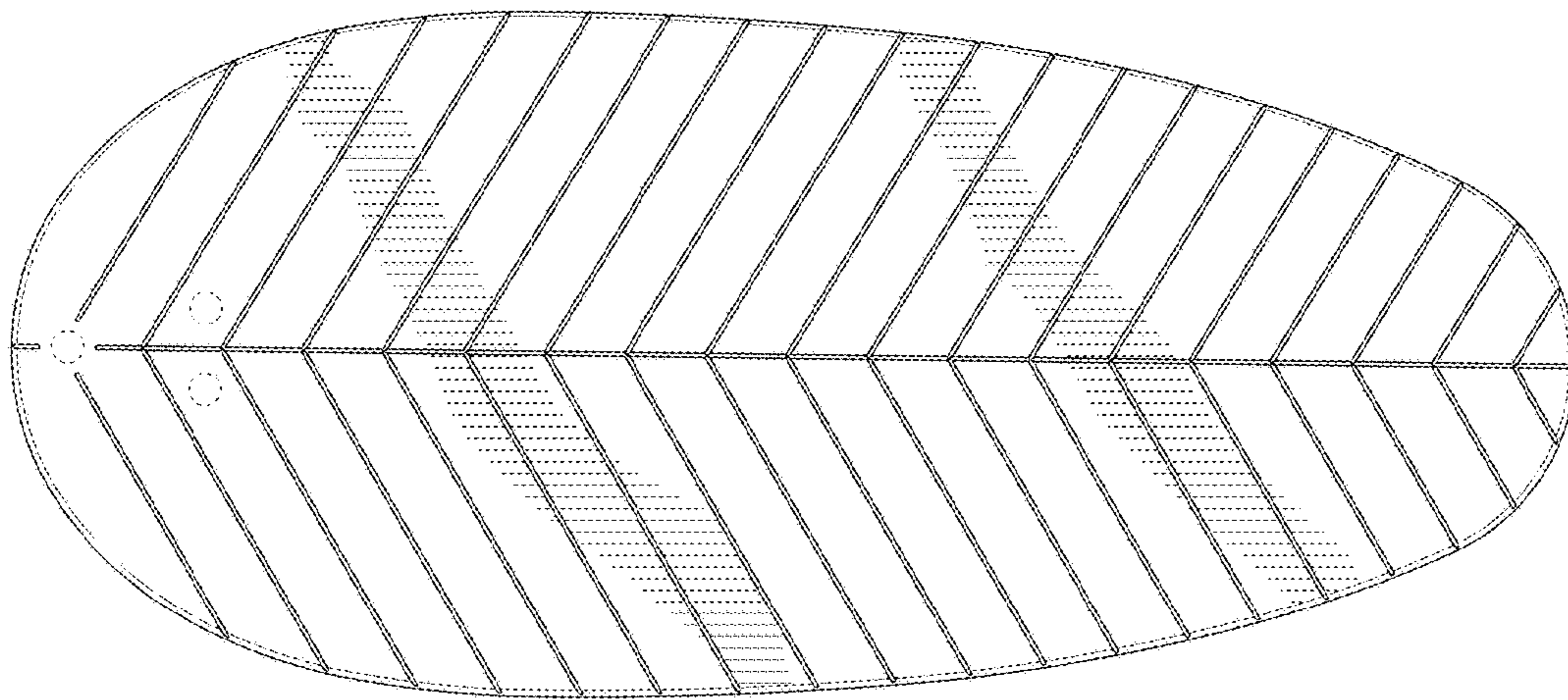

FIG. 7