

US00D860370S

(12) **United States Design Patent** (10) **Patent No.:** **US D860,370 S**
Huber (45) **Date of Patent:** **** Sep. 17, 2019**

- (54) **GUN SLING**
- (71) Applicant: **Hunter Fox Huber**, Richmond, VA (US)
- (72) Inventor: **Hunter Fox Huber**, Richmond, VA (US)
- (73) Assignee: **HHRC Company LLC**, Richmond, VA (US)
- (**) Term: **15 Years**
- (21) Appl. No.: **29/623,233**
- (22) Filed: **Oct. 24, 2017**
- (51) **LOC (12) Cl.** **22-01**
- (52) **U.S. Cl.**
USPC **D22/108**
- (58) **Field of Classification Search**
USPC D22/134–143; D8/356; D3/214–215,
D3/221, 262, 327–328; D29/101.1, 101.2
CPC A45F 3/12; A45F 2003/142; F41C 33/002;
F41C 33/001; F41C 33/006; F41C
33/007; F41C 23/02; Y10T 24/45283
See application file for complete search history.

- (56) **References Cited**
U.S. PATENT DOCUMENTS
2,481,884 A * 9/1949 Short F41C 33/001
224/150
2,830,747 A * 4/1958 Creste F41C 23/02
224/150
5,353,538 A * 10/1994 Hakedal F41C 23/02
224/150
6,131,780 A * 10/2000 Becker A45F 3/04
224/148.6

- 7,516,591 B2 * 4/2009 Wolner A62B 35/0068
119/795
- 2004/0245297 A1 * 12/2004 Sinclair F41C 33/002
224/150
- 2008/0018122 A1 * 1/2008 Zierler F41C 23/02
294/74
- 2011/0006088 A1 * 1/2011 Matthews F41C 33/002
224/150
- 2017/0064928 A1 * 3/2017 Seuk A01K 27/003
- 2017/0266071 A1 * 9/2017 Bogie A61G 5/1045
- 2018/0085618 A1 * 3/2018 Cummings A63B 23/047
- 2018/0161192 A1 * 6/2018 Sudell A61F 5/048
- 2019/0038183 A1 * 2/2019 Carr A61B 5/1115

* cited by examiner

Primary Examiner — Michael A. Pratt
(74) *Attorney, Agent, or Firm* — NK Patent Law

(57) **CLAIM**

I claim the ornamental design for the gun sling, as shown and described.

DESCRIPTION

FIG. 1 is a perspective view of a gun sling;
FIG. 2 is a front facing view of the gun sling;
FIG. 3 is a back facing view of the gun sling;
FIG. 4 is a side facing, perspective view of the gun sling;
FIG. 5 is a view of an end buckle of the gun sling;
FIG. 6 is a view of a second end buckle of the gun sling;
FIG. 7 is an enlarged partial view of the of the front of the gun sling; It being understood that the pattern shown in FIG. 7 extends the entire length of the gun sling; and,
FIG. 8 is a perspective view of the gun sling.
The portions shown in broken lines form no portion of the claimed invention.

1 Claim, 7 Drawing Sheets

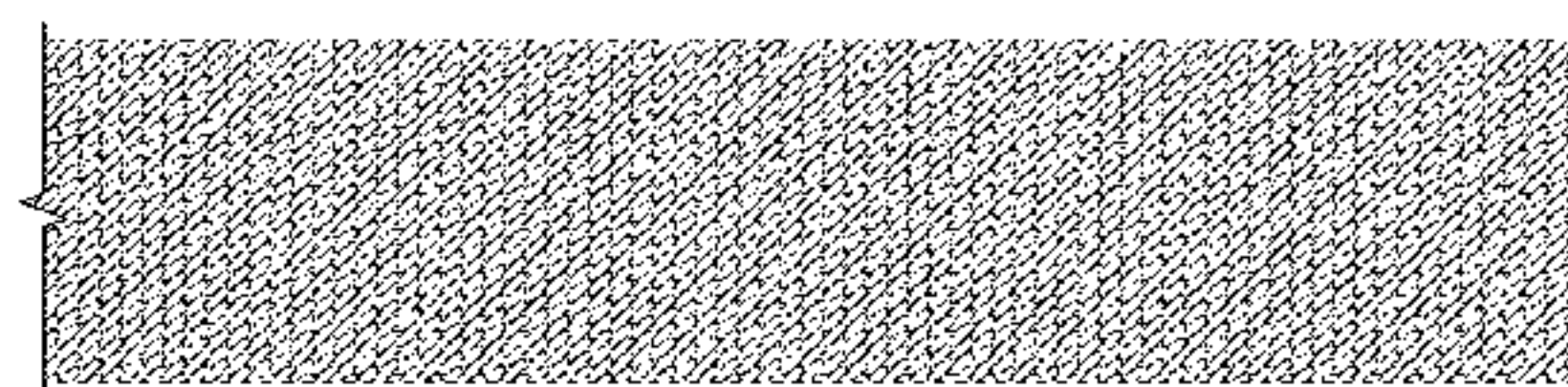
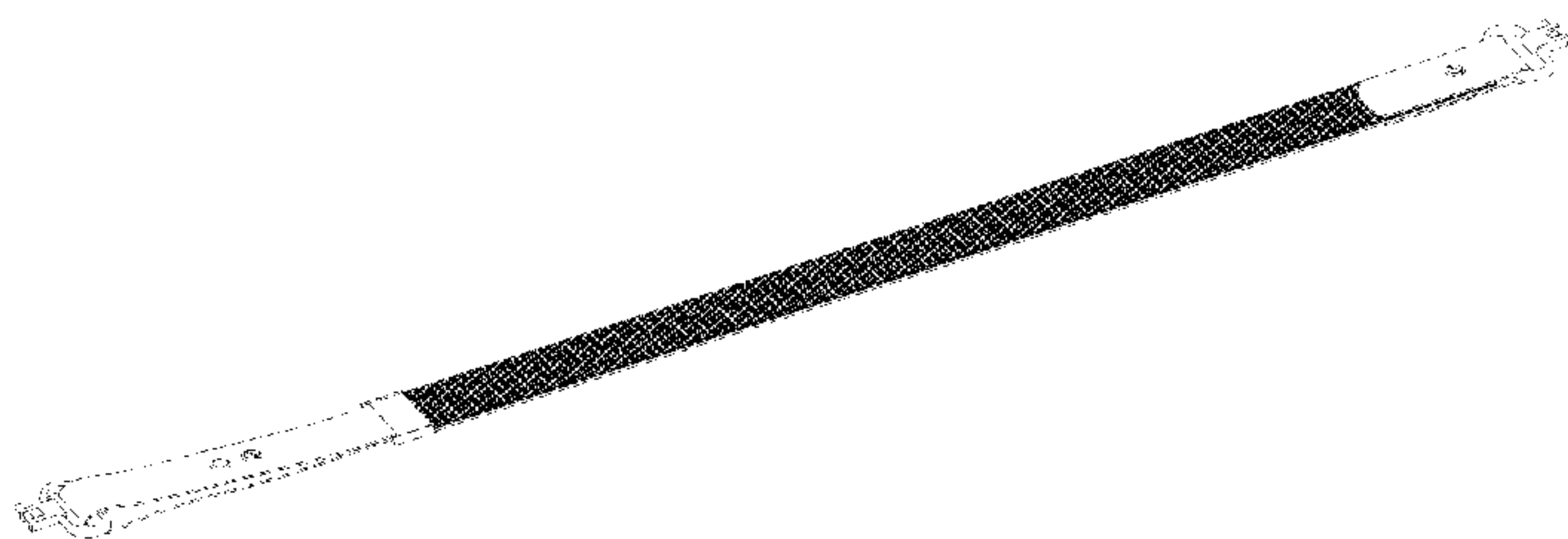

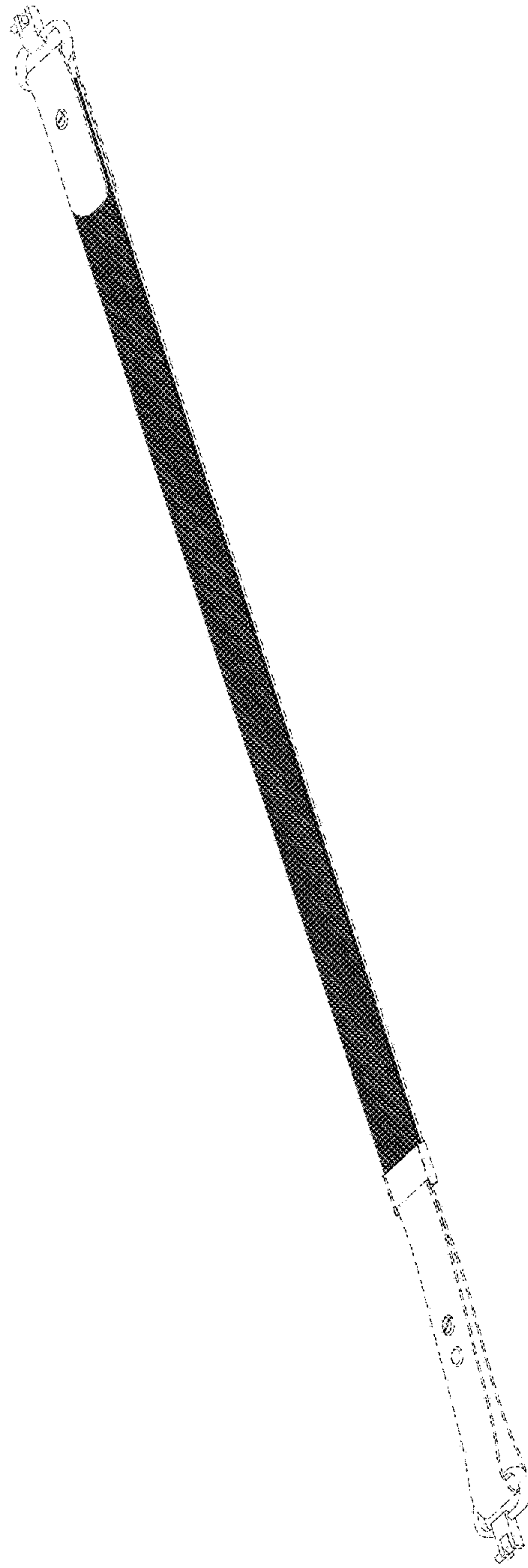

FIG. 1

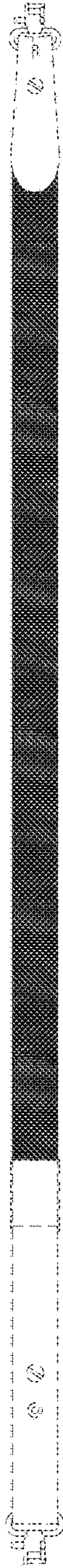

FIG. 2

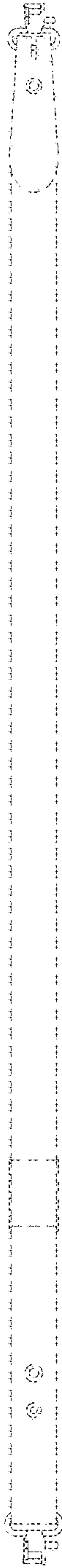

FIG. 3



FIG. 4

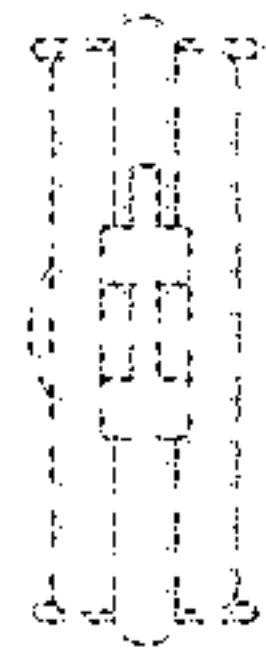

FIG. 6



FIG. 5

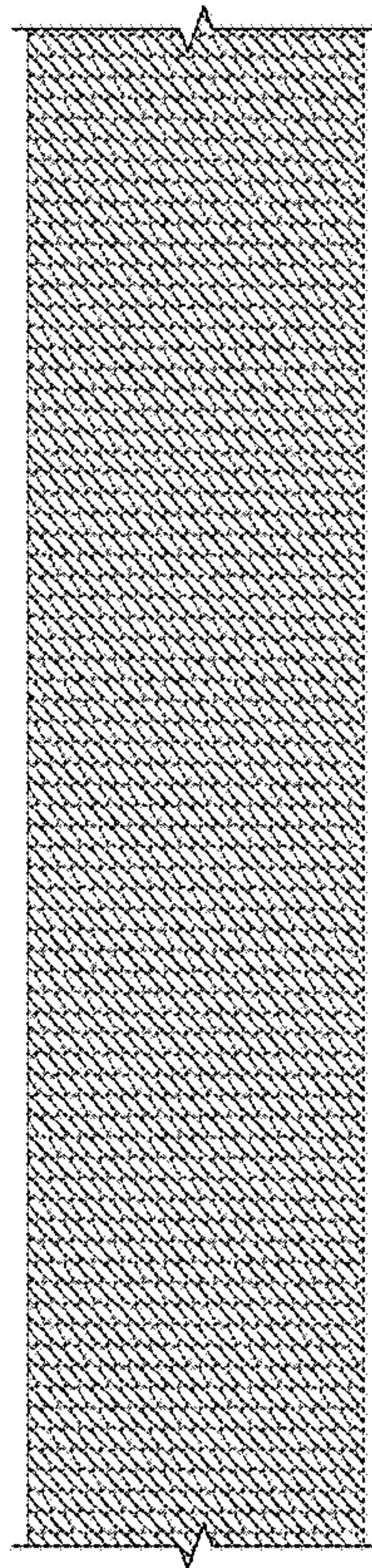

FIG. 7

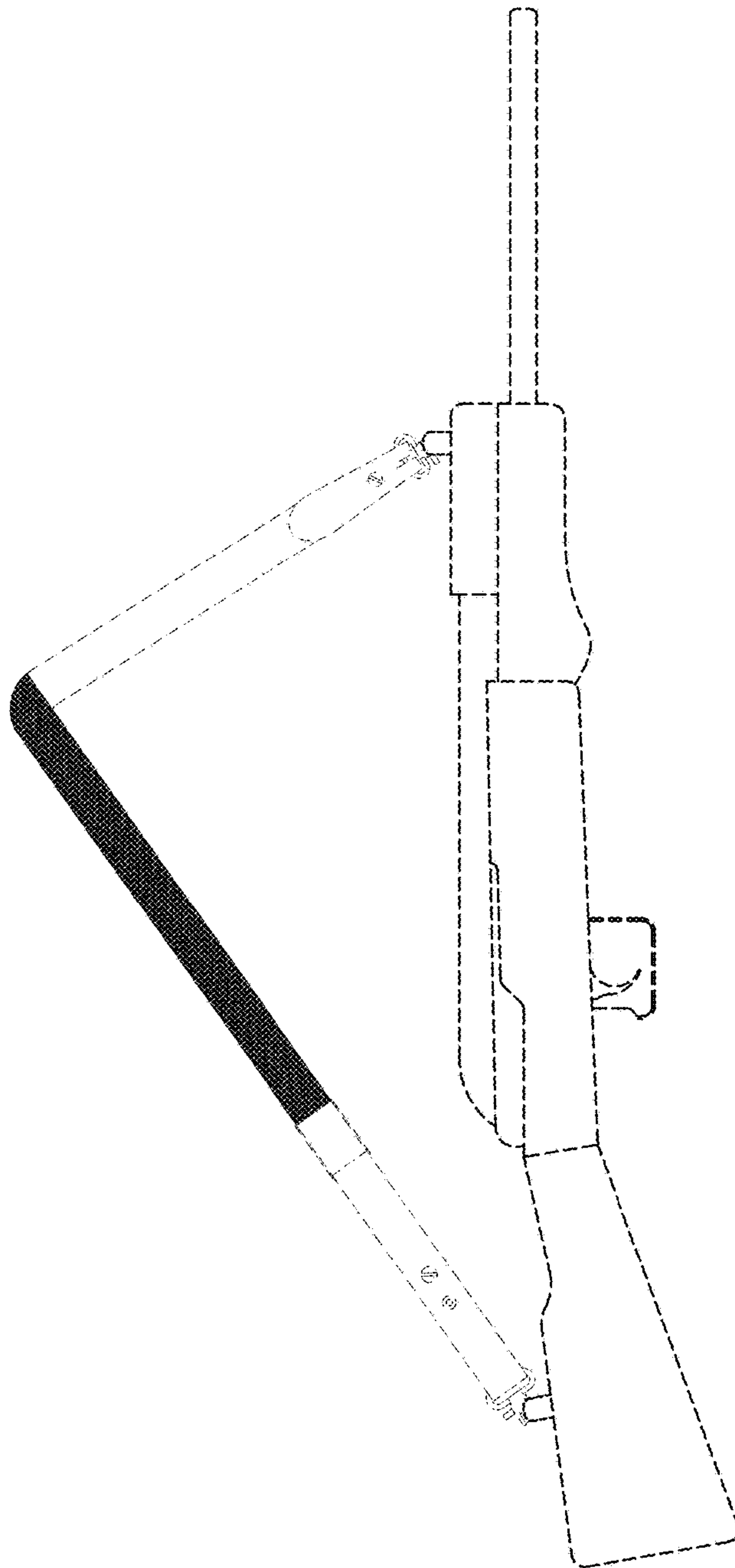

FIG. 8