

US00D860339S

(12) **United States Design Patent** (10) **Patent No.:** **US D860,339 S**
Sun (45) **Date of Patent:** **** Sep. 17, 2019**

(54) **EXERCISE BICYCLE**
(71) Applicant: **SUNNY HEALTH & FITNESS (XIAMEN) CO., LTD.**, Xiamen, Fujian (CN)
(72) Inventor: **Yu Sun**, Fujian (CN)
(73) Assignee: **SUNNY HEALTH & FITNESS (XIAMEN) CO., LTD.**, Xiamen (CN)
(**) Term: **15 Years**
(21) Appl. No.: **29/636,181**
(22) Filed: **Feb. 6, 2018**
(51) **LOC (12) Cl.** **21-02**
(52) **U.S. Cl.**
USPC **D21/667**
(58) **Field of Classification Search**
USPC D21/663, 667, 666, 697, 694, 665, 668, D21/664, 690, 676, 670; 74/502.4, 502.6, 74/594.2, 594.1, 48; D12/178, 411, 345; D23/382, 381, 378, 412, 411; D13/115; D15/7; 482/57, 62, 111, 139, 145, 60, 482/51, 123, 72, 61, 58, 9
CPC ... A63B 22/0605; A63B 21/225; A63B 69/16; A63B 2022/0652; A63B 2069/165; A63B 21/015; A61H 1/0214; A61H 2201/1215; Y10T 74/2164
See application file for complete search history.

D281,520 S * 11/1985 Kiiski D21/667
D282,190 S * 1/1986 Bell D21/667
D282,191 S * 1/1986 Bell D21/667
D283,431 S * 4/1986 Gustafsson D21/667
D285,953 S * 9/1986 Gustafsson D21/667
4,625,963 A * 12/1986 Lancellotti A63B 21/04 482/130
D291,462 S * 8/1987 Aalto D21/667
D291,713 S * 9/1987 Kiiski D21/667
D293,598 S * 1/1988 Kiiski D21/667
D296,457 S * 6/1988 Anitua D21/667
D299,504 S * 1/1989 Hong D21/667
D299,732 S * 2/1989 Gustafsson D21/667
D307,166 S * 4/1990 Wu D21/667
D323,863 S * 2/1992 Watterson D21/667
D372,284 S * 7/1996 Wang D21/667
D380,796 S * 7/1997 Wang D21/667
D382,924 S * 8/1997 Wu D21/667
D382,925 S * 8/1997 Wu D21/667
D460,794 S * 7/2002 Baker D21/667
D473,602 S * 4/2003 Baudhuin D21/667

(Continued)

Primary Examiner — Ryan Harvey

(57) **CLAIM**

The ornamental design for an exercise bicycle, as shown and described.

DESCRIPTION

FIG. 1 is a front elevational view of an exercise bicycle showing my new design;
FIG. 2 is a rear elevational view thereof;
FIG. 3 is a left side view thereof;
FIG. 4 is a right side view thereof;
FIG. 5 is a top plan view thereof;
FIG. 6 is a top, front and right side perspective view thereof; and,
FIG. 7 is a top, rear and left side perspective view thereof.
The broken lines in the drawings illustrate portions of the exercise bicycle which form no part of the claimed design.

1 Claim, 7 Drawing Sheets

(56) **References Cited**
U.S. PATENT DOCUMENTS
D254,679 S * 4/1980 Gustafsson D21/667
D275,589 S * 9/1984 Gustafsson D21/667
D280,003 S * 8/1985 Kiiski D21/667
D280,226 S * 8/1985 Kasuba D21/667
D280,923 S * 10/1985 Smith D21/667

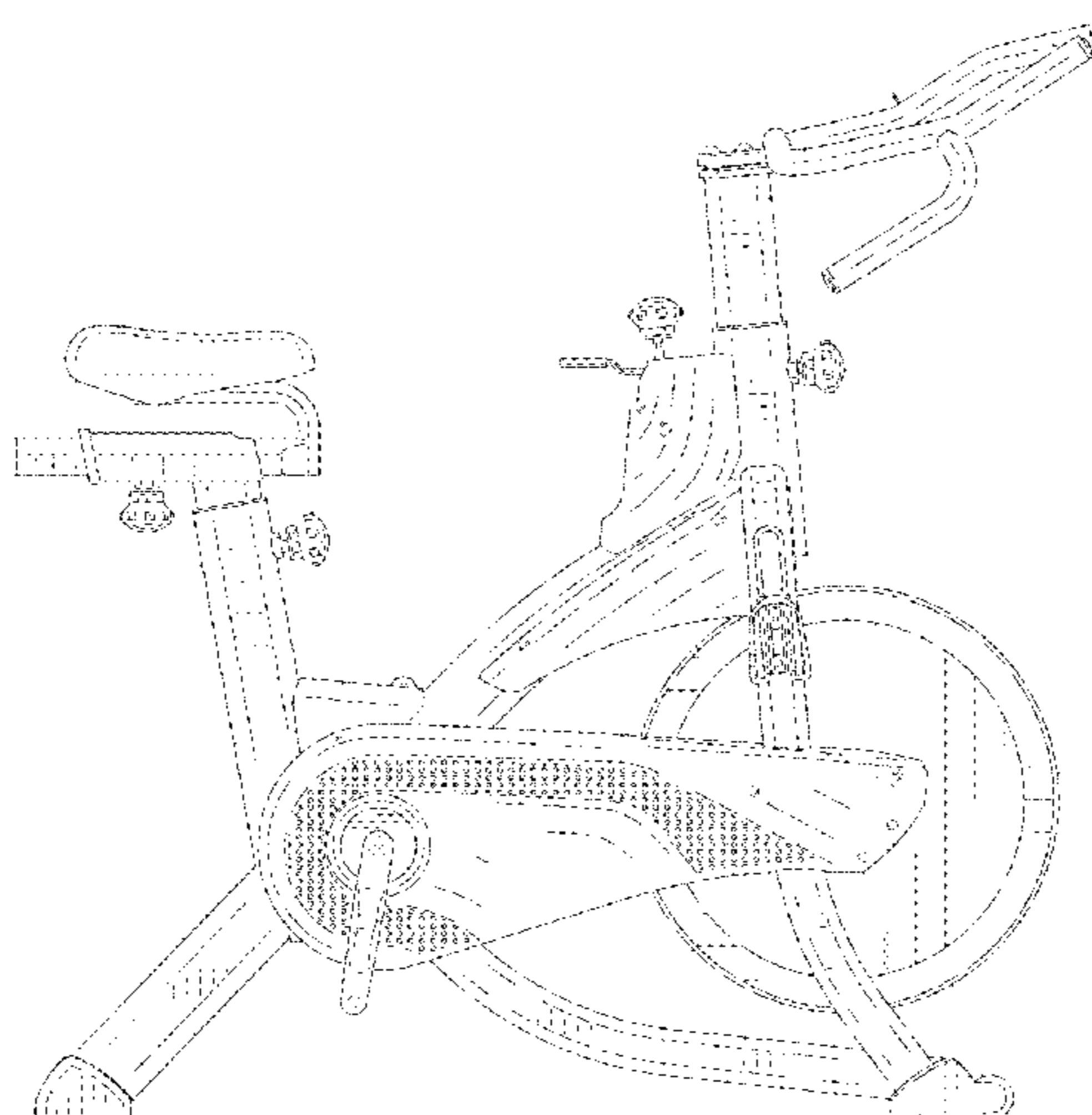

(56)

References Cited

U.S. PATENT DOCUMENTS

6,905,445	B1 *	6/2005	Lin	A63B 21/012	2002/0160887	A1 *	10/2002	Warner	A63B 21/157
					188/24.11						482/57
6,918,860	B1 *	7/2005	Nusbaum	A63B 24/0087	2003/0092534	A1 *	5/2003	Forcillo	A63B 21/015
					463/37						482/57
D532,063	S *	11/2006	Kim	D21/697	2003/0171191	A1 *	9/2003	Crawford	B62K 21/12
D571,417	S *	6/2008	Su	D21/667						482/57
7,413,530	B2 *	8/2008	Warner	A63B 21/157	2004/0248701	A1 *	12/2004	Baker	A63B 22/0605
					482/57						482/57
D579,989	S *	11/2008	Bingham, Jr.	D21/667	2005/0221961	A1 *	10/2005	Forcillo	A63B 21/225
7,641,600	B2 *	1/2010	Bingham, Jr.	A63B 22/00						482/57
					24/516	2009/0227429	A1 *	9/2009	Baudhuin	G16H 40/20
D616,050	S *	5/2010	Lull	D21/667						482/57
D624,612	S *	9/2010	Watt	D21/667	2010/0009815	A1 *	1/2010	Chen	A63B 21/00069
D625,762	S *	10/2010	Fon	D21/667						482/63
D636,449	S *	4/2011	Wu	D21/667	2010/0125029	A1 *	5/2010	Nielson	A63B 22/0605
D649,203	S *	11/2011	Zhang	D21/667						482/61
D649,204	S *	11/2011	Zhang	D21/667	2010/0234185	A1 *	9/2010	Watt	A63B 21/0051
D649,607	S *	11/2011	Lull	D21/697						482/8
D676,508	S *	2/2013	Wu	D21/667	2010/0234188	A1 *	9/2010	Wan	A63B 69/16
D677,349	S *	3/2013	Baudhuin	D21/667						482/61
D677,746	S *	3/2013	Baudhuin	D21/667	2011/0105282	A1 *	5/2011	Pinzon	A63B 22/0605
D682,371	S *	5/2013	Baudhuin	D21/667						482/57
D682,954	S *	5/2013	Cornejo	D21/667	2012/0088637	A1 *	4/2012	Lull	A63B 21/015
D684,223	S *	6/2013	Cornejo	D21/667						482/57
D709,566	S *	7/2014	Baudhuin	D21/667	2014/0038781	A1 *	2/2014	Foley	A63B 24/0075
D794,724	S *	8/2017	Tasca	D21/663						482/9
2002/0032105	A1 *	3/2002	Herb, Jr.	A63B 21/026	2015/0111704	A1 *	4/2015	Lin	A63B 22/0605
					482/57						482/57
						2015/0238808	A1 *	8/2015	Lin	A63B 22/0605
											482/57
						2016/0263417	A1 *	9/2016	Golesh	A63B 21/00069

* cited by examiner

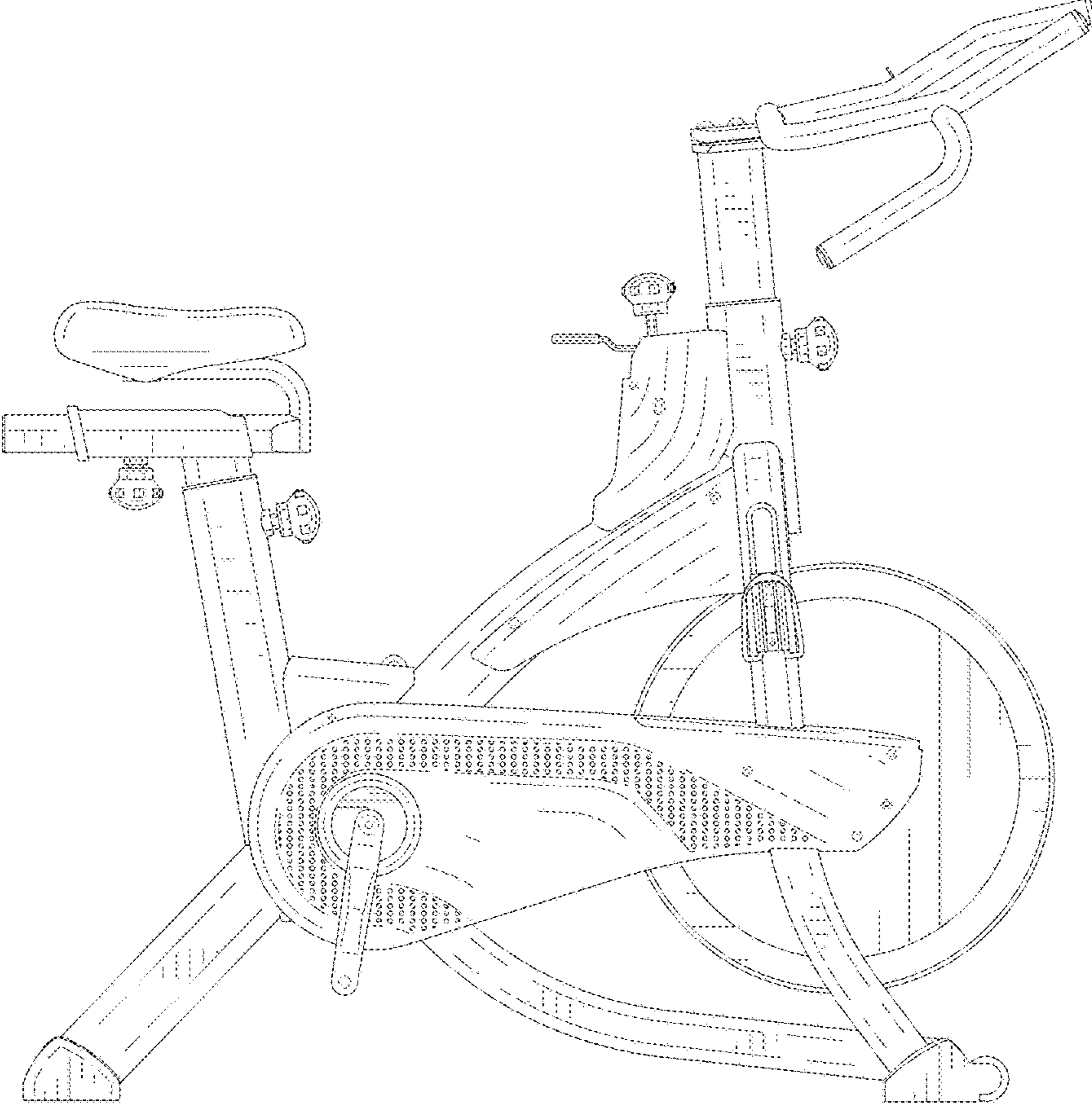

FIG. 1

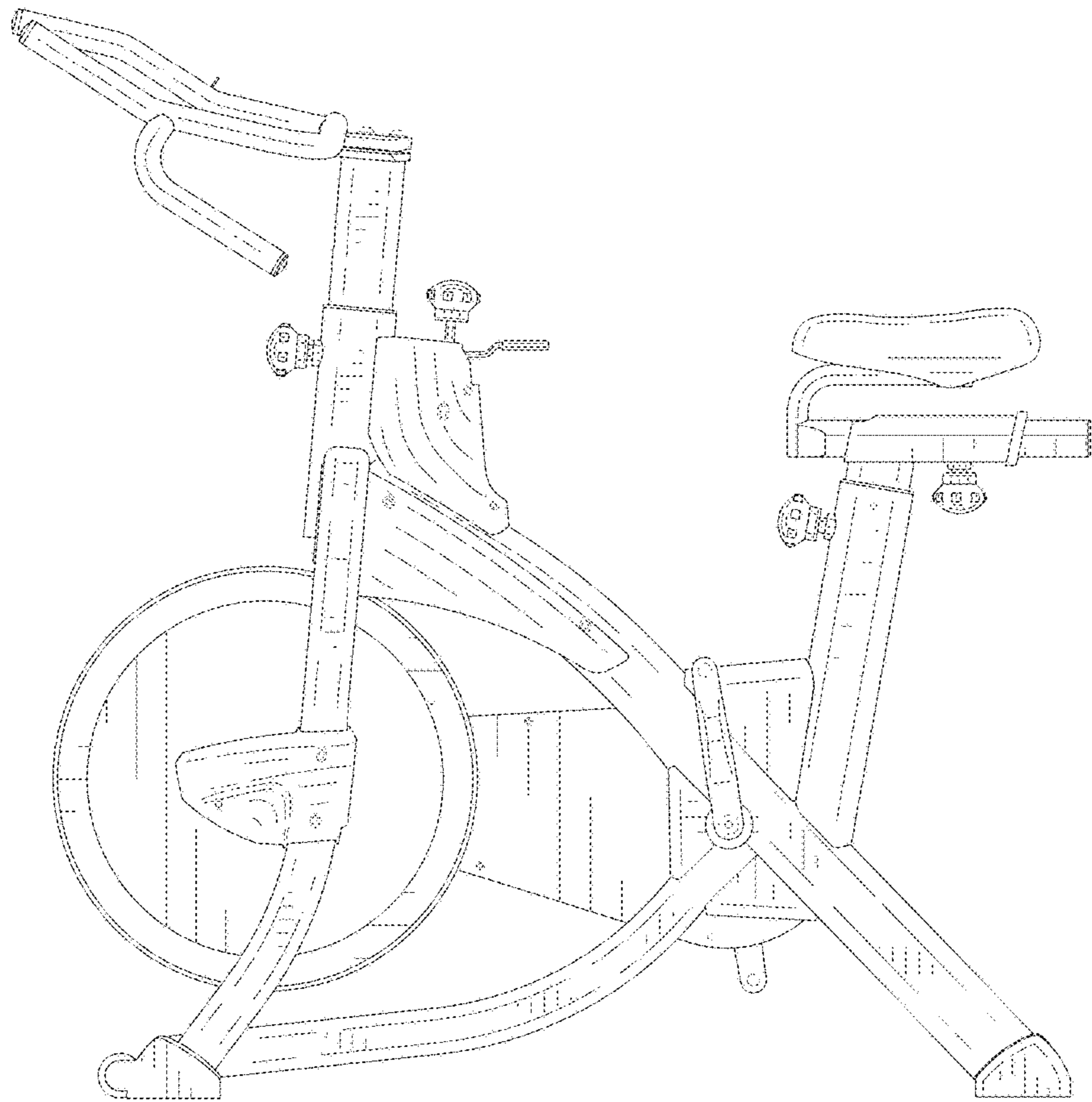

FIG. 2

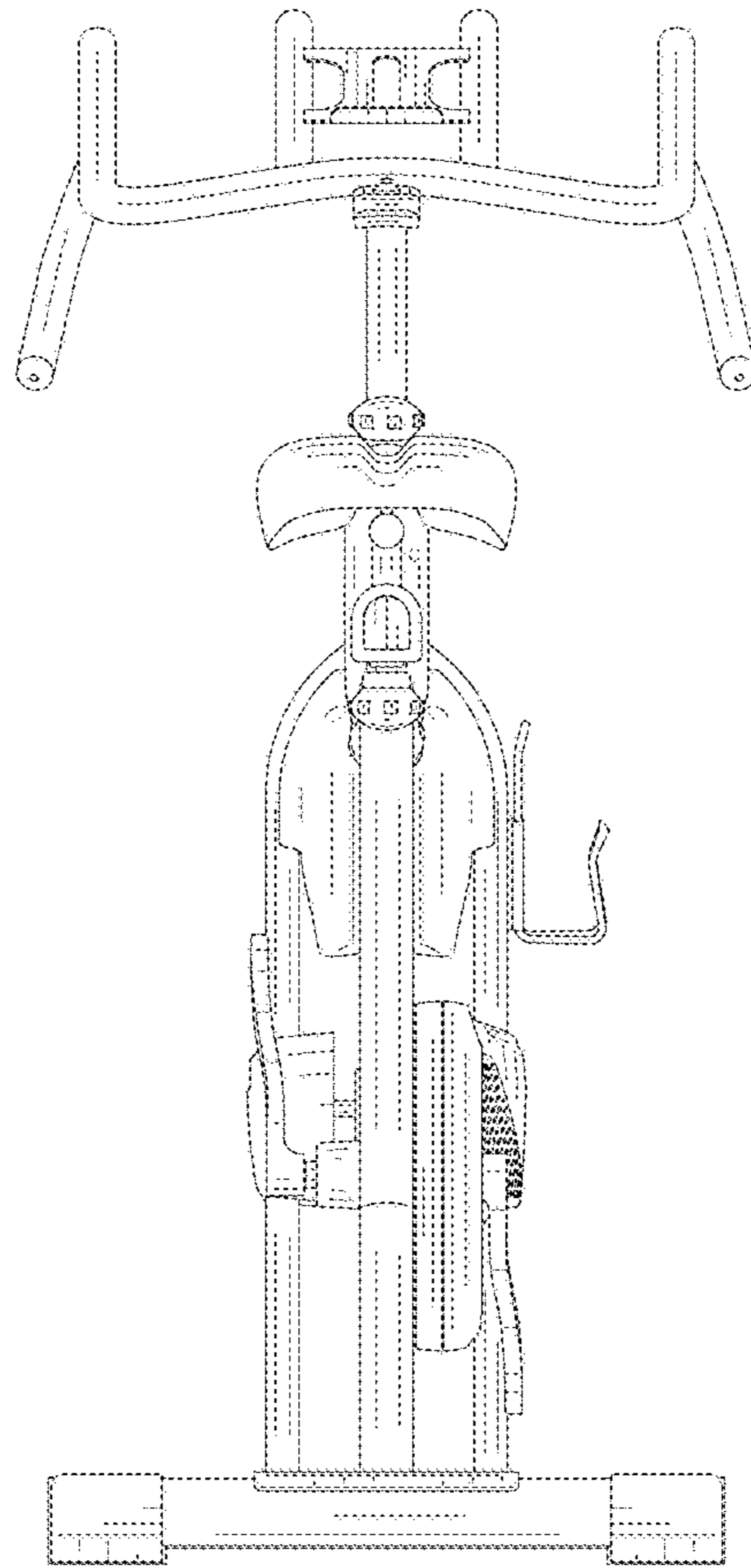

FIG. 3

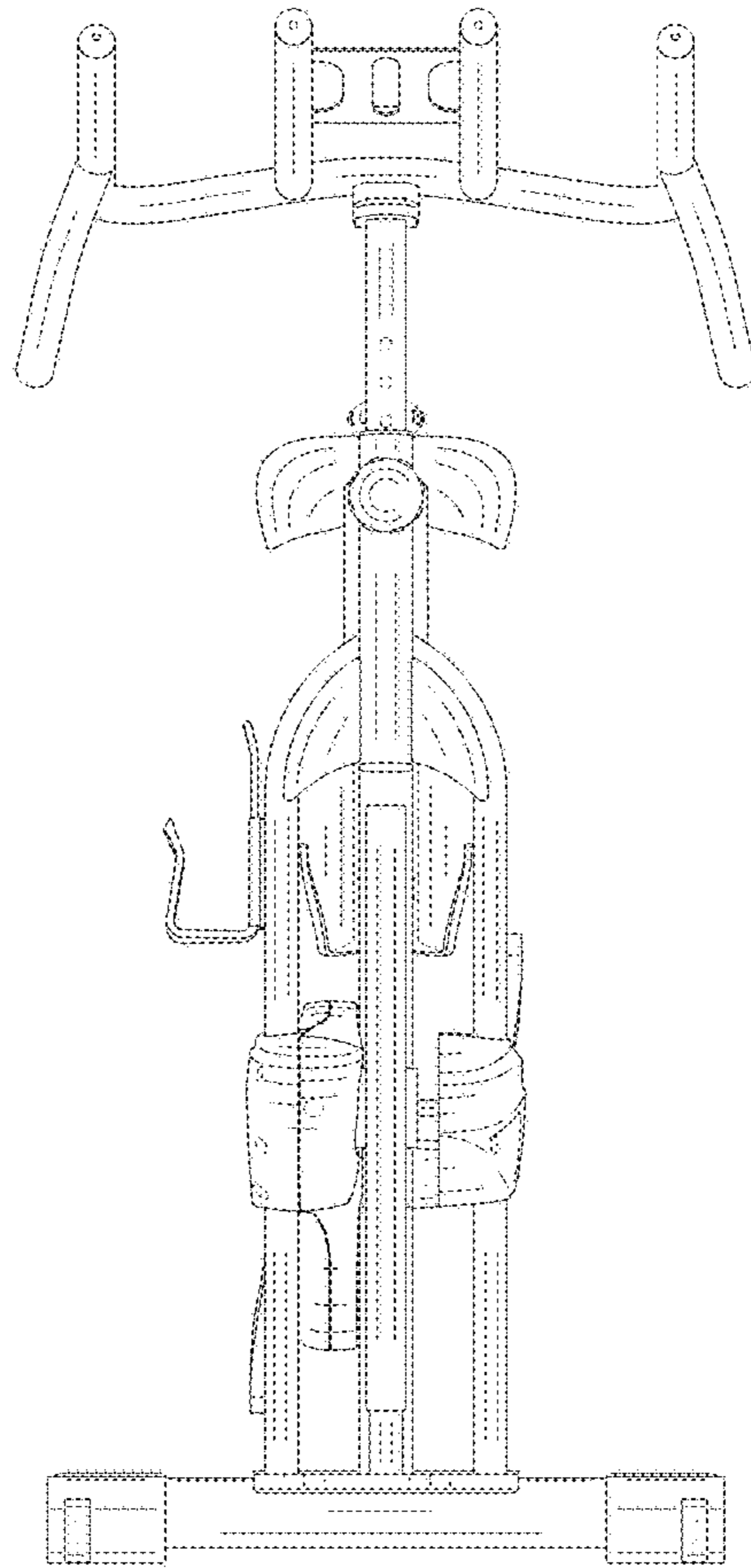

FIG. 4

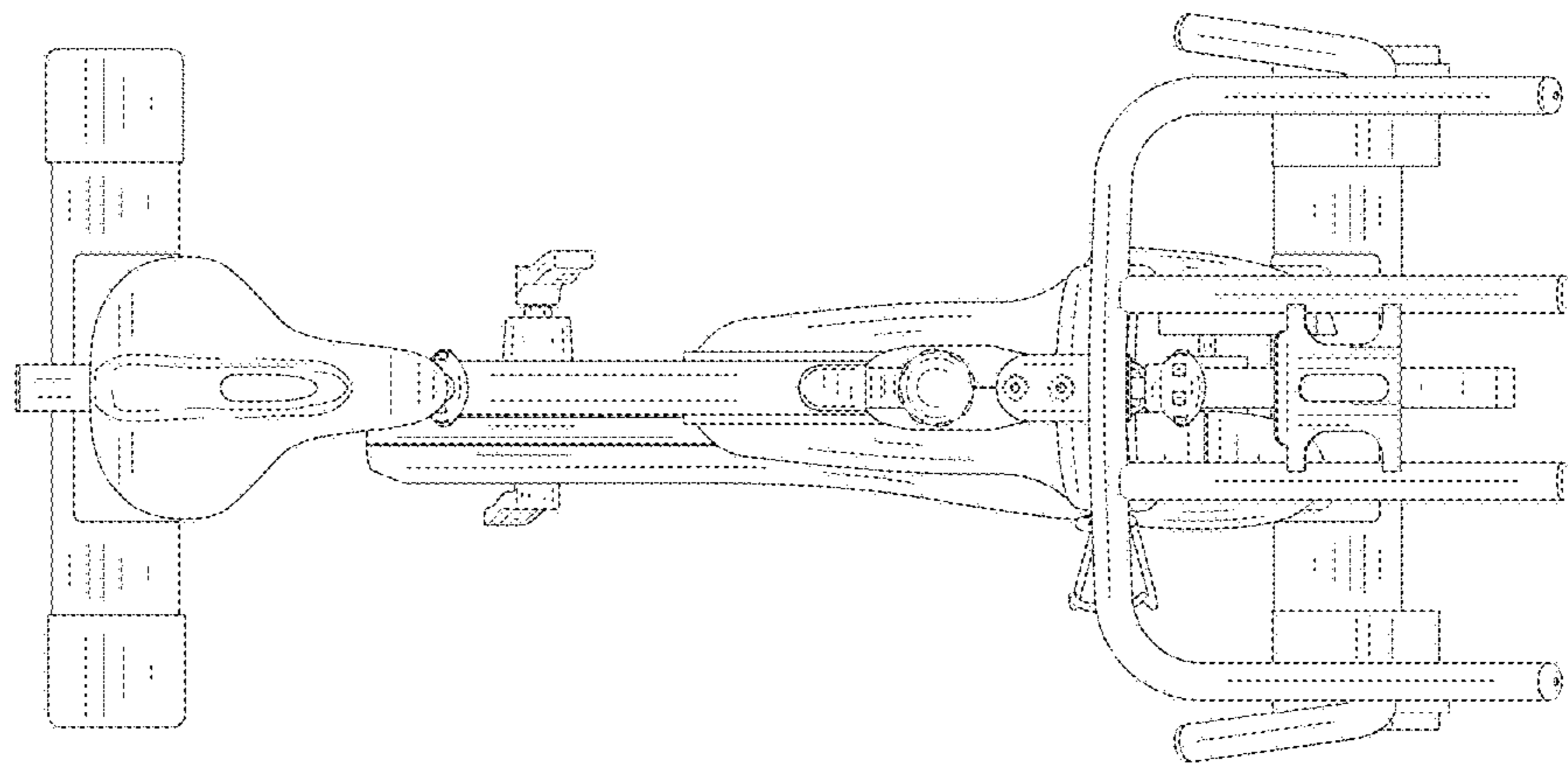

FIG. 5

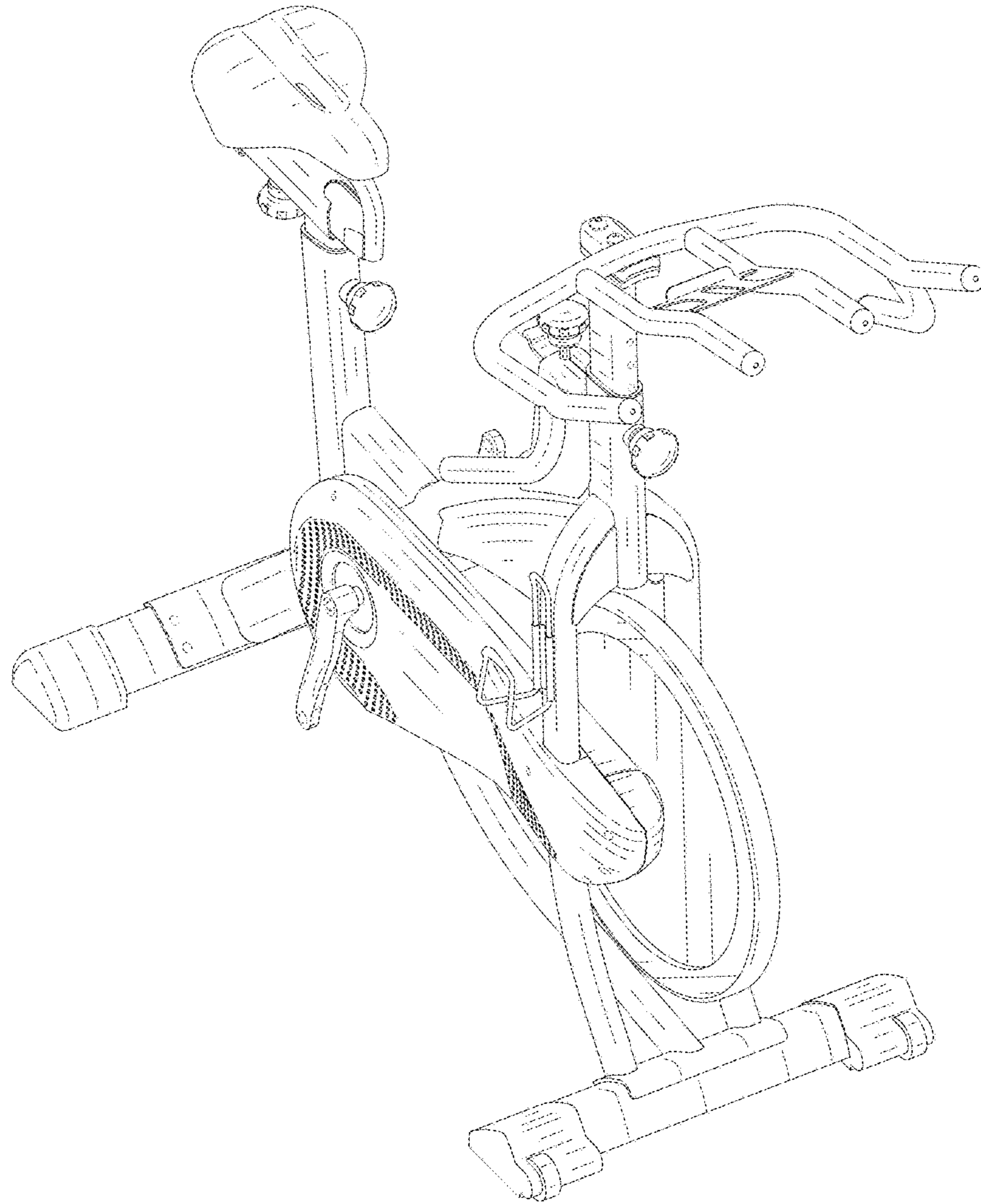

FIG. 6

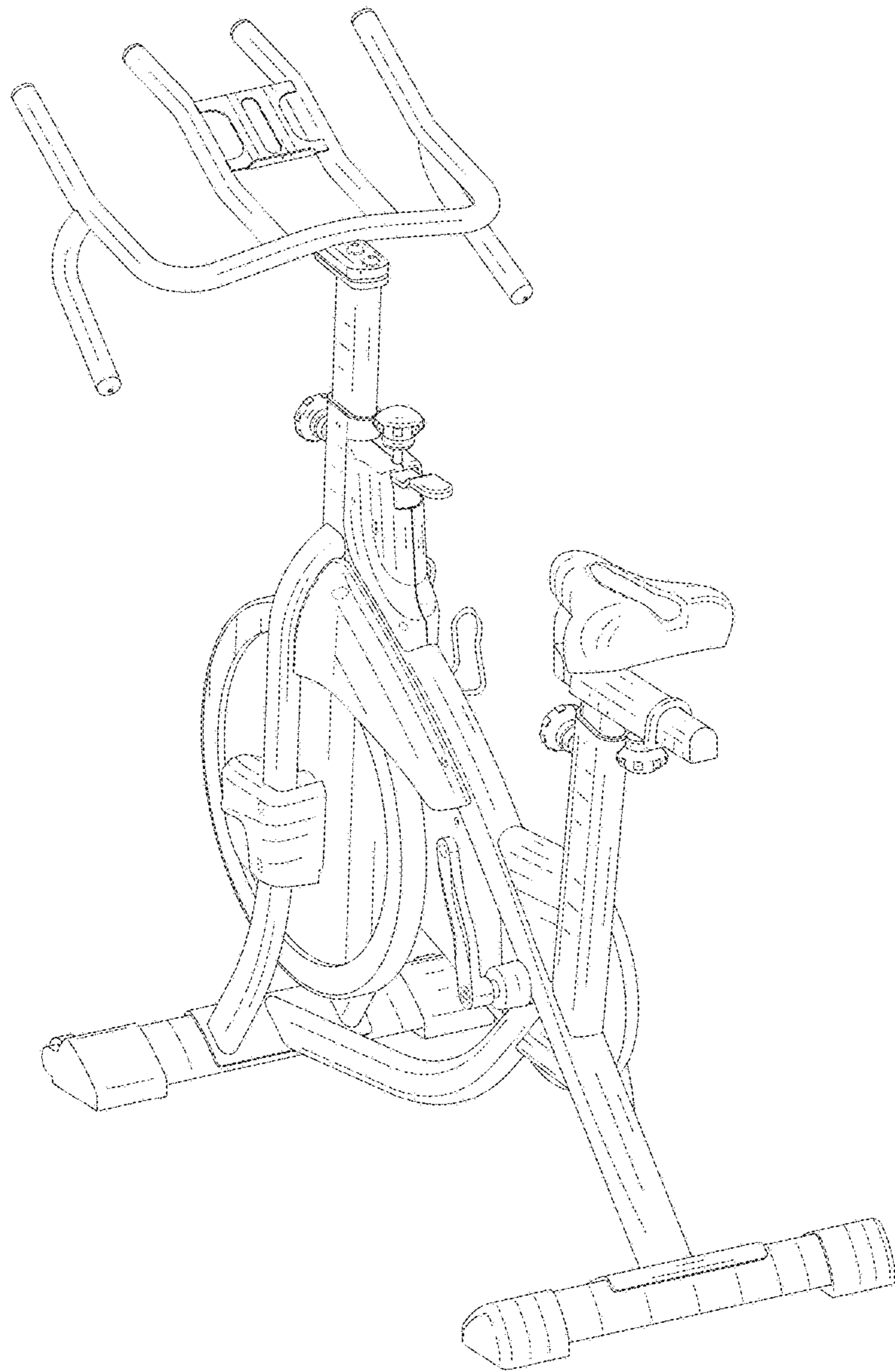

FIG. 7