

US00D860275S

(12) **United States Design Patent** (10) **Patent No.:** **US D860,275 S**
Burton (45) **Date of Patent:** **** Sep. 17, 2019**

(54) **CUTTING TOOL**
(71) Applicant: **US SYNTHETIC CORPORATION**,
Orem, UT (US)
(72) Inventor: **Regan Leland Burton**, Saratoga
Springs, UT (US)
(73) Assignee: **APERGY BMCS ACQUISITION**
CORPORATION, Orem, UT (US)

3,841,708 A 10/1974 Kniff et al.
D238,243 S 12/1975 Polivka
3,958,832 A 5/1976 Sigott et al.
4,006,936 A 2/1977 Crabel
4,083,644 A 4/1978 Friedline et al.
4,140,189 A 2/1979 Garner
4,193,638 A 3/1980 Heckenhauer
4,200,159 A 4/1980 Jurgens et al.
4,299,424 A 11/1981 LeBegue et al.

(Continued)

(**) Term: **15 Years**
(21) Appl. No.: **29/660,512**
(22) Filed: **Aug. 21, 2018**

FOREIGN PATENT DOCUMENTS

AU 2013101370 A4 11/2013
CN 102108866 A 6/2011

(Continued)

OTHER PUBLICATIONS

Final Office Action for U.S. Appl. No. 14/266,437 dated Sep. 18, 2018.

(Continued)

Primary Examiner — Patricia A Palasik
(74) *Attorney, Agent, or Firm* — Dorsey & Whitney LLP

Related U.S. Application Data
(63) Continuation of application No. 29/555,281, filed on Feb. 19, 2016, now Pat. No. Des. 828,859, which is a continuation of application No. 14/273,360, filed on May 8, 2014, now Pat. No. 9,434,091.
(51) **LOC (12) Cl.** **15-09**
(52) **U.S. Cl.**
USPC **D15/139**
(58) **Field of Classification Search**
USPC D8/20, 70, 71; D15/138, 139, 140, 141
CPC B23D 61/06; B28D 1/122; B28D 1/186;
B28D 1/188; E01C 23/088; E01C 23/127;
E21C 35/183; E21C 35/197; E21C
2035/1813; E21C 2035/1816
See application file for complete search history.

(57) **CLAIM**

The ornamental design for a cutting tool, as shown and described.

DESCRIPTION

FIG. 1 is a front, perspective view of a cutting tool;
FIG. 2 is a front elevational view thereof;
FIG. 3 is a back elevational view thereof;
FIG. 4 is a side elevational view thereof, with the other side elevational view being identical;
FIG. 5 is a top plan view thereof; and,
FIG. 6 is a bottom plan view thereof.
The broken lines in the drawings depict unclaimed environmental subject matter.

(56) **References Cited**
U.S. PATENT DOCUMENTS
2,665,893 A 1/1954 Ball
3,342,532 A 9/1967 Krekeler et al.
3,671,075 A 6/1972 Bland et al.
3,695,726 A 10/1972 Krekeler
3,751,114 A 8/1973 Davis
3,785,021 A 1/1974 Norgren et al.

1 Claim, 4 Drawing Sheets

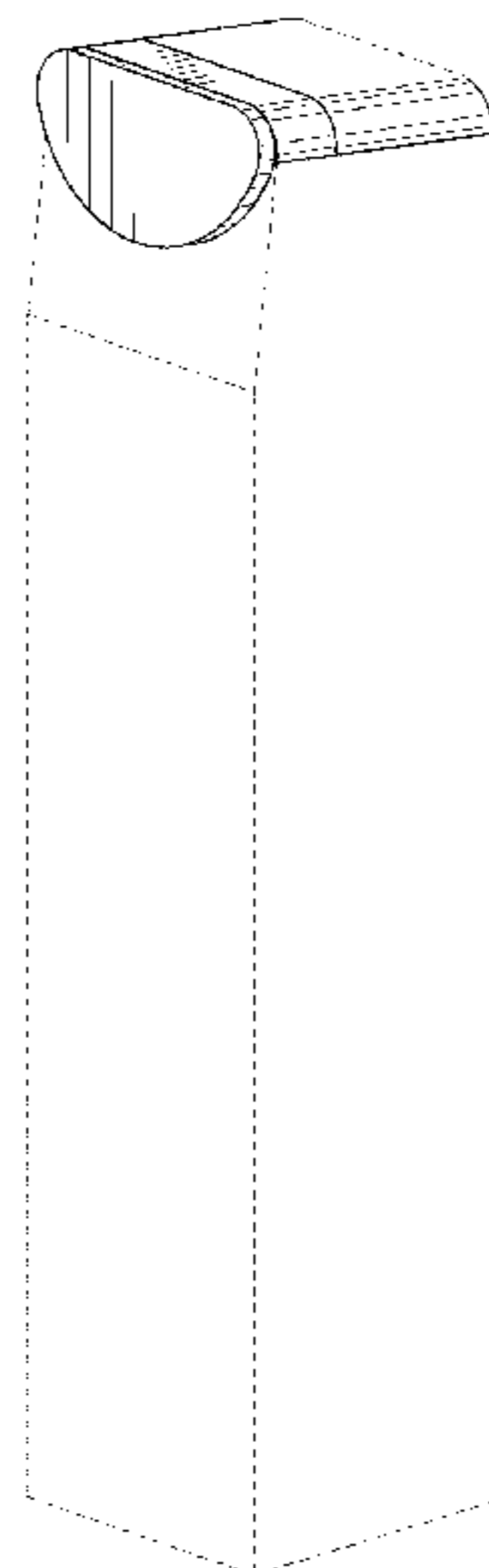

(56)

References Cited

U.S. PATENT DOCUMENTS

4,303,136 A 12/1981 Ball
 4,335,921 A 6/1982 Swisher, Jr. et al.
 4,337,980 A 7/1982 Krekeler
 4,340,325 A 7/1982 Gowanlock et al.
 D270,059 S 8/1983 Wilkins
 D271,497 S 11/1983 Green
 4,484,644 A 11/1984 Cook et al.
 4,580,930 A 4/1986 Zinner et al.
 4,605,343 A 8/1986 Hibbs, Jr. et al.
 4,655,508 A 4/1987 Tomlinson
 4,678,237 A 7/1987 Collin
 4,679,858 A 7/1987 Tank
 D296,107 S 6/1988 Andersson
 4,784,023 A 11/1988 Dennis et al.
 4,787,466 A 11/1988 Tomlinson et al.
 4,836,178 A 6/1989 Tomlinson
 4,850,649 A 7/1989 Beach et al.
 4,880,278 A 11/1989 Tomlinson et al.
 4,902,073 A 2/1990 Tomlinson et al.
 D307,279 S 4/1990 Vincent
 4,913,125 A 4/1990 Bunting et al.
 D311,747 S 10/1990 Mihic
 5,007,685 A 4/1991 Beach et al.
 5,060,739 A 10/1991 Griffin et al.
 5,090,491 A 2/1992 Tibbitts et al.
 5,318,351 A 6/1994 Walker
 5,378,050 A 1/1995 Kammerer et al.
 5,417,475 A 5/1995 Graham et al.
 5,431,239 A 7/1995 Tibbitts et al.
 5,605,382 A 2/1997 Massa et al.
 5,649,604 A 7/1997 Fuller et al.
 5,690,393 A 11/1997 Massa et al.
 5,881,830 A 3/1999 Cooley
 6,089,123 A 7/2000 Chow et al.
 6,213,931 B1 4/2001 Twardowski et al.
 6,283,844 B1 9/2001 Tank
 6,485,104 B1 11/2002 Keller et al.
 6,779,850 B1 8/2004 Schibeci et al.
 7,108,212 B2 9/2006 Latham
 D558,802 S 1/2008 Nicholas
 D616,003 S 5/2010 Ueda et al.
 7,866,418 B2 1/2011 Bertagnolli et al.
 7,998,573 B2 8/2011 Qian et al.
 8,034,136 B2 10/2011 Sani
 8,047,260 B2 11/2011 Uno et al.
 8,079,785 B2 12/2011 Nicholas
 8,236,074 B1 8/2012 Bertagnolli et al.
 D666,640 S 9/2012 Cox et al.
 8,567,533 B2 10/2013 Myers et al.
 8,672,415 B2 5/2014 Neilson et al.
 8,727,044 B2 5/2014 Qian et al.
 8,789,894 B2 7/2014 Claesson et al.
 9,017,438 B1 4/2015 Miess et al.
 9,027,675 B1 5/2015 Jones et al.
 9,028,008 B1 5/2015 Bookhamer et al.
 9,238,893 B2 1/2016 Latham et al.
 9,272,392 B2 3/2016 Mukhopadhyay et al.
 9,272,814 B2 3/2016 Carver et al.
 9,303,511 B2 4/2016 George et al.
 9,382,794 B2 7/2016 Latham et al.
 9,434,091 B2 9/2016 Burton et al.
 9,593,577 B2 3/2017 Lachmann et al.
 D809,031 S * 1/2018 Burton B28D 1/186
 10,018,041 B2 7/2018 Wachsmann et al. D15/139
 2001/0040053 A1 11/2001 Beuershausen et al.
 2002/0153175 A1 10/2002 Ojanen et al.
 2003/0234569 A1 12/2003 Dawood et al.
 2005/0082898 A1 4/2005 Keller et al.
 2006/0033379 A1 2/2006 Frear et al.
 2006/0087169 A1 4/2006 Hesse et al.
 2007/0090679 A1 4/2007 Ojanen et al.
 2008/0030065 A1 2/2008 Frear et al.
 2008/0035383 A1 2/2008 Hall et al.
 2008/0036280 A1 2/2008 Hall et al.

2008/0202819 A1 8/2008 Fader
 2008/0250724 A1 10/2008 Hall et al.
 2008/0309146 A1 12/2008 Hall et al.
 2009/0256413 A1 10/2009 Majagi
 2010/0052406 A1 3/2010 Beach et al.
 2010/0194176 A1 8/2010 Lucek et al.
 2010/0244545 A1 9/2010 Hall et al.
 2010/0326741 A1 12/2010 Patel
 2011/0132667 A1 6/2011 Smallman et al.
 2011/0148178 A1 6/2011 Lehnert et al.
 2011/0233987 A1 9/2011 Maushart et al.
 2011/0266070 A1 11/2011 Scott et al.
 2012/0043138 A1 2/2012 Myers et al.
 2012/0138370 A1 6/2012 Mukhopadhyay
 2012/0160573 A1 6/2012 Myers et al.
 2012/0175939 A1 7/2012 O'Neill et al.
 2012/0279786 A1 11/2012 Cox
 2013/0052481 A1 2/2013 Konyashin
 2013/0092451 A1 4/2013 Mukhopadhyay et al.
 2013/0092452 A1 4/2013 Mukhopadhyay et al.
 2013/0322975 A1 12/2013 Tan et al.
 2014/0110991 A1 4/2014 Sollami
 2014/0175853 A1 6/2014 Warren
 2014/0225418 A1 8/2014 Lachmann et al.
 2014/0240634 A1 8/2014 Matsuzaki
 2014/0339879 A1 11/2014 Burton et al.
 2014/0339883 A1 11/2014 Burton et al.
 2015/0035342 A1 2/2015 Jonker et al.
 2015/0114727 A1 4/2015 Heuser
 2015/0176408 A1 6/2015 Latham
 2015/0176409 A1 6/2015 Latham
 2015/0240635 A1 8/2015 Lachmann et al.
 2015/0314483 A1 11/2015 Miess et al.
 2016/0102550 A1 4/2016 Swope et al.
 2016/0273356 A1 9/2016 Ojanen et al.
 2016/0332269 A1 11/2016 Provins et al.

FOREIGN PATENT DOCUMENTS

CN 202073564 U 12/2011
 CN 203081445 U 7/2013
 GB 1481278 A 7/1977
 GB 2170843 A 8/1986
 GB 2177144 A 1/1987
 GB 2193740 A 2/1988
 WO 2010083015 A1 7/2010
 WO 2012130870 A1 10/2012
 WO 2016071001 A1 5/2016

OTHER PUBLICATIONS

Issue Notification for U.S. Appl. No. 29/555,281 dated Aug. 29, 2018.
 Advisory Action for U.S. Appl. No. 14/266,437 dated Mar. 24, 2017.
 Advisory Action for U.S. Appl. No. 14/275,574 dated Mar. 9, 2017.
 Final Office Action for U. S. Appl. No. 14/273,360 dated Mar. 7, 2016.
 Final Office Action for U.S. Appl. No. 14/266,437 dated Nov. 15, 2017.
 Final Office Action for U.S. Appl. No. 14/811,699 dated Jul. 10, 2018.
 Final Office Action for U.S. Appl. No. 15/238,486 dated Feb. 26, 2018.
 Final Office Action for U.S. Appl. No. 15/266,355 dated Jul. 25, 2018.
 Final Office Action for U.S. Appl. No. 14/266,437 dated Dec. 12, 2016.
 Final Office Action for U.S. Appl. No. 14/275,574 dated Nov. 29, 2016.
 International Search Report and Written Opinion for International Application No. PCT/US2015/027830 dated Jul. 14, 2015.
 International Search Report and Written Opinion from International Application No. PCT/US2014/037381 dated Oct. 30, 2014.
 International Search Report and Written Opinion from International Application No. PCT/US2014/037708 dated Oct. 30, 2014.

(56)

References Cited

OTHER PUBLICATIONS

Issue Notification for U.S. Appl. No. 14/273,360 dated Aug. 17, 2016.

Issue Notification for U.S. Appl. No. 29/540,584 dated Sep. 14, 2017.

Issue Notification for U.S. Appl. No. 29/540,597 dated Sep. 6, 2017.

Issue Notification for U.S. Appl. No. 29/555,279 dated Jan. 10, 2018.

Non-Final Office Action for U.S. Appl. No. 14/266,437 dated Jun. 9, 2016.

Non-Final Office Action for U.S. Appl. No. 14/266,437 dated Apr. 21, 2017.

Non-Final Office Action for U.S. Appl. No. 14/266,437 dated Mar. 28, 2018.

Non-Final Office Action for U.S. Appl. No. 14/273,360 dated Oct. 22, 2015.

Non-Final Office Action for U.S. Appl. No. 14/811,699 dated Nov. 29, 2017.

Non-Final Office Action for U.S. Appl. No. 15/238,486 dated Aug. 17, 2017.

Non-Final Office Action for U.S. Appl. No. 15/266,355 dated Jan. 8, 2018.

Non-Final Office Action for U.S. Appl. No. 14/275,574 dated Apr. 7, 2017.

Non-Final Office for U.S. Appl. No. 29/555,279 dated Mar. 24, 2017.

Non-Final Office Action for U.S. Appl. No. 14/275,574 dated Apr. 6, 2016.

Notice of Allowance for U.S. Appl. No. 14/273,360 dated May 18, 2016.

Notice of Allowance for U.S. Appl. No. 14/275,574 dated Jan. 24, 2018.

Notice of Allowance for U.S. Appl. No. 14/275,574 dated Jun. 15, 2018.

Notice of Allowance for U.S. Appl. No. 14/275,574 dated Sep. 26, 2017.

Notice of Allowance for U.S. Appl. No. 15/065,258 dated Jun. 15, 2018.

Notice of Allowance for U.S. Appl. No. 15/238,486 dated Jun. 20, 2018.

Notice of Allowance for U.S. Appl. No. 29/540,584 dated May 8, 2017.

Notice of Allowance for U.S. Appl. No. 29/540,597 dated May 8, 2017.

Notice of Allowance for U.S. Appl. No. 29/555,279 dated Aug. 31, 2017.

Notice of Allowance for U.S. Appl. No. 29/555,281 dated Jan. 4, 2018.

Notice of Allowance for U.S. Appl. No. 29/555,281 dated May 16, 2018.

Notice of Allowance for U.S. Appl. No. 29/555,269 dated Apr. 6, 2017.

Notice of Allowance for U.S. Appl. No. 29/555,281 dated Apr. 12, 2017.

Restriction Requirement for U.S. Appl. No. 14/273,360 dated Jun. 12, 2015.

Roepke et al., "Drag Bit Cutting Characteristics Using Sintered Diamond Inserts" Report of Investigations 8802; Bureau of Mines Report of Investigations/ 1983; (1983) 35 pages.

Supplemental Notice of Allowability for U.S. Appl. No. 29/555,279 dated Jan. 2, 2018.

Supplemental Notice of Allowance for U.S. Appl. No. 14/273,360 dated Aug. 10, 2016.

Supplemental Notice of Allowance for U.S. Appl. No. 15/238,486 dated Jun. 27, 2018.

Supplemental Notice of Allowance for U.S. Appl. No. 29/540,584 dated Sep. 7, 2017.

Supplemental Notice of Allowance for U.S. Appl. No. 29/540,597 dated Aug. 25, 2017.

Supplemental Notice of Allowance for U.S. Appl. No. 29/540,597 dated Jun. 1, 2017.

Supplemental Notice of Allowance for U.S. Appl. No. 29/555,269 dated Apr. 28, 2017.

Supplemental Notice of Allowance for U.S. Appl. No. 29/555,281 dated Feb. 9, 2018.

Supplemental Notice of Allowance for U.S. Appl. No. 29/555,281 dated Jun. 12, 2017.

Supplemental Notice of Allowance for U.S. Appl. No. 29/555,281 dated Jun. 4, 2018.

U.S. Appl. No. 12/961,787, filed Dec. 7, 2010.

U.S. Appl. No. 13/027,954, filed Feb. 15, 2011.

U.S. Appl. No. 13/070,636, filed Mar. 24, 2011.

U.S. Appl. No. 13/100,388, filed May 4, 2011.

U.S. Appl. No. 13/275,372, filed Oct. 18, 2011.

U.S. Appl. No. 13/648,913, filed Oct. 10, 2012.

U.S. Appl. No. 13/765,027, filed Feb. 12, 2013.

U.S. Appl. No. 13/795,027, filed Mar. 12, 2013.

U.S. Appl. No. 14/266,437, filed Apr. 30, 2014.

U.S. Appl. No. 14/273,360, filed Mar. 7, 2016.

U.S. Appl. No. 14/273,360, filed May 8, 2014.

U.S. Appl. No. 14/275,574, filed May 12, 2014.

U.S. Appl. No. 14/811,699, filed Jul. 28, 2015.

U.S. Appl. No. 15/238,486, filed Aug. 16, 2016.

U.S. Appl. No. 29/540,584, filed Sep. 25, 2015.

U.S. Appl. No. 29/540,597, filed Sep. 25, 2015.

U.S. Appl. No. 29/555,269, filed Feb. 19, 2016.

U.S. Appl. No. 29/555,279, filed Feb. 19, 2016.

U.S. Appl. No. 29/555,281, filed Feb. 19, 2016.

U.S. Appl. No. 61/824,007, filed May 16, 2013.

U.S. Appl. No. 61/824,022, filed May 16, 2013.

U.S. Appl. No. 62/030,525, filed Jul. 29, 2014.

U.S. Appl. No. 62/232,732, filed Sep. 25, 2015.

Advisory Action for U.S. Appl. No. 14/811,699 dated Oct. 22, 2018.

Advisory Action for U.S. Appl. No. 15/266,355 dated Oct. 11, 2018.

Notice of Allowance for U.S. Appl. No. 14/275,574 dated Oct. 11, 2018.

Notice of Allowance for U.S. Appl. No. 15/238,486 dated Oct. 10, 2018.

Supplemental Notice of Allowability for U.S. Appl. No. 14/275,574 dated Oct. 31, 2018.

Non-Final Office Action for U.S. Appl. No. 14/266,437 dated Jan. 8, 2019.

Non-Final Office Action for U.S. Appl. No. 14/811,699 dated Jan. 4, 2019.

Non-Final Office Action for U.S. Appl. No. 15/266,355 dated Nov. 29, 2018.

Notice of Allowance for U.S. Appl. No. 14/275,574 dated Feb. 12, 2019.

Notice of Allowance for U.S. Appl. No. 15/238,486 dated Jan. 28, 2019.

* cited by examiner

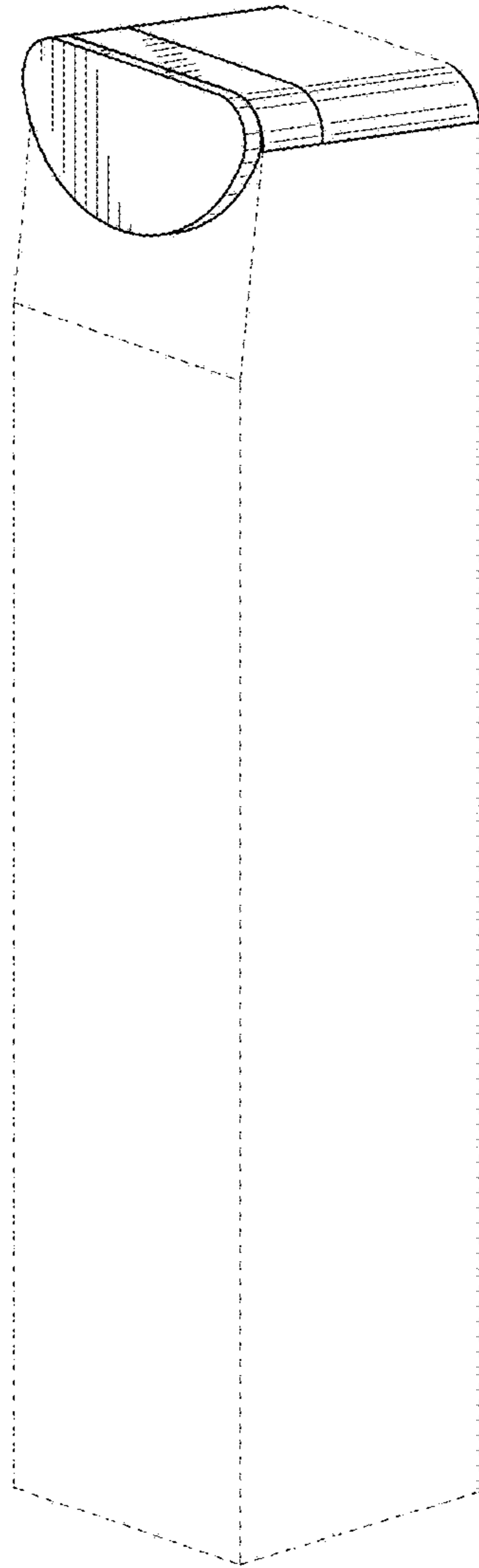

FIG.1

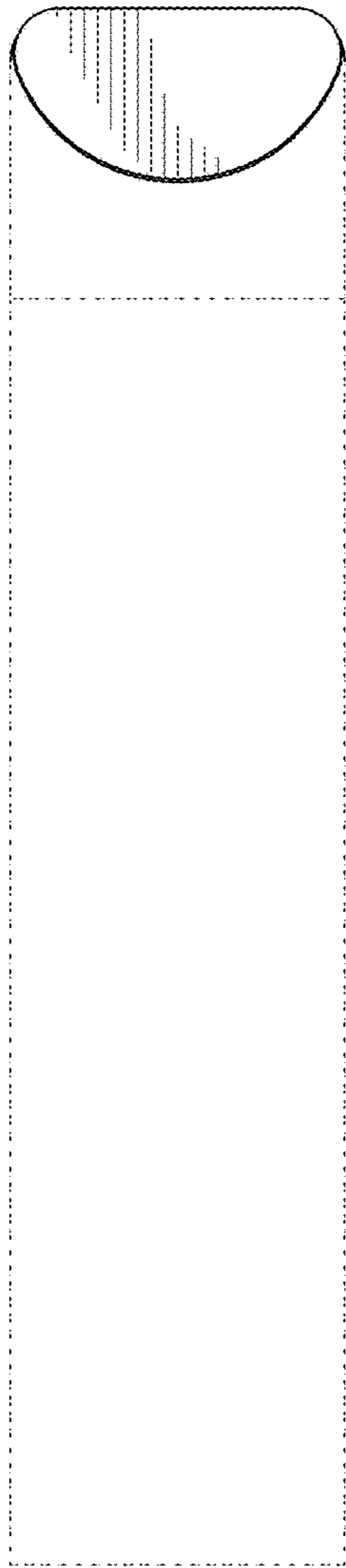

FIG. 2

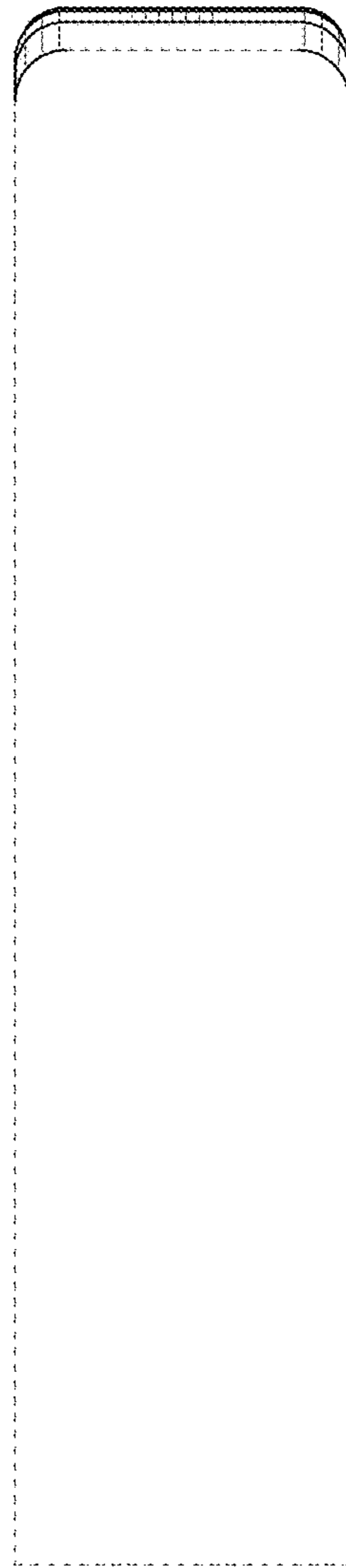

FIG. 3

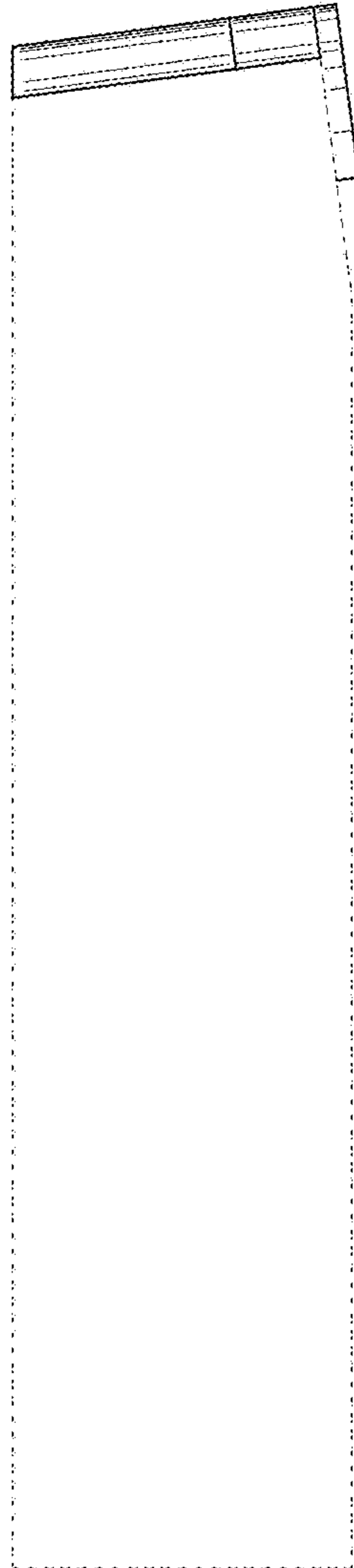

FIG.4

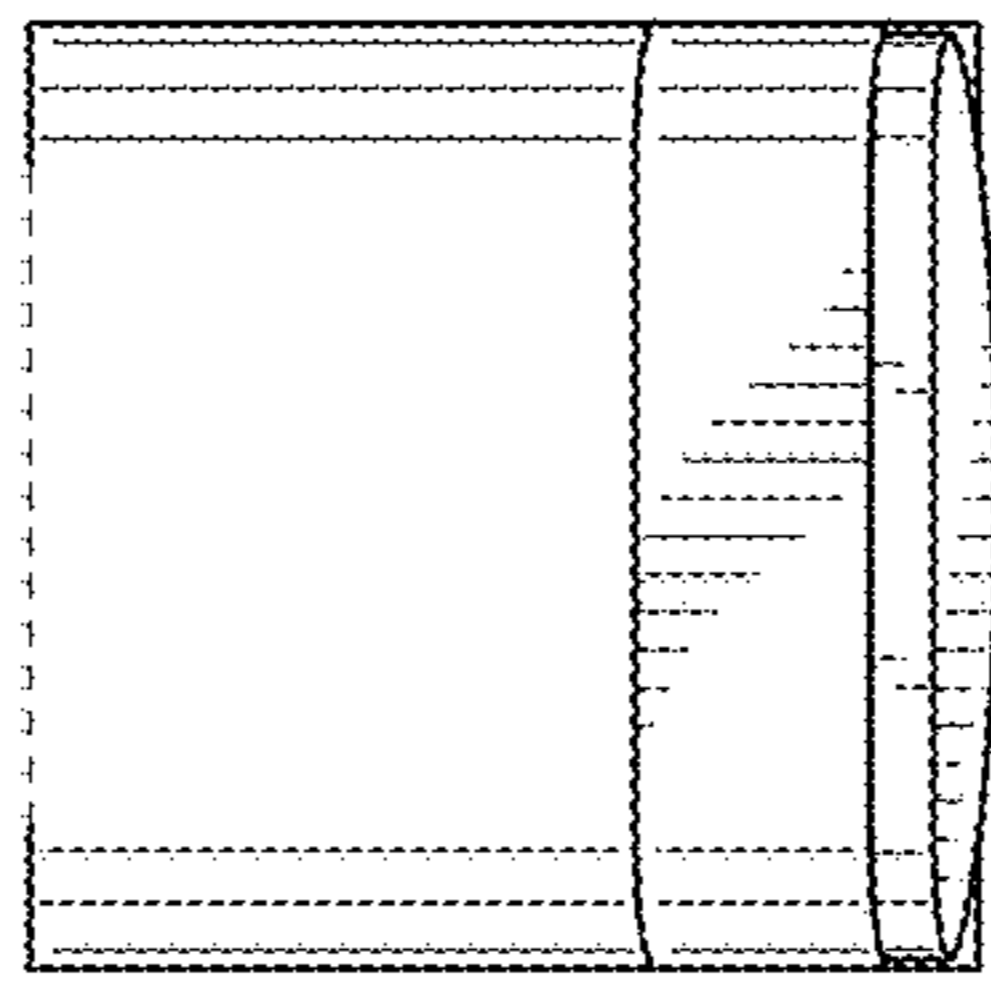

FIG. 5

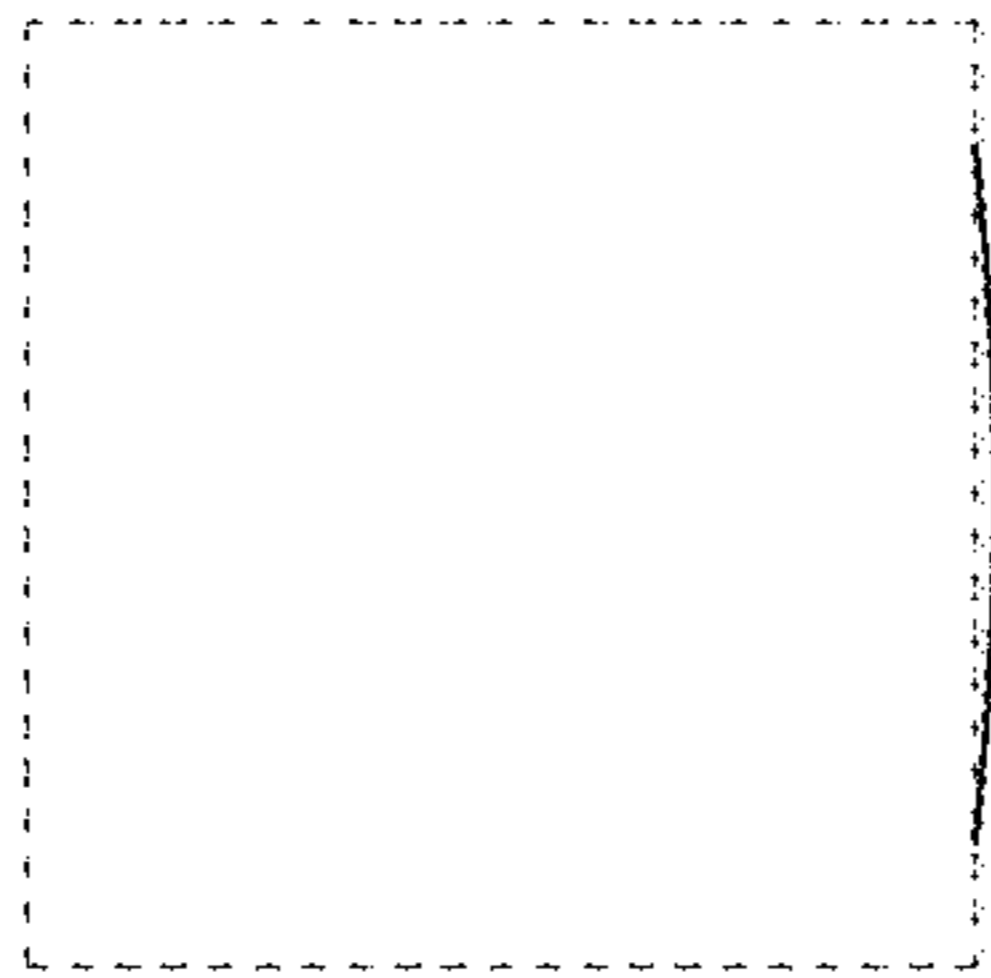

FIG. 6