

US00D860203S

(12) **United States Design Patent**
Chong

(10) **Patent No.:** **US D860,203 S**

(45) **Date of Patent:** **** Sep. 17, 2019**

(54) **MOUSE**

(71) Applicant: **RAZER (ASIA-PACIFIC) PTE. LTD.,**
Singapore (SG)

(72) Inventor: **Boon Sim Chong,** Singapore (SG)

(73) Assignee: **RAZER (ASIA-PACIFIC) PTE. LTD.,**
Singapore (SG)

(**) Term: **15 Years**

(21) Appl. No.: **29/609,228**

(22) Filed: **Jun. 29, 2017**

(51) **LOC (12) Cl.** **14-02**

(52) **U.S. Cl.**
USPC **D14/402**

(58) **Field of Classification Search**
USPC D14/402-411, 356, 388, 389, 383-385,
D14/417, 426; 345/156-167; 463/36-38;
358/471, 473; 273/148 B
CPC G06F 3/03543; G06F 2203/0333; G06F
3/039; G06F 3/038; G06F 2203/0384
See application file for complete search history.

(56) **References Cited**

U.S. PATENT DOCUMENTS

D638,428 S *	5/2011	Kujawski	D14/409
D640,257 S *	6/2011	Lee	D14/410
D665,392 S *	8/2012	Jost	D14/409
D667,409 S *	9/2012	Kujawski	D14/409
D688,245 S *	8/2013	Guerra	D14/409

D739,406 S *	9/2015	Jost	D14/409
9,128,539 B2 *	9/2015	Ng	G06F 3/03543
D745,870 S *	12/2015	Jost	D14/409
D762,646 S *	8/2016	Chong	D14/409
D794,638 S *	8/2017	Zheng	D14/409
D821,400 S *	6/2018	Pang	D14/409
D823,305 S *	7/2018	Ang	D14/409
D825,565 S *	8/2018	Gu	D14/409
D826,939 S *	8/2018	Chong	D14/402
D827,647 S *	9/2018	Chong	D14/402
D830,361 S *	10/2018	Jin	D14/402
D831,650 S *	10/2018	Lu	D14/402
D842,301 S *	3/2019	Chou	D14/410

* cited by examiner

Primary Examiner — Austin Murphy

(74) *Attorney, Agent, or Firm* — Polsinelli PC

(57) **CLAIM**

I claim the ornamental design for a mouse, as shown and described.

DESCRIPTION

FIG. 1 is a perspective view of a mouse, showing my new design;
FIG. 2 is a front elevational view thereof;
FIG. 3 is a rear elevational view thereof;
FIG. 4 is a right side elevational view thereof;
FIG. 5 is a left side elevational view thereof;
FIG. 6 is a top plan view thereof; and,
FIG. 7 is a bottom plan view thereof.
Dashed broken lines are for illustrating portions of the mouse which form no part of the claimed design.

1 Claim, 7 Drawing Sheets

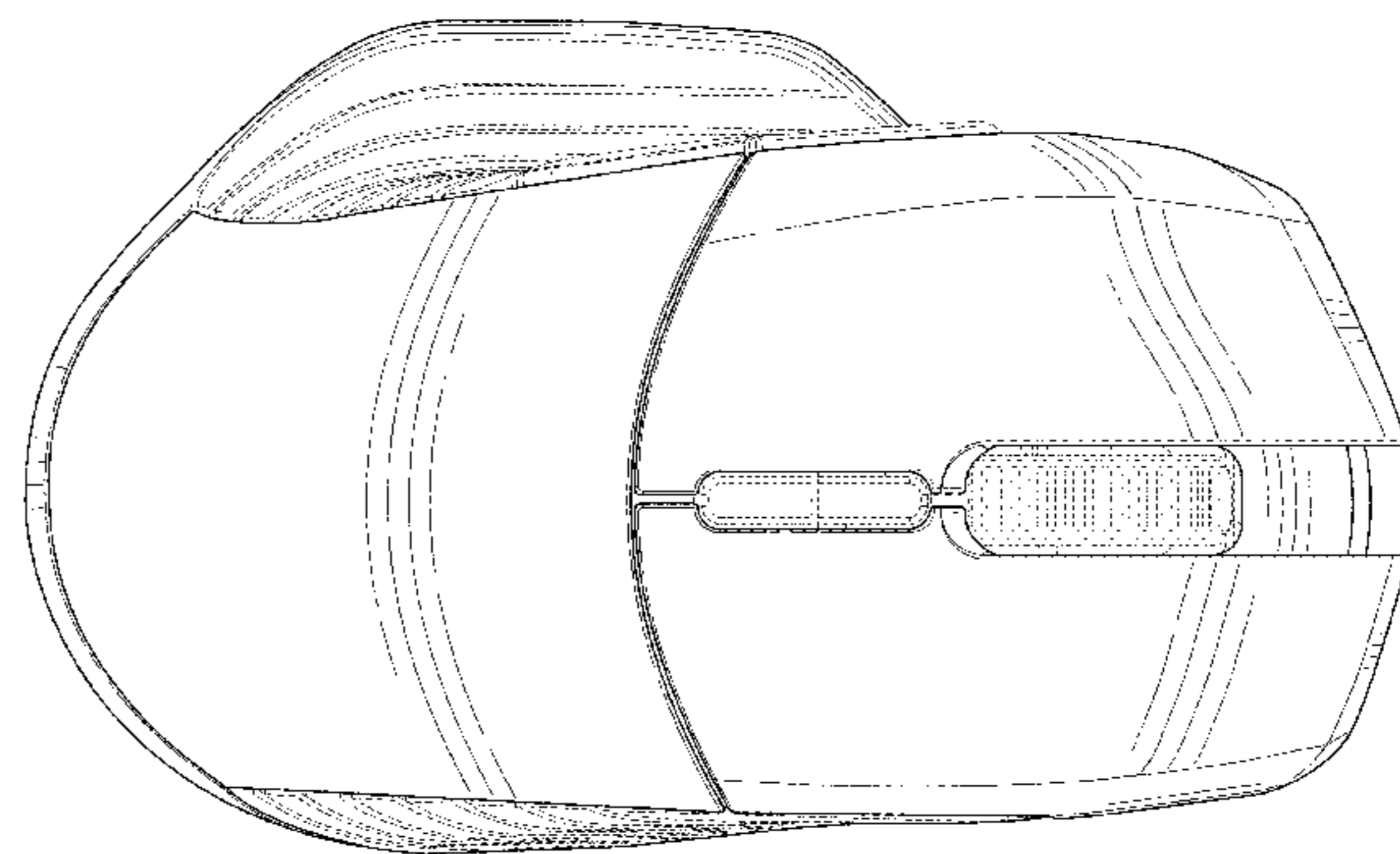
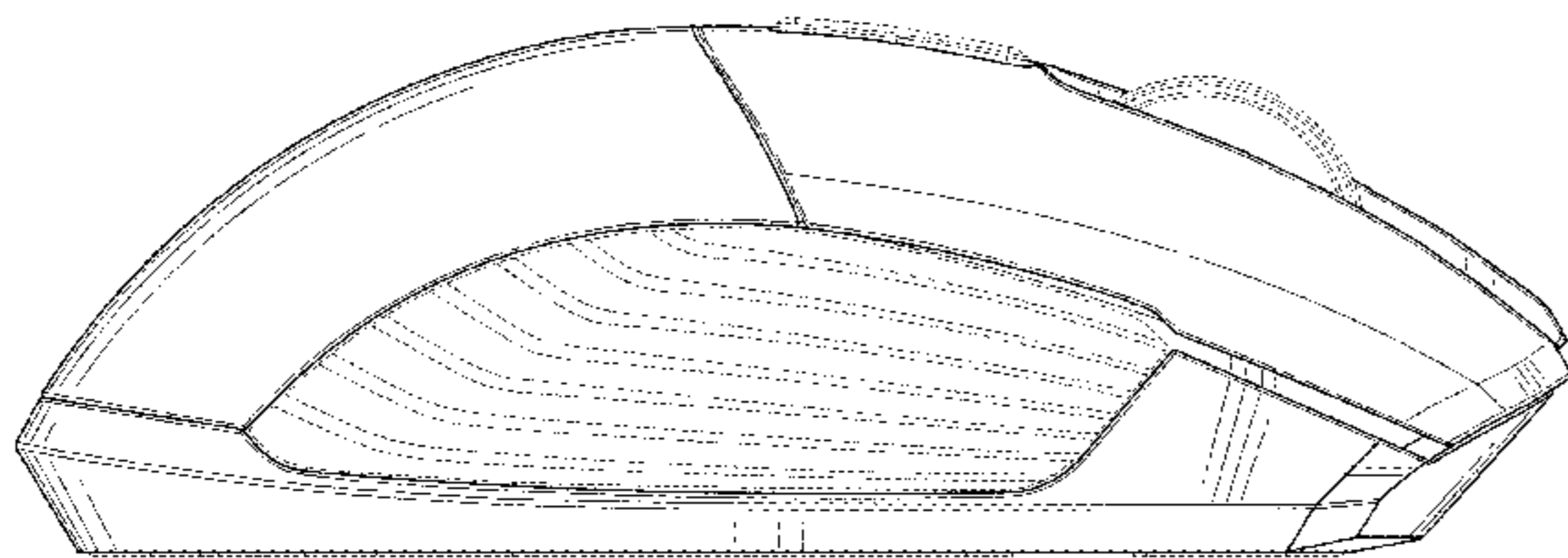

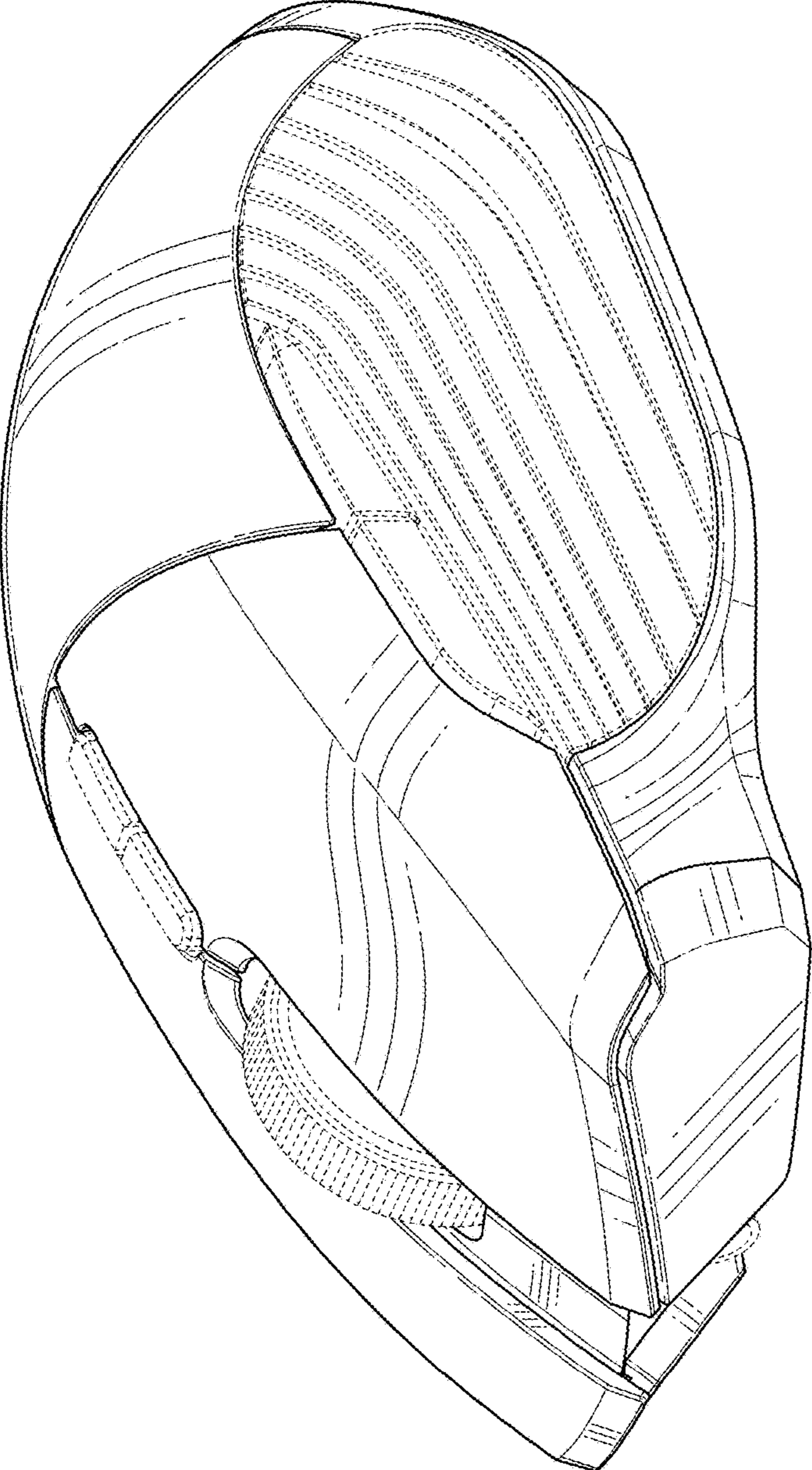

FIG. 1

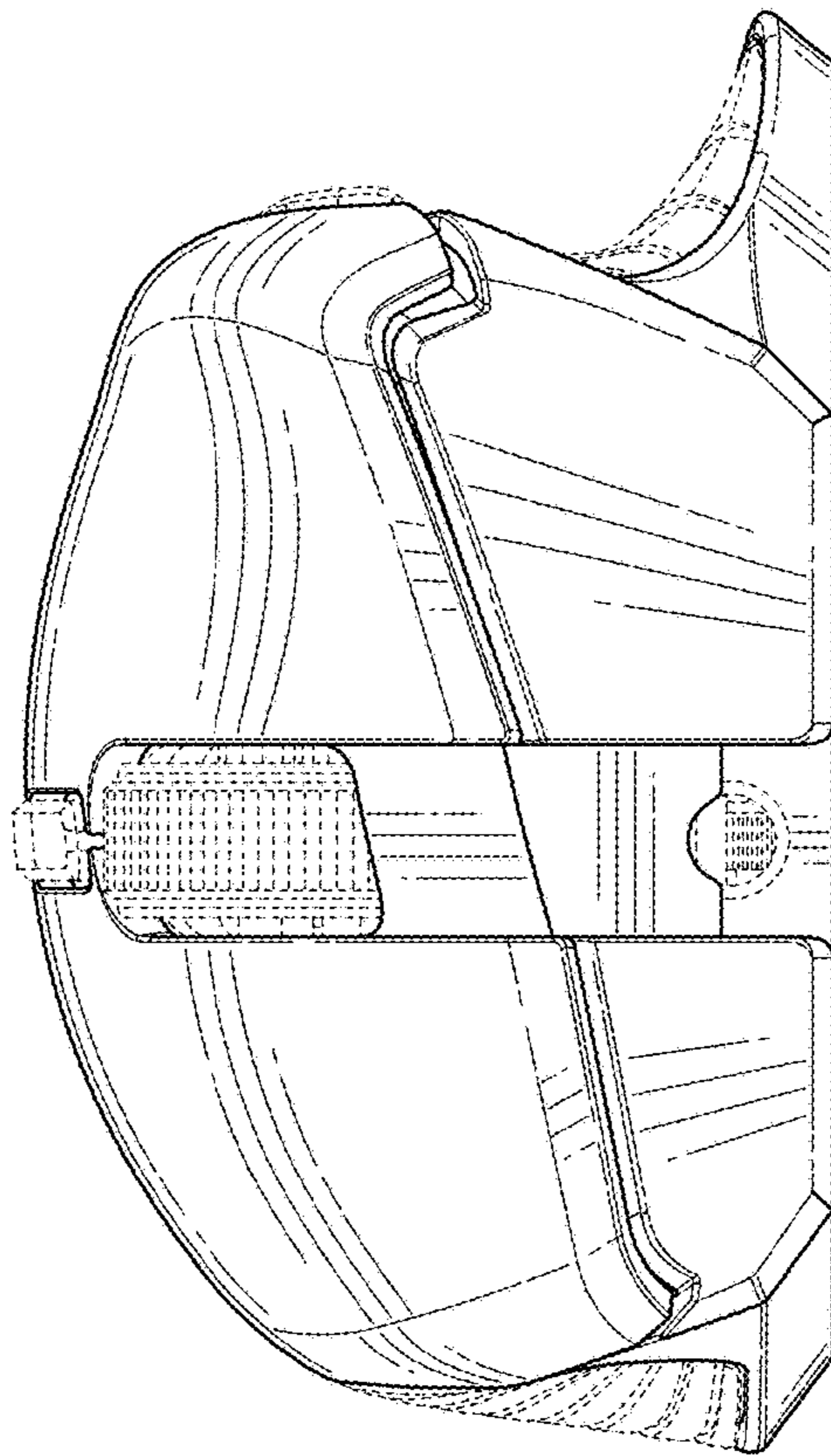

FIG. 2

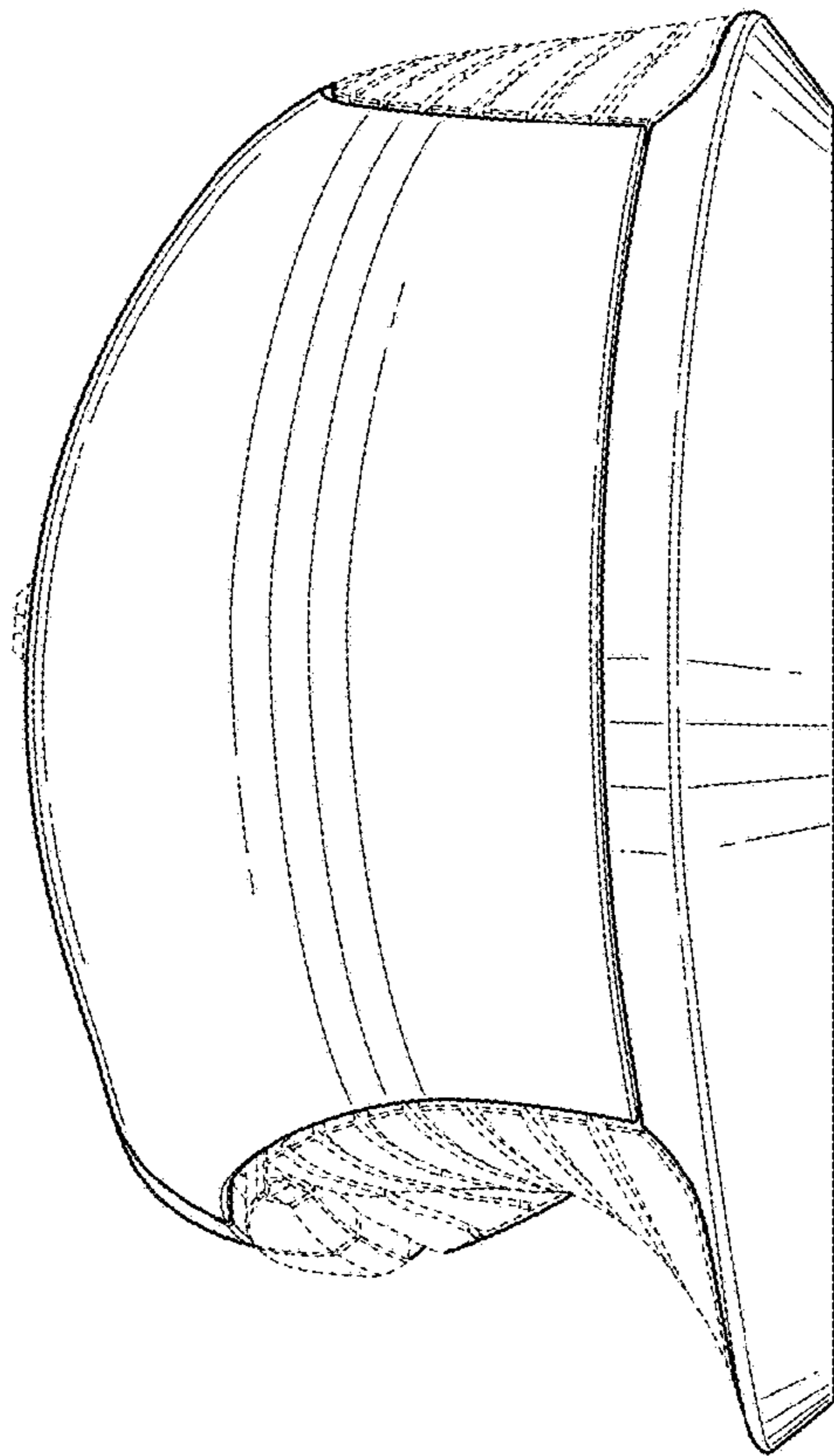

FIG. 3

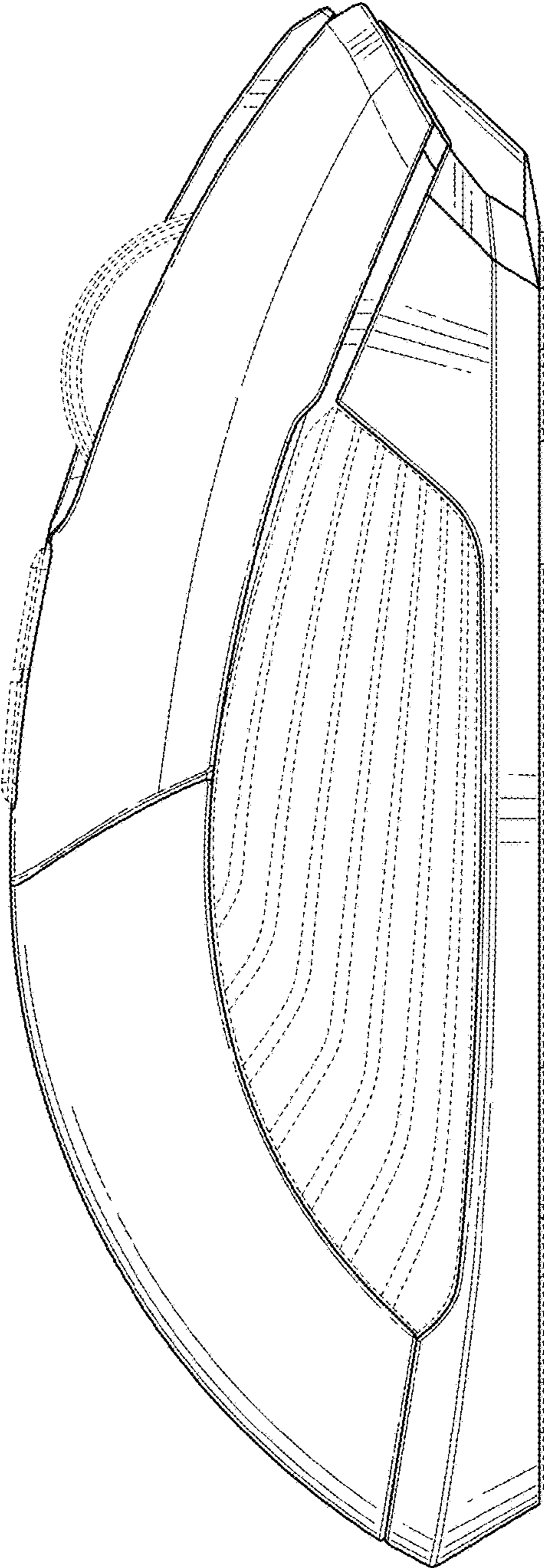

FIG. 4

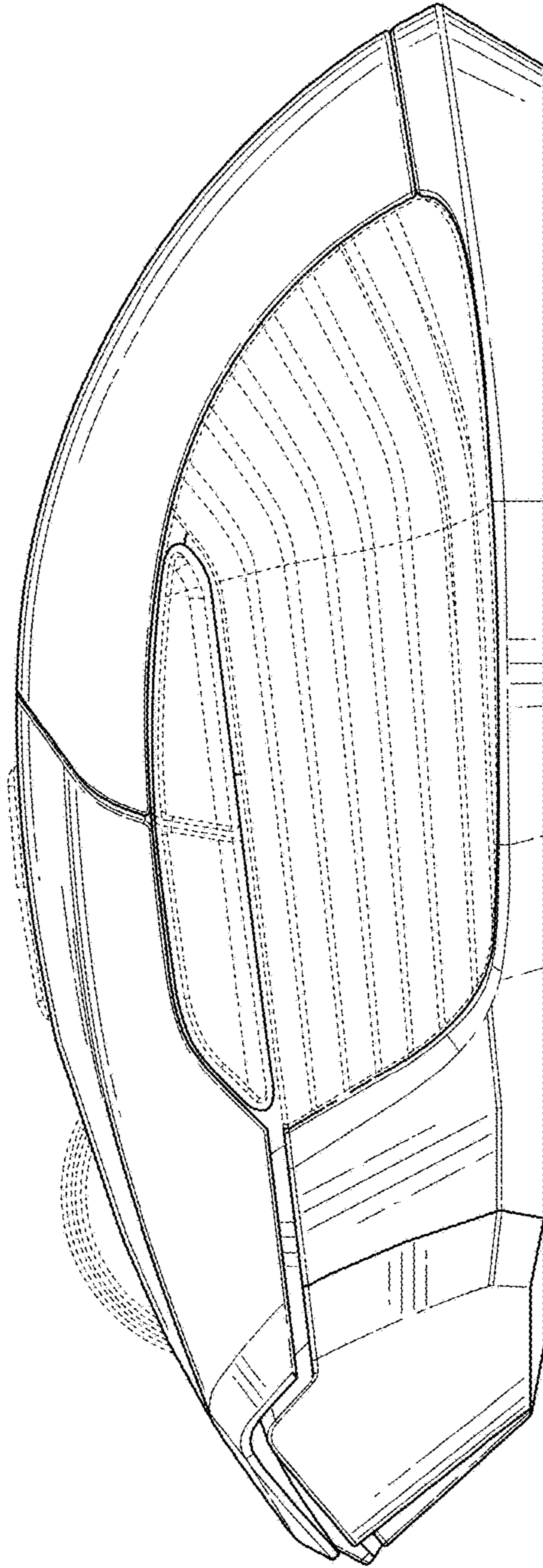

FIG. 5

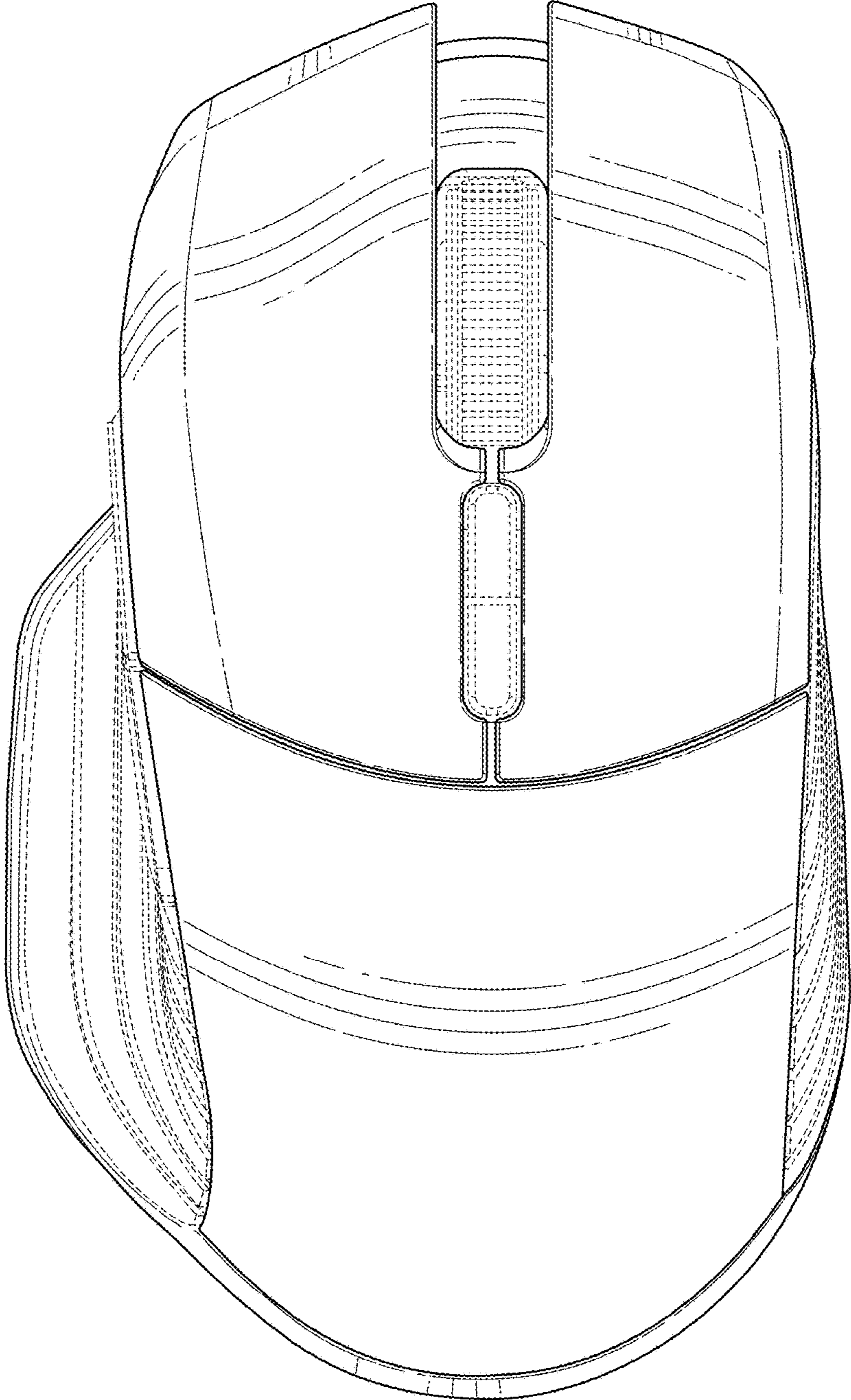

FIG. 6

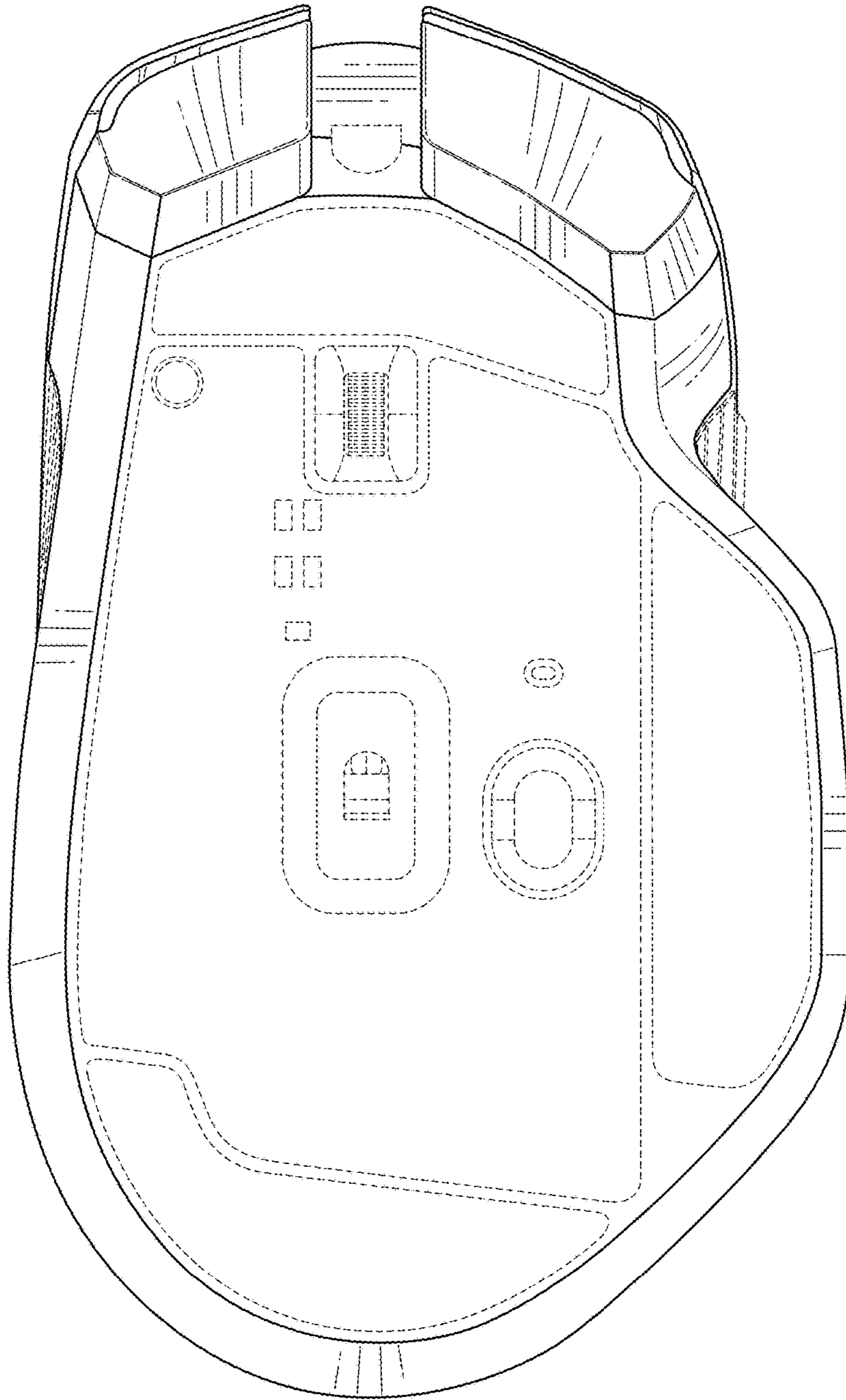

FIG. 7