



US00D860033S

(12) **United States Design Patent**
Quan

(10) **Patent No.:** **US D860,033 S**

(45) **Date of Patent:** **** Sep. 17, 2019**

(54) **WATCH STRAP**

(71) Applicant: **Shenzhen Hong Fei Xing Ye Electronic Technology Co., Ltd.**,
Shenzhen, Guangdong (CN)

(72) Inventor: **Hongfang Quan**, Guangdong (CN)

(73) Assignee: **SHENZHEN HONG FEI XING YE ELECTRONIC TECHNOLOGY CO., LTD.**, Shenzhen (CN)

(**) Term: **15 Years**

(21) Appl. No.: **29/610,830**

(22) Filed: **Jul. 16, 2017**

(51) **LOC (12) Cl.** **11-01**

(52) **U.S. Cl.**
USPC **D11/3**

(58) **Field of Classification Search**
USPC D10/31, 32, 38, 39, 46, 70; D11/1-25,
D11/86, 87; D14/344
CPC A44C 5/12; A44C 5/14; A44C 5/18; A44C
5/0053; A44C 5/0069; A44C 5/0076;
A44C 5/00; A44C 5/0007; A44C 5/0015;
A44C 5/0023; A44C 5/003; A44C
5/0061; A44C 5/147; A44C 5/185; A44C
5/2047; A44C 5/2052; G04B 37/00;
G04B 37/1486; A44B 11/006; A44B
11/24

See application file for complete search history.

(56) **References Cited**

U.S. PATENT DOCUMENTS

D349,257 S *	8/1994	Polenberg	D11/3
D638,736 S *	5/2011	Cobbett	D11/3
D727,198 S *	4/2015	Akana	D11/3
D793,269 S *	8/2017	Magniez	D11/3

D795,121 S *	8/2017	Akana	D11/3
D815,972 S *	4/2018	Akana	D11/3
D821,246 S *	6/2018	Akana	D11/3
D840,860 S *	2/2019	Zhang	D11/3
D841,005 S *	2/2019	Lin	D14/344
2016/0313176 A1 *	10/2016	Lee	G01J 1/429
2018/0000362 A1 *	1/2018	Matsuo	A61B 5/02427

OTHER PUBLICATIONS

Compatible Apple Watch Band (available online Mar. 29, 2017)
Retrieved Feb. 2, 2019 from the internet from URL: <https://www.amazon.com/Compatible-Apple-Alritz-Silicone-Replacement/dp/B06Y66T8C7>.*

* cited by examiner

Primary Examiner — Kevin K Rudzinski

Assistant Examiner — Richard Kearney

(74) *Attorney, Agent, or Firm* — Law Offices of Steven W. Weinrieb

(57) **CLAIM**

The ornamental design for a watch strap, as shown and described.

DESCRIPTION

FIG. 1 is a first perspective view of a watch strap showing my new design;

FIG. 2 is a second perspective view thereof;

FIG. 3 is a front elevational view thereof;

FIG. 4 is a rear elevational view thereof;

FIG. 5 is a left side view thereof;

FIG. 6 is a right side view thereof;

FIG. 7 is a top plan view thereof; and,

FIG. 8 is a bottom plan view thereof.

The broken lines in the drawings depict a dial which form no part of the claimed design.

1 Claim, 8 Drawing Sheets

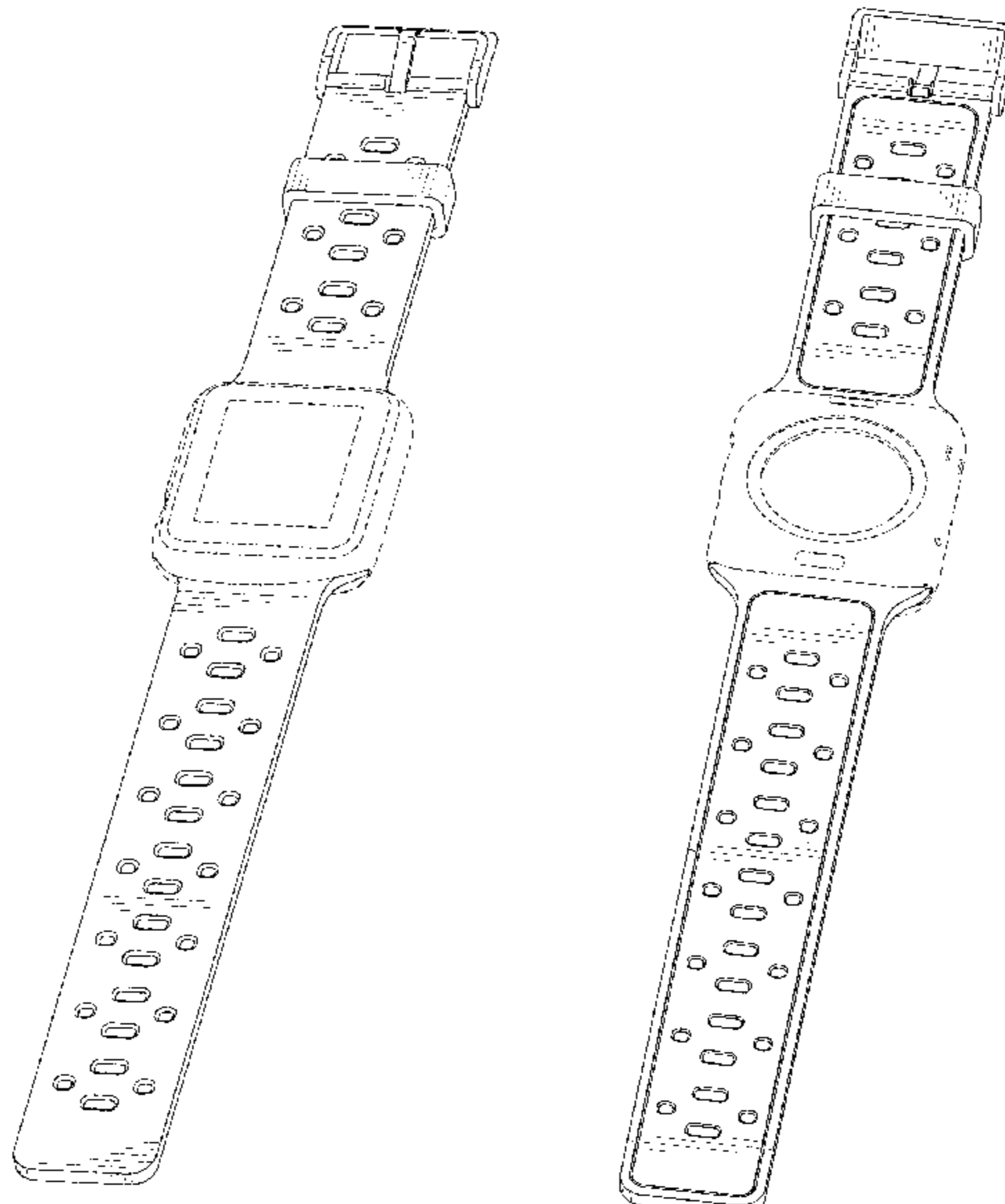

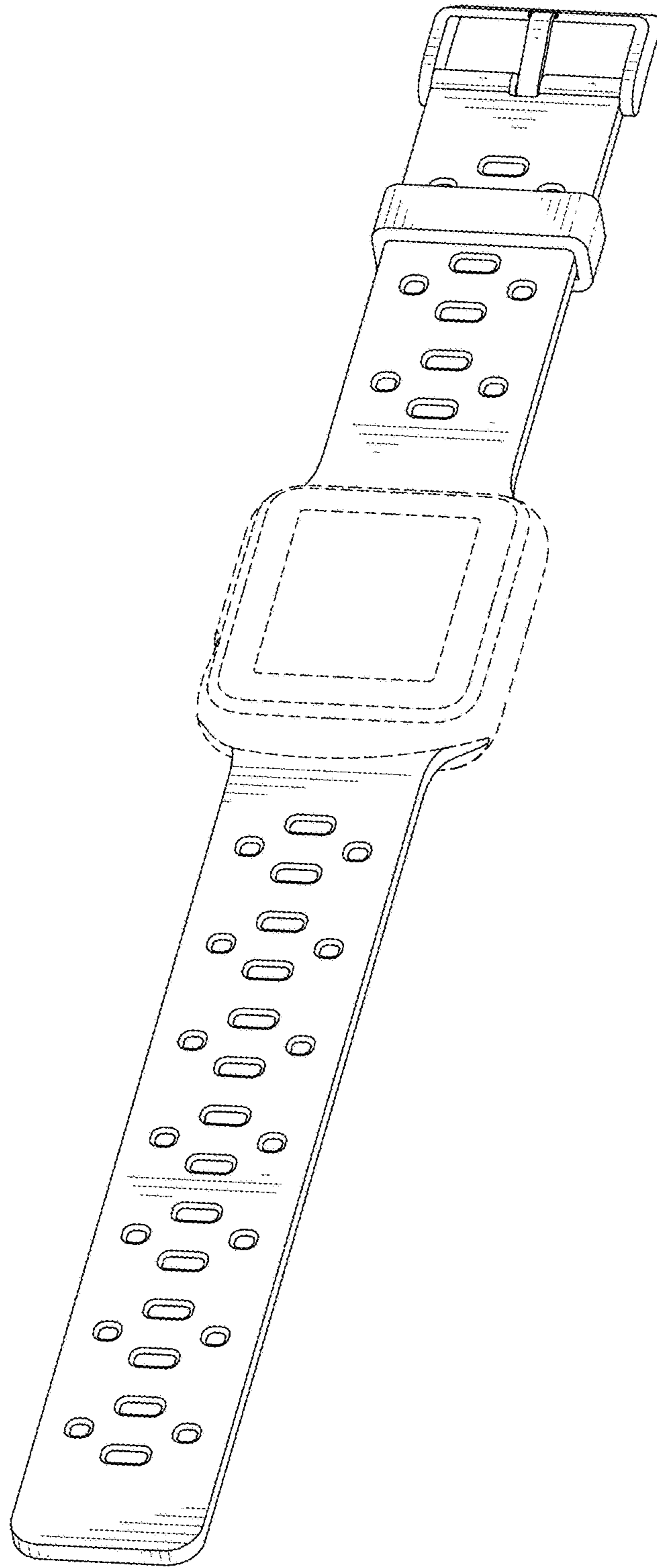

FIG. 1

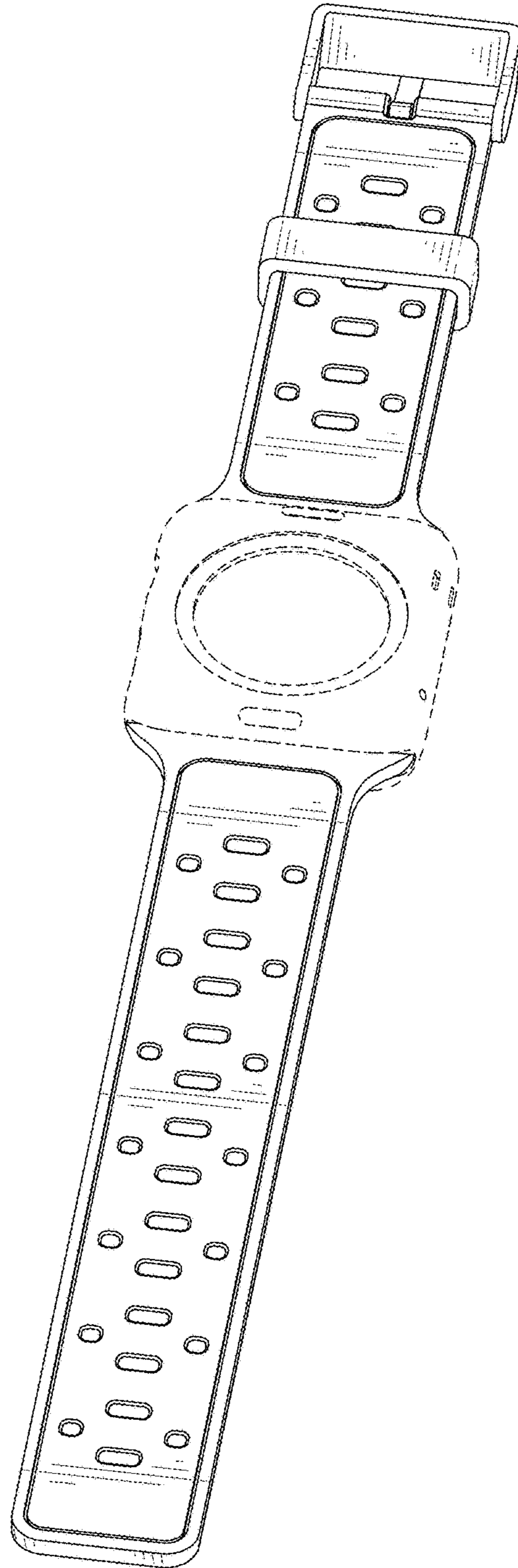

FIG. 2

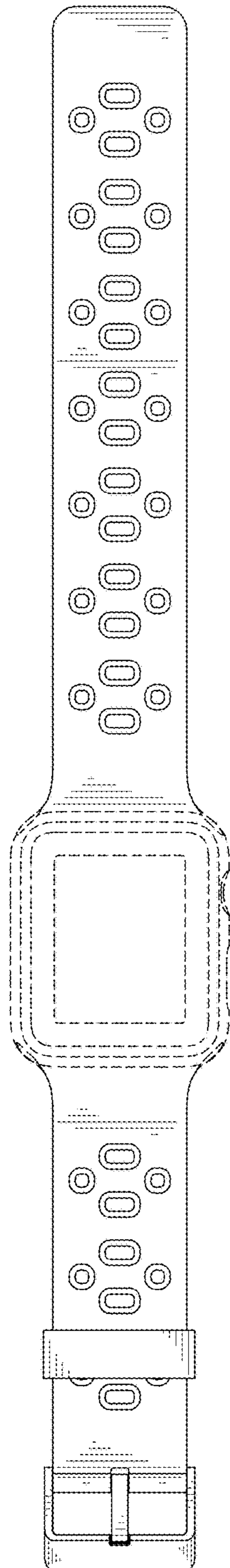

FIG. 3

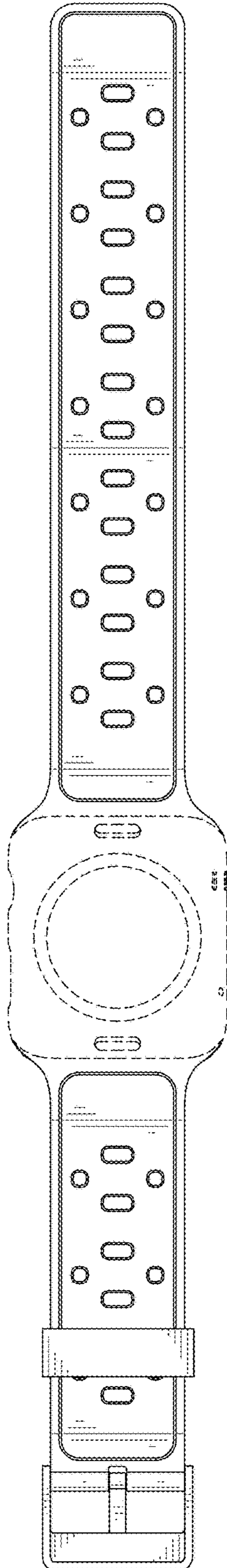

FIG. 4

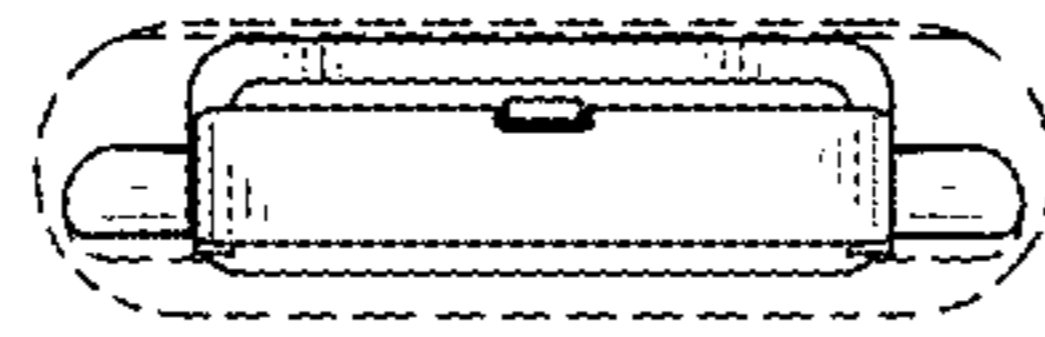

FIG. 5

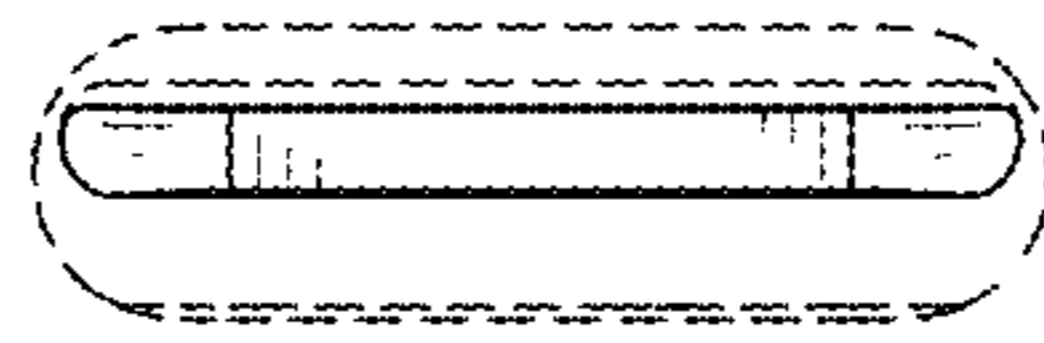

FIG. 6

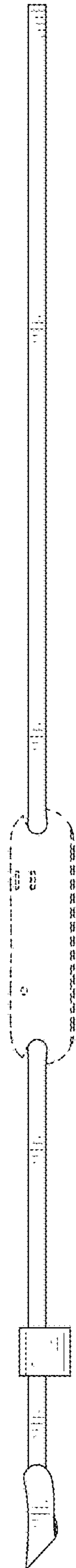

FIG. 7

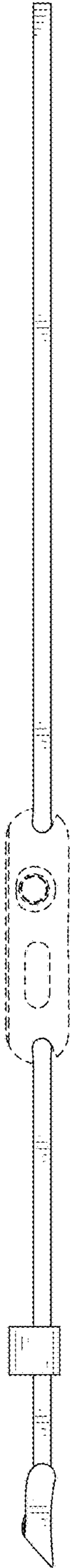

FIG. 8