

US00D86004S

(12) **United States Design Patent** (10) **Patent No.:** **US D860,004 S**  
**Aboabdo** (45) **Date of Patent:** **\*\* Sep. 17, 2019**

(54) **DISPENSING BOTTLE CAP**

- (71) Applicant: **Chubby Gorilla, Inc.**, Santa Fe Springs, CA (US)
- (72) Inventor: **Eyad Aboabdo**, Fullerton, CA (US)
- (73) Assignee: **Chubby Gorilla, Inc.**, Santa Fe Springs, CA (US)

- (\*\*) Term: **15 Years**
- (21) Appl. No.: **29/655,619**
- (22) Filed: **Jul. 5, 2018**

**Related U.S. Application Data**

- (63) Continuation of application No. 29/573,527, filed on Aug. 6, 2016, now Pat. No. Des. 834,950.
- (51) **LOC (12) Cl.** ..... **09-01**
- (52) **U.S. Cl.**  
USPC ..... **D9/724**; D9/558; D9/453
- (58) **Field of Classification Search**  
USPC ..... D9/434, 435, 444-445, 449, 452-454, D9/500-505, 516, 519, 521-526, D9/529-530, 535, 537-546, 548-575, D9/682-694, 723-729; D7/300, 598; 215/379, 381-385; 220/660, 662, 220/669-673, 675  
CPC ..... B65D 1/0223; B65D 2501/0036; B65D 79/005; B65D 23/102; B65D 2501/0027; B65D 23/0284; B65D 1/0233; B65D 1/095;

(Continued)

(56) **References Cited**

**U.S. PATENT DOCUMENTS**

- D199,545 S \* 11/1964 Torongo ..... D24/110
- 3,398,848 A 8/1968 Donovan
- D259,172 S \* 5/1981 Ross ..... D9/529

(Continued)

**OTHER PUBLICATIONS**

Cycles Of Use PET dropper Bottle Unicorn Dropper bottle, posted at amazon.com, posted Jun. 11, 2017, © 1996-2017, Amazon.com [online], [site visited Sep. 20, 2017], Available from Internet, URL:https://www.amazon.com/dropper-Unicorn-Dropper-applicator-dispensor/dp/B071SGRPX/ref=sr\_1\_18\_sspa?ie=UTF8&qid=1505927843&sr-8-18-spons&keywords=chubby+gorilla+unic.

(Continued)

*Primary Examiner* — Barbara Fox  
*Assistant Examiner* — Mary Shannon Malley  
(74) *Attorney, Agent, or Firm* — Knobbe Martens Olson & Bear LLP

(57) **CLAIM**

The ornamental design a dispensing bottle cap, as shown and described.

**DESCRIPTION**

FIG. 1 is a perspective view of a first embodiment of a dispensing bottle cap according to the present invention. FIG. 2 is an elevation view thereof. FIG. 3 is a top plan view thereof. FIG. 4 is a bottom plan view thereof. FIG. 5 is a perspective view of a second embodiment of a dispensing bottle cap according to the present invention. FIG. 6 is an elevation view thereof. FIG. 7 is a top plan view thereof. FIG. 8 is a bottom plan view thereof. FIG. 9 is a perspective view of a third embodiment of a dispensing bottle cap according to the present invention. FIG. 10 is an elevation view thereof. FIG. 11 is a top plan view thereof. FIG. 12 is a bottom plan view thereof. FIG. 13 is a perspective view of a fourth embodiment of a dispensing bottle cap according to the present invention. FIG. 14 is an elevation view thereof. FIG. 15 is a top plan view thereof; and, FIG. 16 is a bottom plan view thereof.

(Continued)

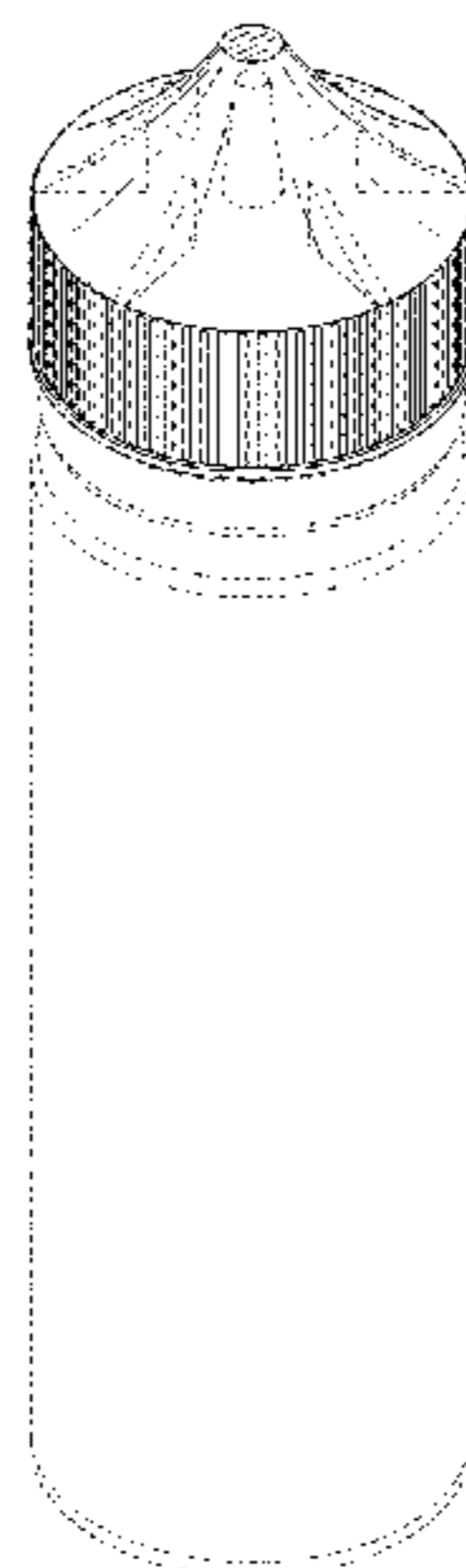

The broken lines show portions of the dispensing bottle cap that form no part of the claimed design.

**1 Claim, 8 Drawing Sheets**

(58) **Field of Classification Search**

CPC ..... B65D 2251/023; B65D 2255/20; B65D 41/0485; B65D 47/122; B65C 3/08  
See application file for complete search history.

(56) **References Cited**

U.S. PATENT DOCUMENTS

D264,938	S	6/1982	Stock	
D264,939	S	6/1982	Stock	
D264,940	S	6/1982	Stock	
D264,941	S	6/1982	Stock	
4,371,088	A	2/1983	Gach	
D277,736	S	2/1985	Long	
D279,080	S	6/1985	Negishi	
4,632,264	A	12/1986	Evans	
4,635,806	A	1/1987	Williamson	
4,705,181	A	11/1987	Burke et al.	
D310,969	S	10/1990	Butler	
5,020,681	A	6/1991	Kusz	
5,115,928	A	5/1992	Drummond, Jr.	
5,314,085	A *	5/1994	Collado Bonet ..	B65D 41/3447 215/252
5,324,481	A	6/1994	Dunn et al.	
D354,914	S	1/1995	Newman	
D356,597	S	3/1995	Gray	
D357,865	S *	5/1995	Hansen .....	D9/453
D362,623	S *	9/1995	Ma .....	D9/443
5,543,115	A	8/1996	Karakawa	
5,676,268	A	10/1997	King	

D411,109	S *	6/1999	Suto .....	D9/550
D412,107	S	7/1999	Bosshardt	
D416,793	S	11/1999	Faughey	
6,202,869	B1	3/2001	Sullivan	
D451,396	S *	12/2001	Johnson .....	D9/530
D491,469	S	6/2004	Horie	
7,334,694	B2	2/2008	Suffa	
D564,357	S *	3/2008	Kapoor .....	D9/503
D603,710	S	11/2009	Wilson et al.	
D651,921	S	1/2012	Probst	
8,633,016	B2	1/2014	Parker	
8,673,242	B2	3/2014	Shick	
D704,052	S	5/2014	Yoshii et al.	
D732,400	S	6/2015	Hua	
D732,975	S *	6/2015	Hua .....	D9/724
9,045,265	B2	6/2015	Adamczak	
D768,506	S	10/2016	Hua	
D826,068	S *	8/2018	Aboabdo .....	D9/724
D834,950	S *	12/2018	Aboabdo .....	D9/724
2003/0211616	A1	11/2003	Leong	
2007/0042454	A1	2/2007	Nix	
2010/0167271	A1 *	7/2010	Ryan .....	G01N 33/56972 435/5
2011/0281342	A1 *	11/2011	Porsch .....	A61B 5/14532 435/287.1
2017/0057710	A1	3/2017	Greiner-Perth et al.	

OTHER PUBLICATIONS

Chubby Gorilla PET Bottles (3-Pack), posted at amazon.com, posted Jan. 31, 2017, © 1996-2017, Amazon.com,[online], [site visited Sep. 20, 2017]. Available from Internet, URL:[https://www.amazon.com/Chubby-Gorilla-Bottles-3-Pack-Transparent/dp/B071HCL64L/ref=pd\\_sbs\\_201\\_1?encoding=UTF8&pd\\_rd\\_i=B071HCL64L&pd\\_rd\\_r=EE8F90ZD7DBQEXF5PEVF&pd\\_rd\\_w=oITEN&pd\\_rd\\_wg=ko](https://www.amazon.com/Chubby-Gorilla-Bottles-3-Pack-Transparent/dp/B071HCL64L/ref=pd_sbs_201_1?encoding=UTF8&pd_rd_i=B071HCL64L&pd_rd_r=EE8F90ZD7DBQEXF5PEVF&pd_rd_w=oITEN&pd_rd_wg=ko).

\* cited by examiner

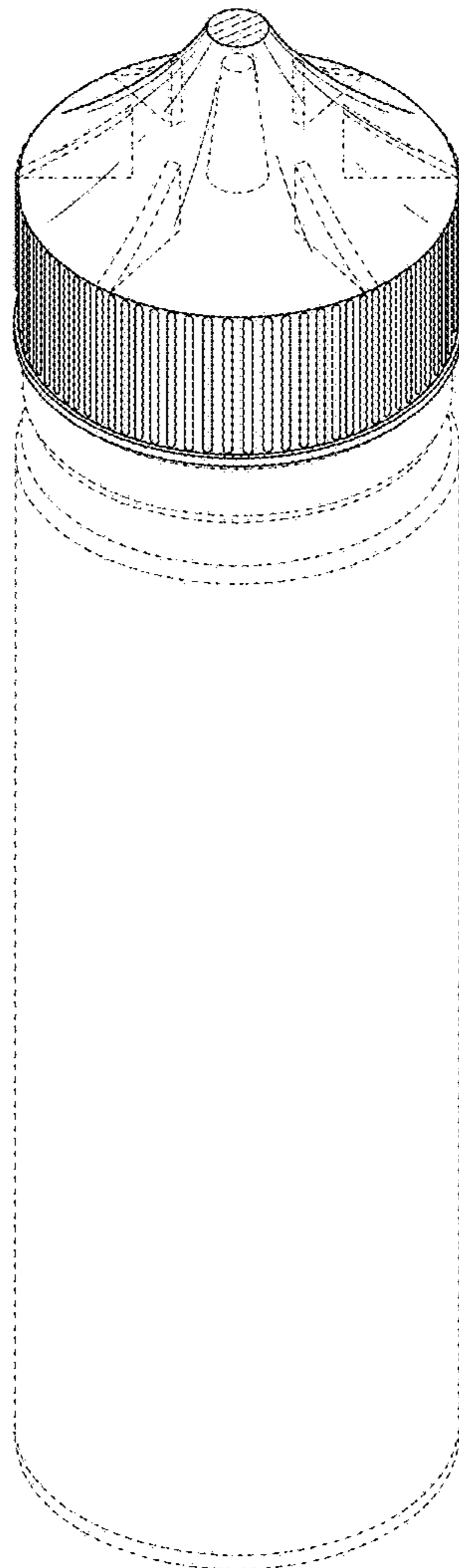

FIG. 1

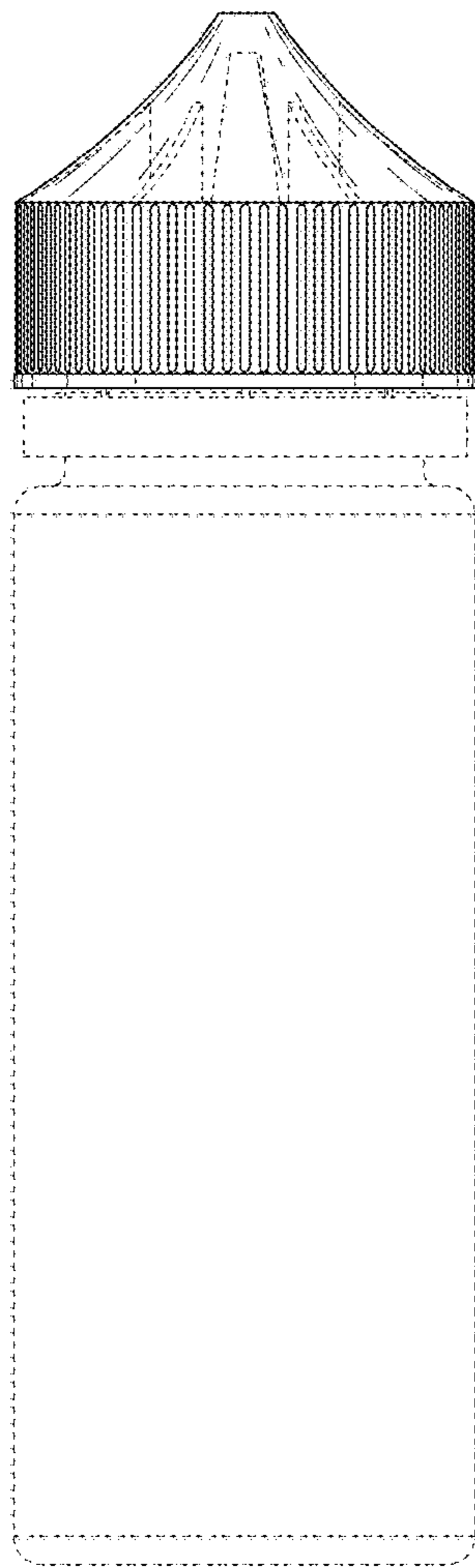

FIG. 2

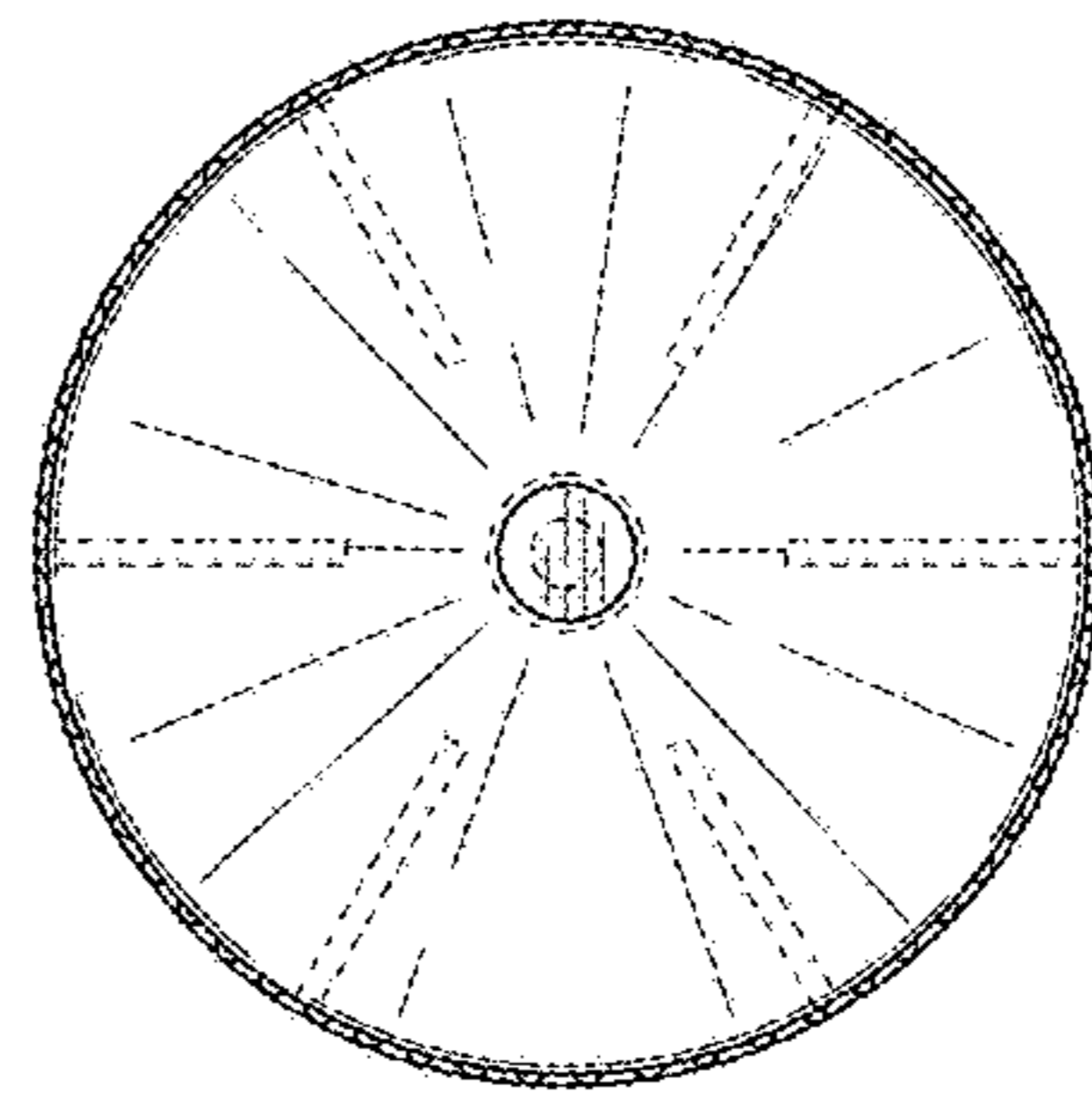

FIG. 3

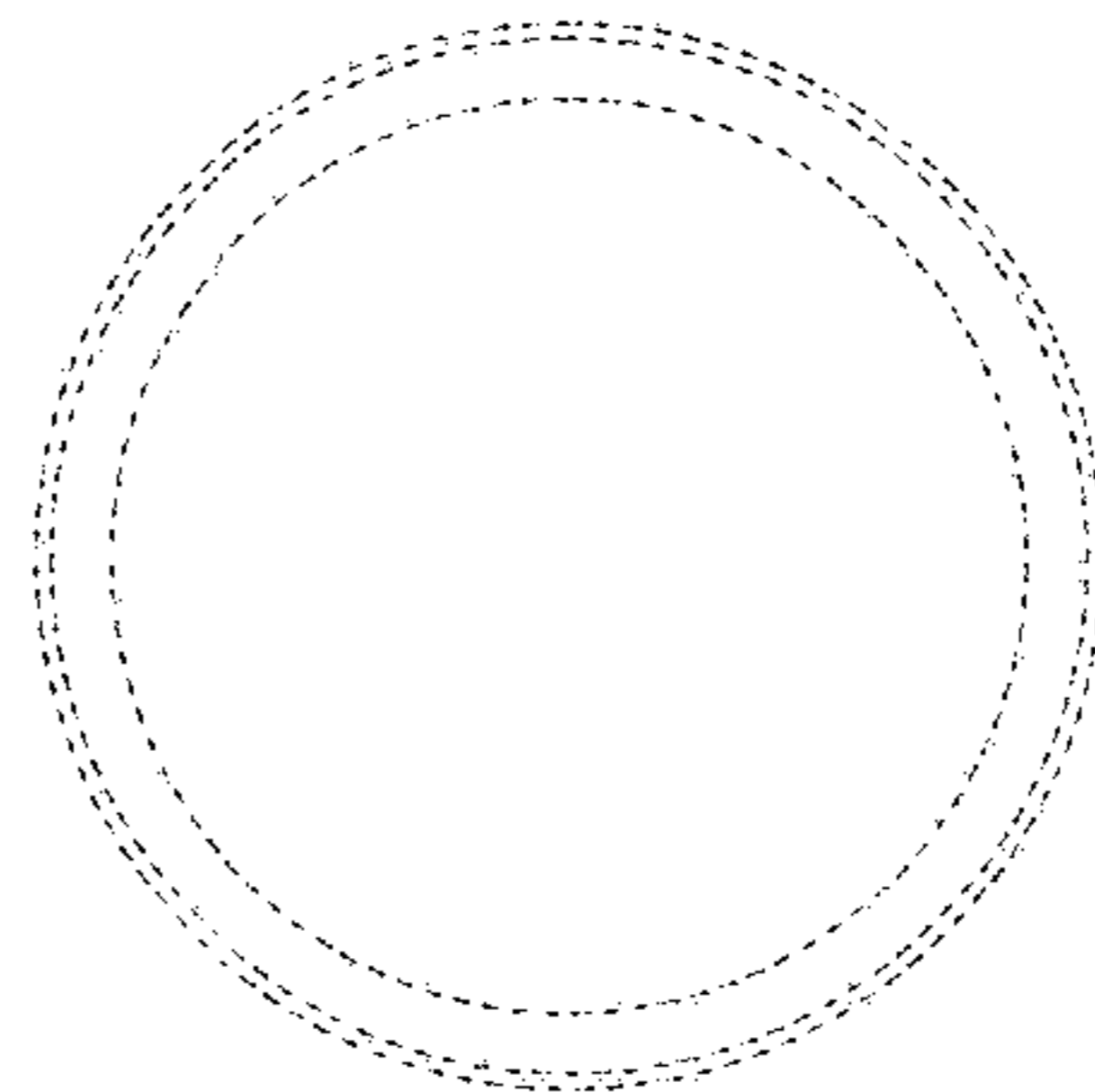

FIG. 4

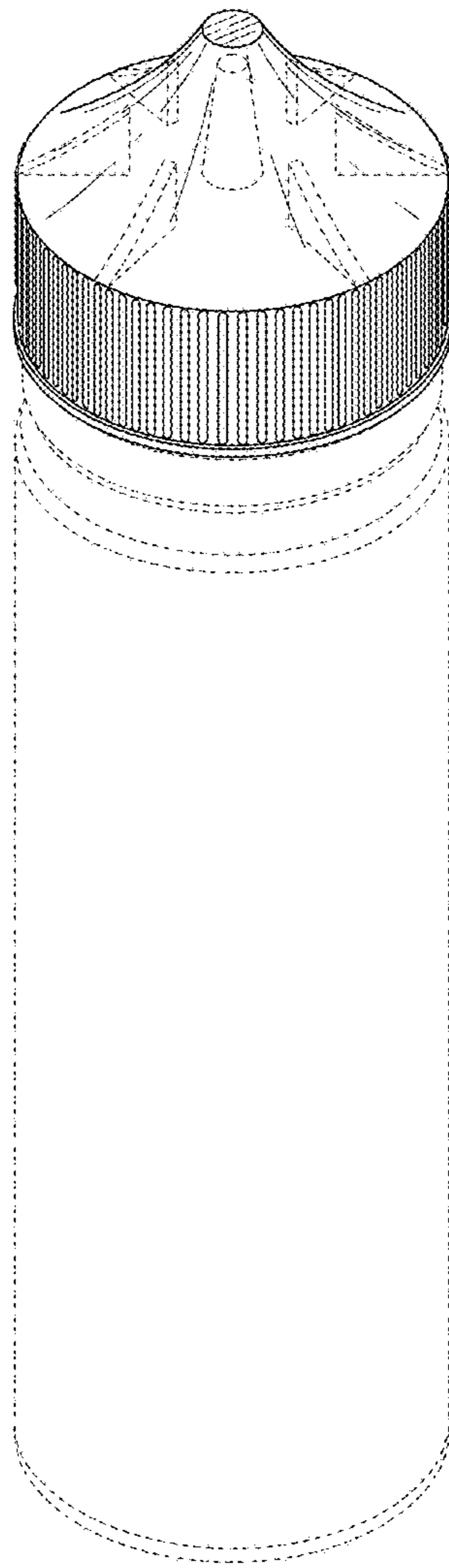

FIG. 5

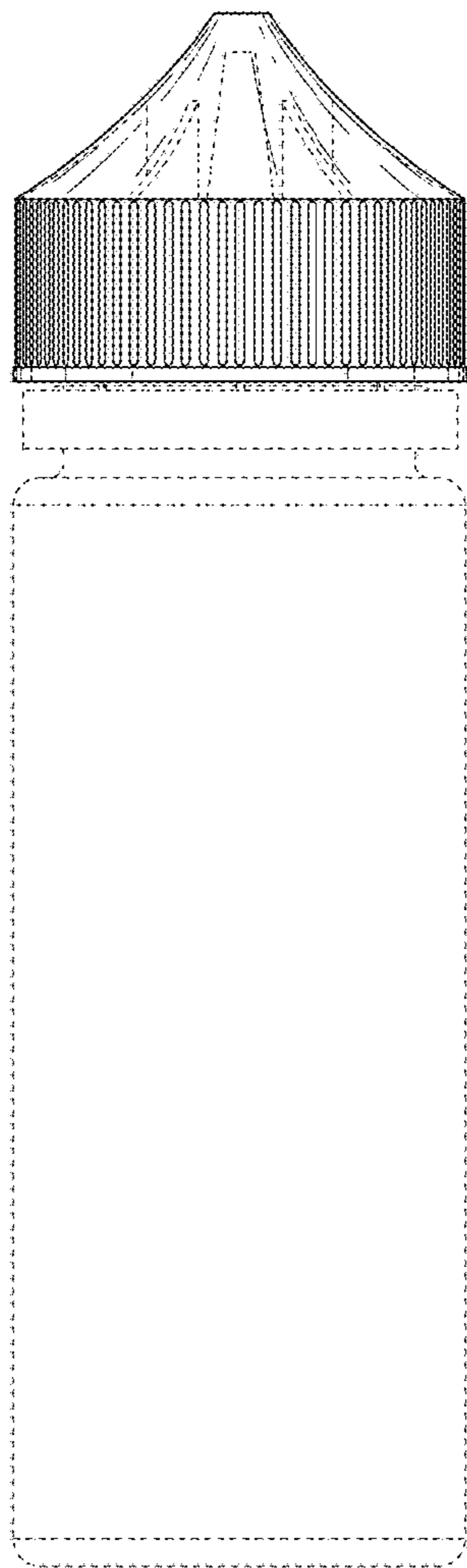

FIG. 6

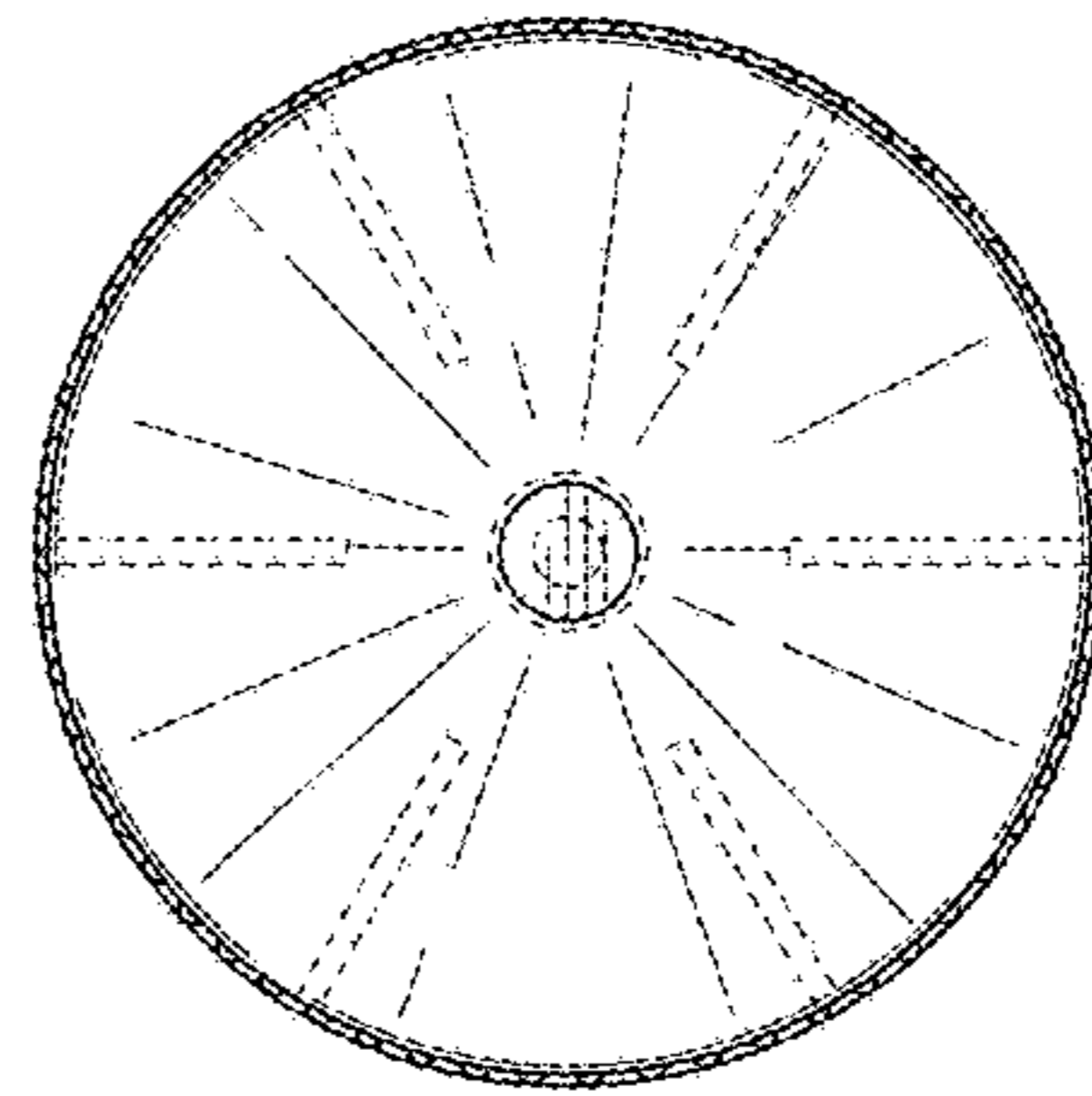

FIG. 7

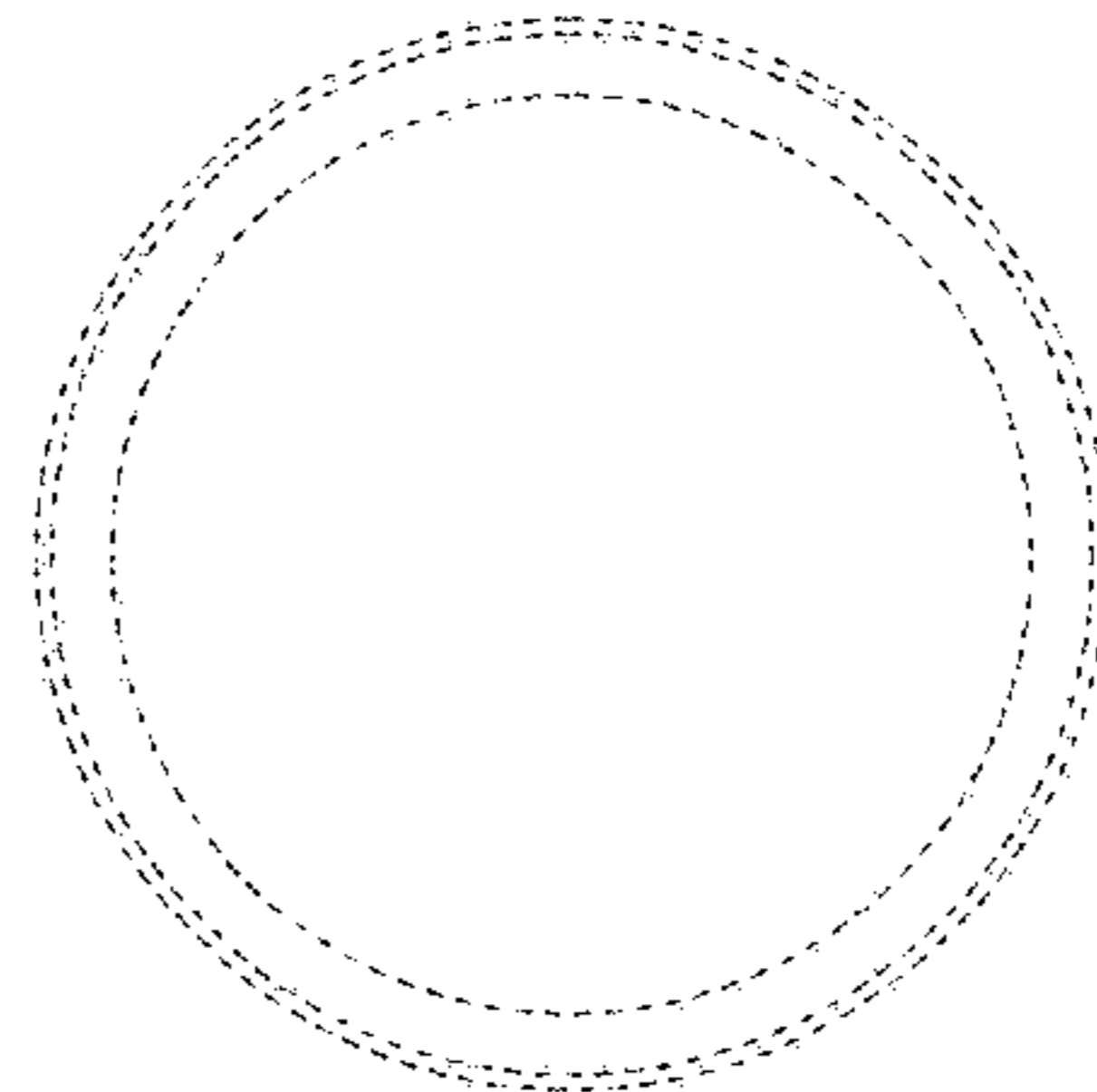

FIG. 8

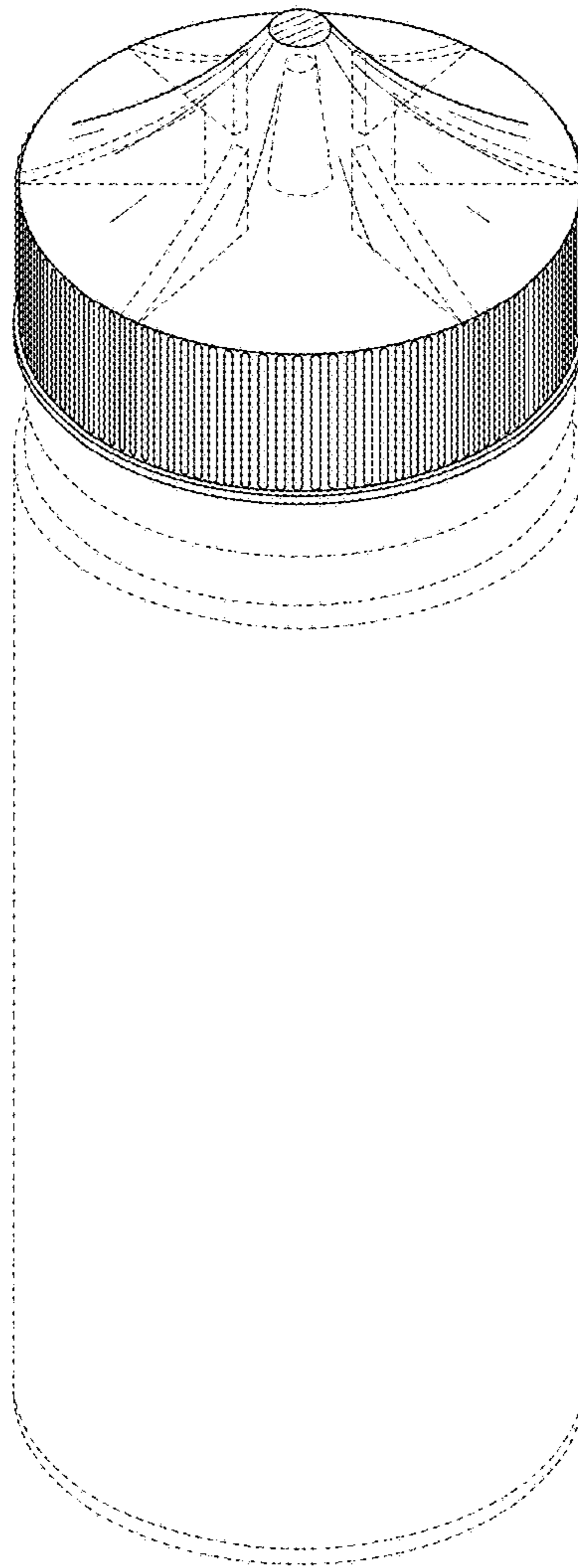

FIG. 9

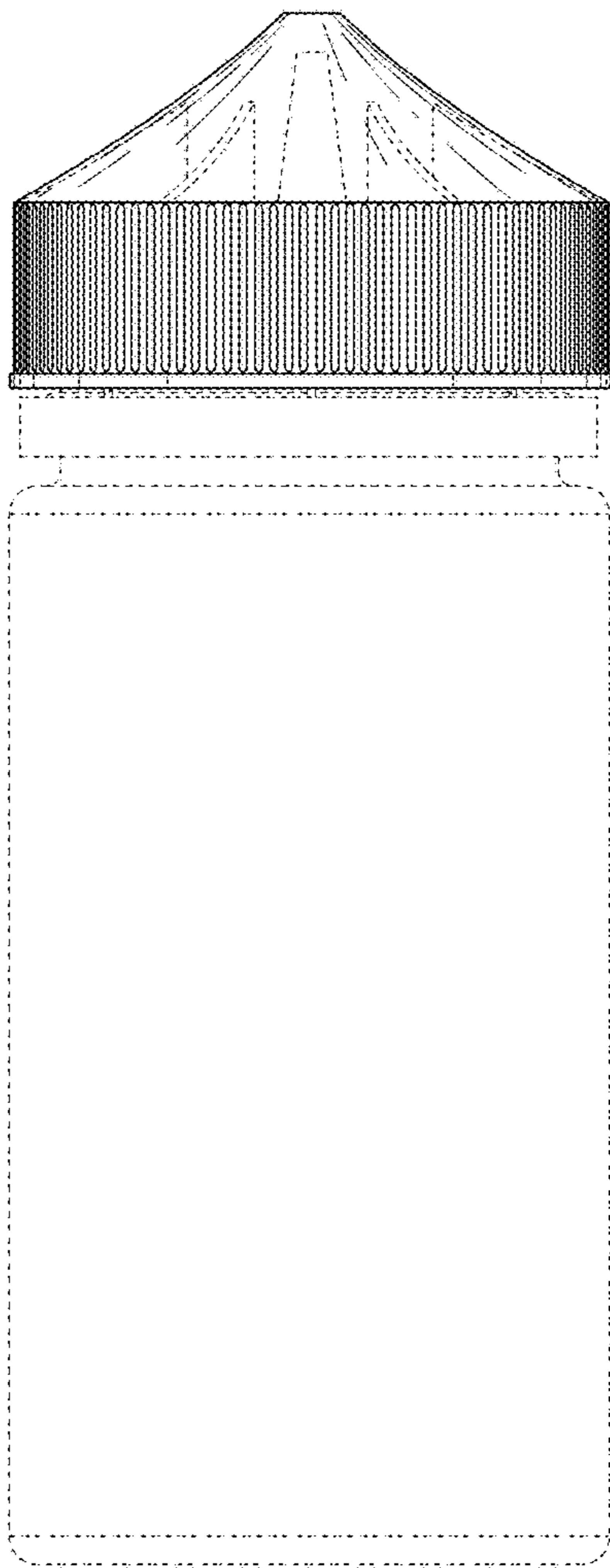

FIG. 10

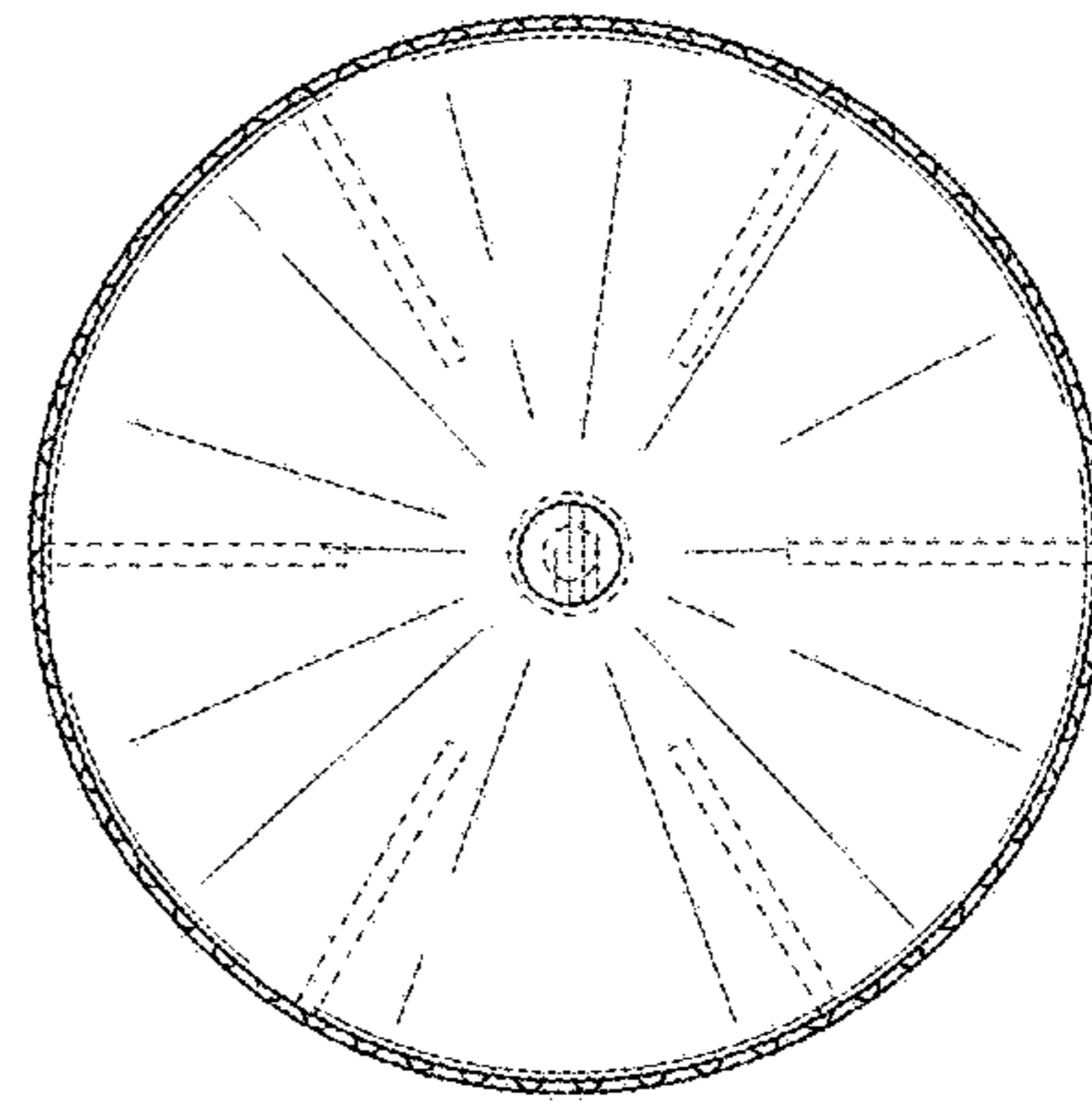

FIG. 11

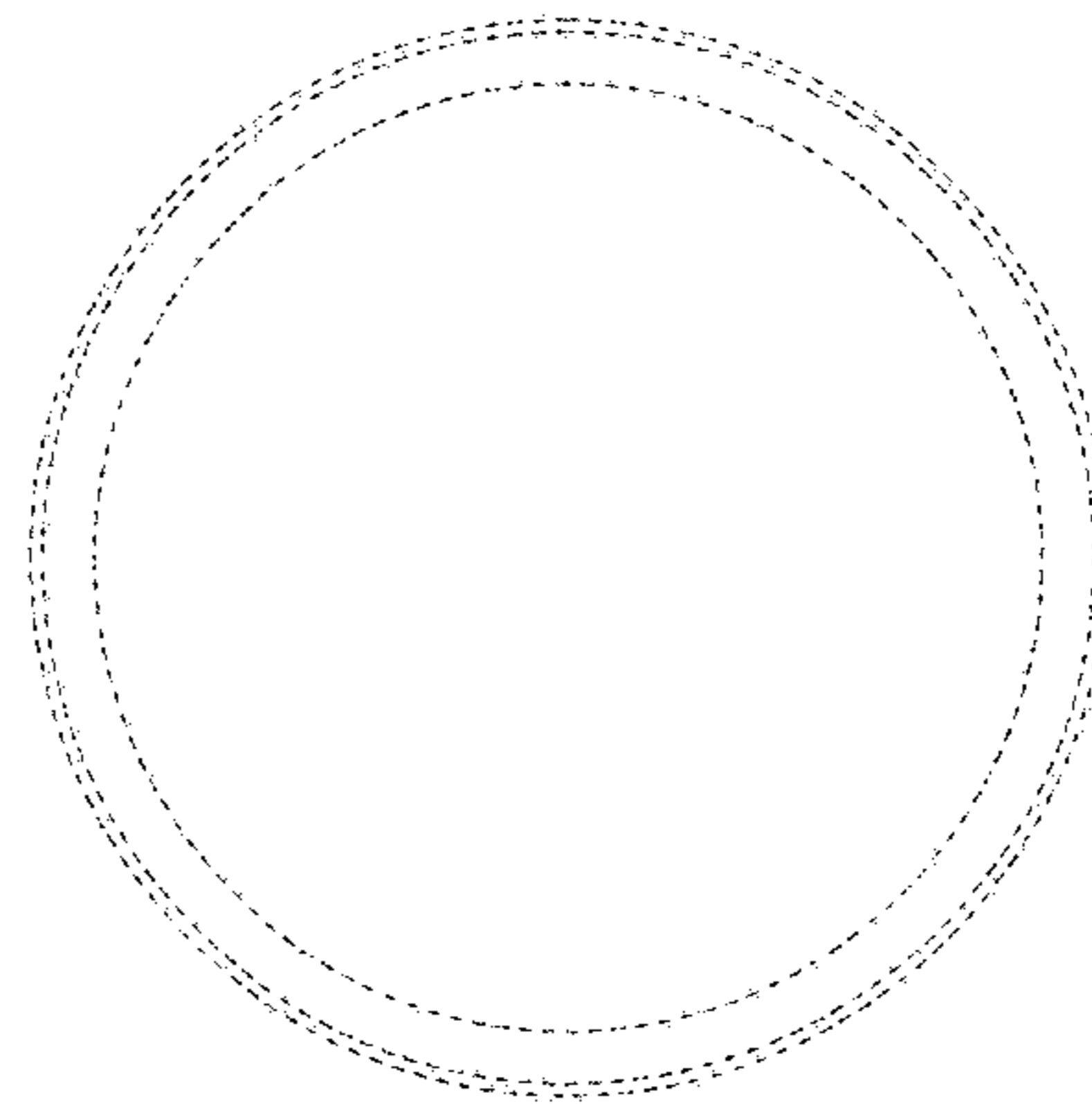

FIG. 12



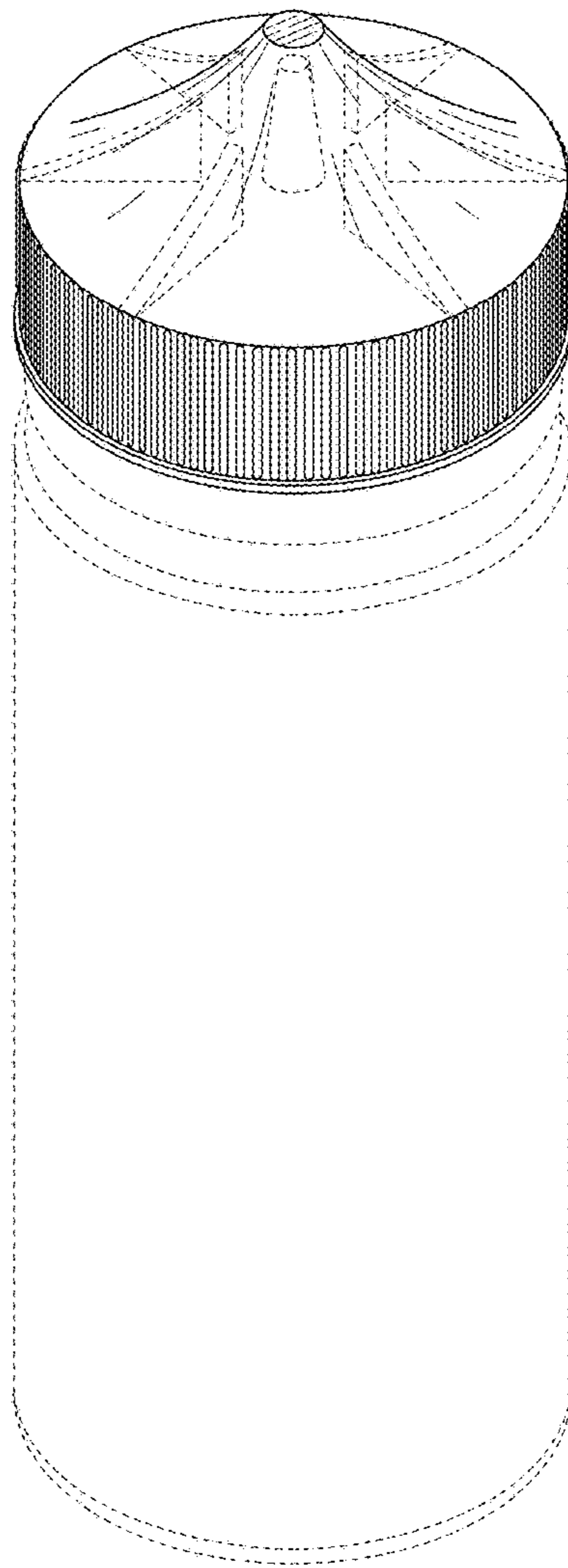

FIG. 13

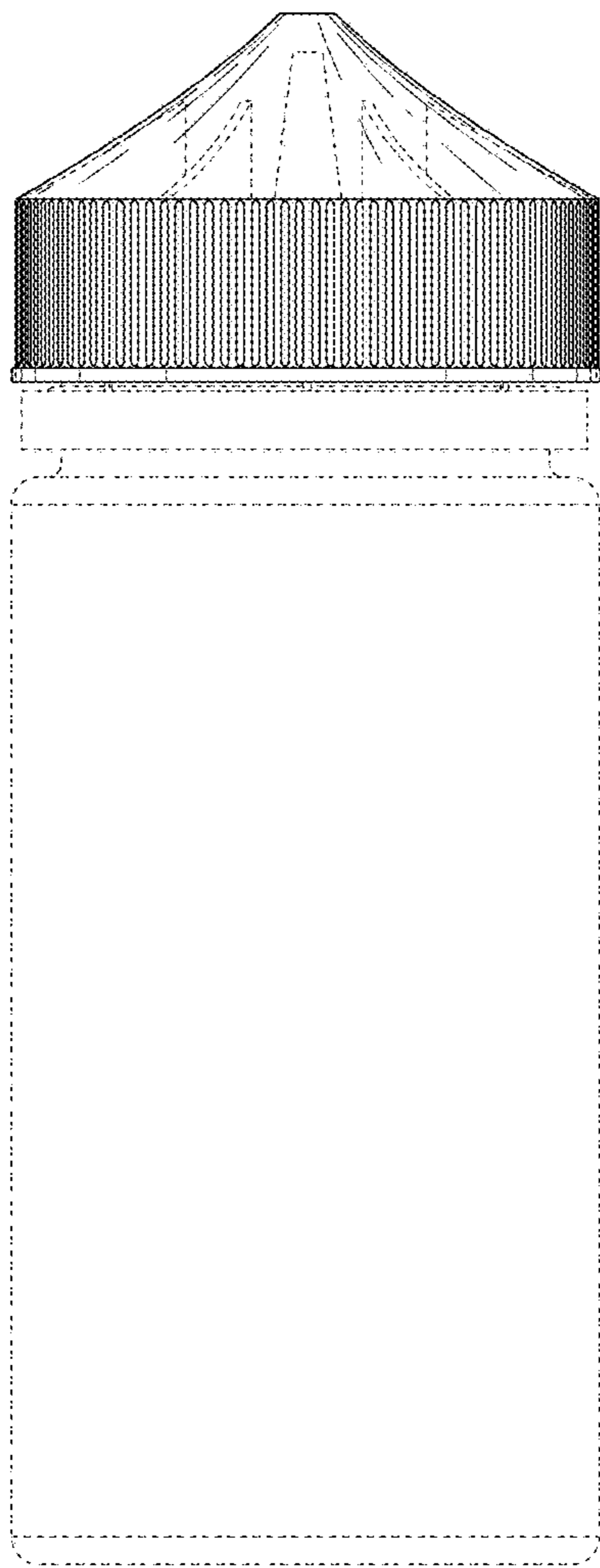

FIG. 14

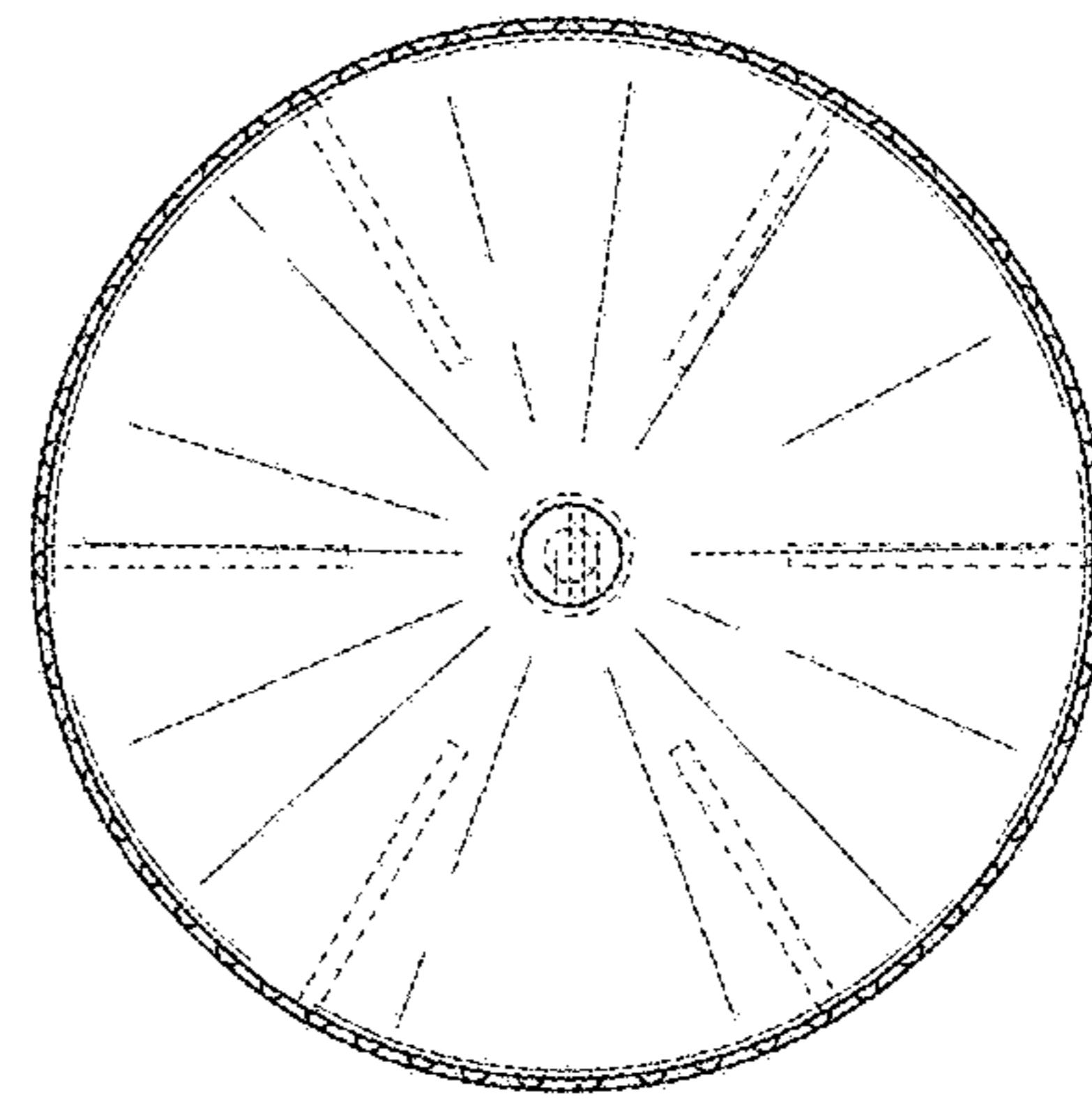

FIG. 15

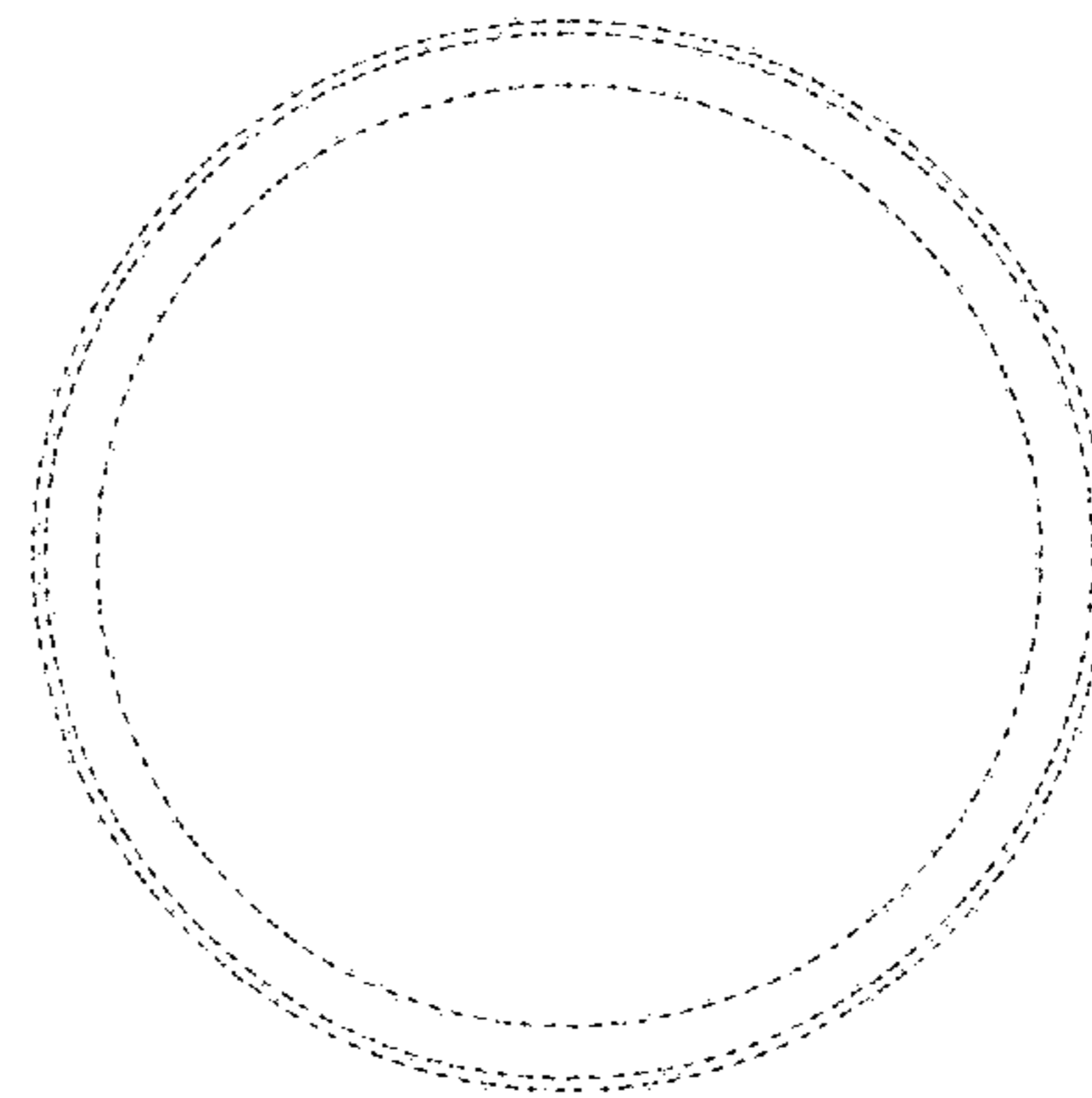

FIG. 16