



US00D859921S

(12) **United States Design Patent**  
**Schmidt et al.**

(10) **Patent No.:** **US D859,921 S**

(45) **Date of Patent:** **\*\* Sep. 17, 2019**

(54) **BEVERAGE BOTTLE**

(71) Applicants: **Justin Schmidt**, Trabuco Canyon, CA  
(US); **Carl Jarecki**, Costa Mesa, CA  
(US)

(72) Inventors: **Justin Schmidt**, Trabuco Canyon, CA  
(US); **Carl Jarecki**, Costa Mesa, CA  
(US)

(\*\*) Term: **15 Years**

(21) Appl. No.: **29/642,697**

(22) Filed: **Apr. 1, 2018**

(51) **LOC (12) Cl.** ..... **07-01**

(52) **U.S. Cl.**  
USPC ..... **D7/511**; D9/529; D9/516

(58) **Field of Classification Search**  
USPC ..... D7/509, 510, 511, 523, 533, 536, 538,  
D7/543, 300; D9/763, 764, 772, 516,  
D9/529, 549  
CPC ..... A47G 19/22; A47G 19/2205; A47G  
19/2211; A47G 19/2216; A47G 19/2272;  
A47G 19/2288; A45F 3/16; A47J 43/27;  
B65D 41/04; B65D 41/56; B65D 43/02;  
B65D 47/08

See application file for complete search history.

(56) **References Cited**

**U.S. PATENT DOCUMENTS**

D618,508 S \* 6/2010 George ..... D7/319  
D752,391 S \* 3/2016 Hatherell ..... D7/510

D781,150 S \* 3/2017 Zoppas ..... D9/500  
D806,568 S \* 1/2018 Chen ..... D9/719  
D814,931 S \* 4/2018 Alima ..... D9/504  
D823,641 S \* 7/2018 Bodum ..... D7/510  
D825,269 S \* 8/2018 Fu ..... D7/510  
D839,673 S \* 2/2019 Meyers ..... D7/510  
2015/0034584 A1 \* 2/2015 Renner ..... B29C 49/08  
215/43

\* cited by examiner

*Primary Examiner* — Derrick E Holland

*Assistant Examiner* — Andrew Kerr

(57) **CLAIM**

The ornamental design for a beverage bottle, as shown and described.

**DESCRIPTION**

FIG. 1 is a front perspective view of a beverage bottle, showing our new design;  
FIG. 2 is a back view thereof;  
FIG. 3 is a front view thereof;  
FIG. 4 is a right view thereof;  
FIG. 5 is a left side view thereof;  
FIG. 6 is a top view thereof; and,  
FIG. 7 is a bottom view thereof.

**1 Claim, 7 Drawing Sheets**

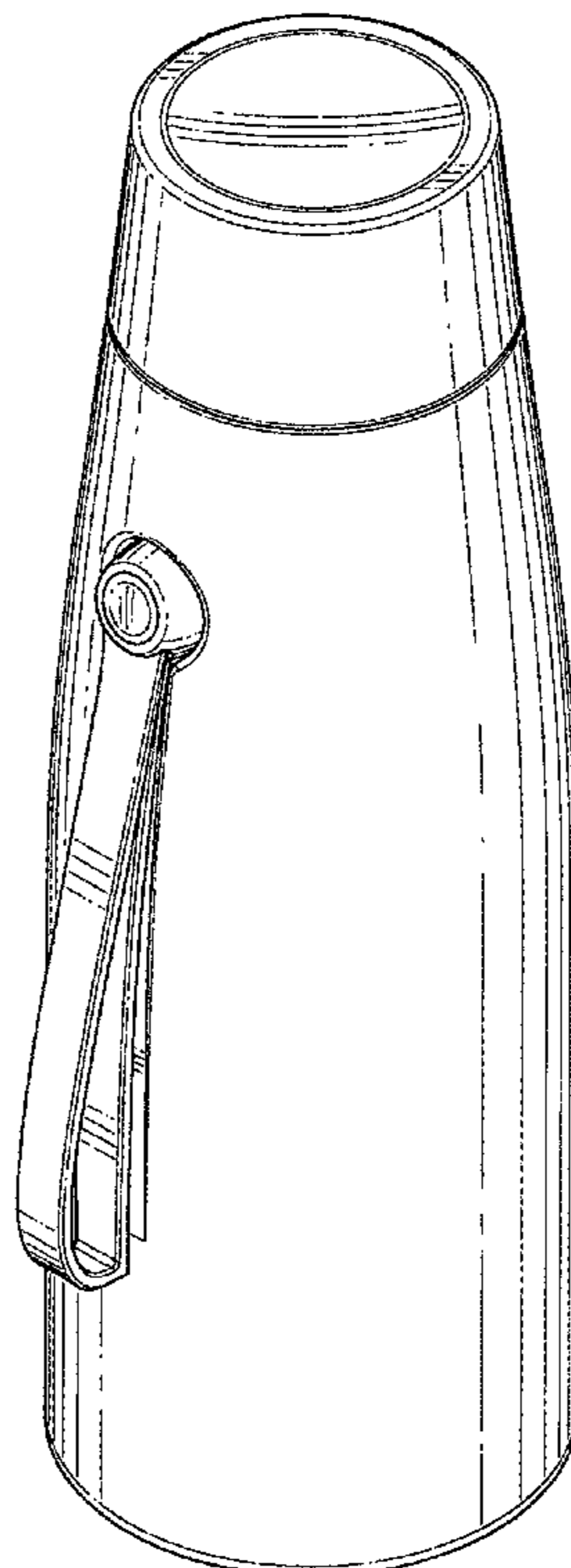

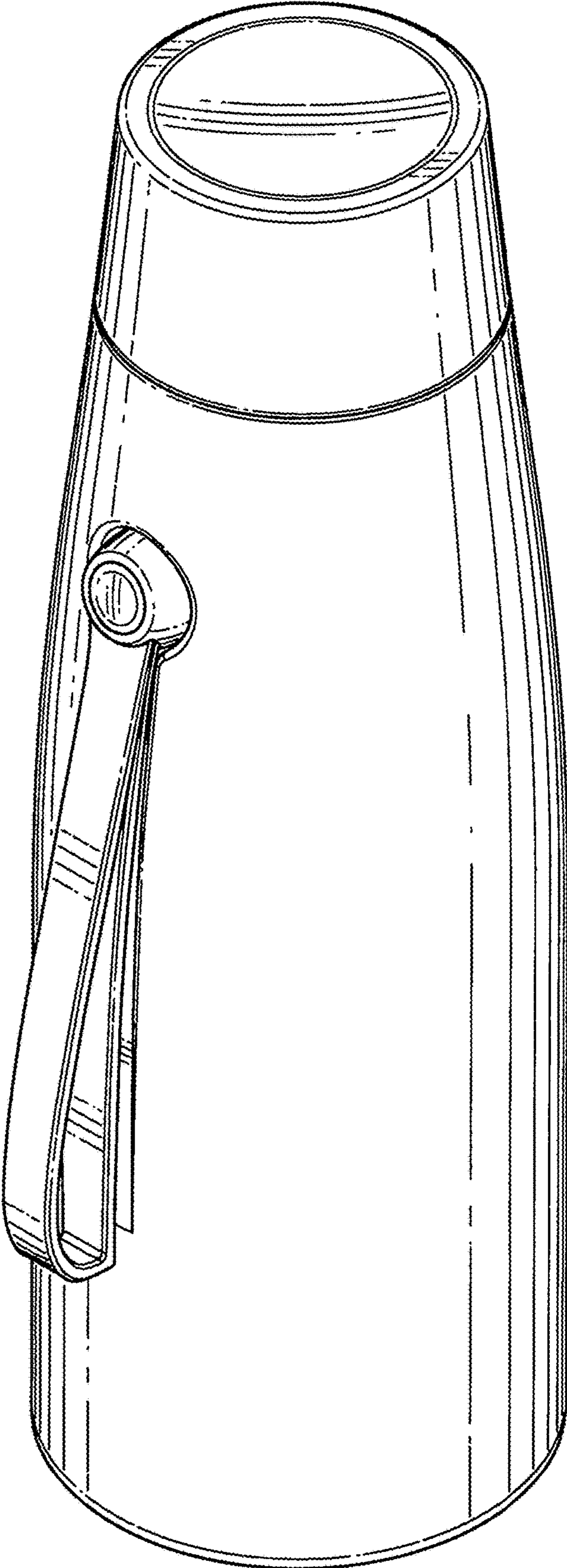

FIG. 1

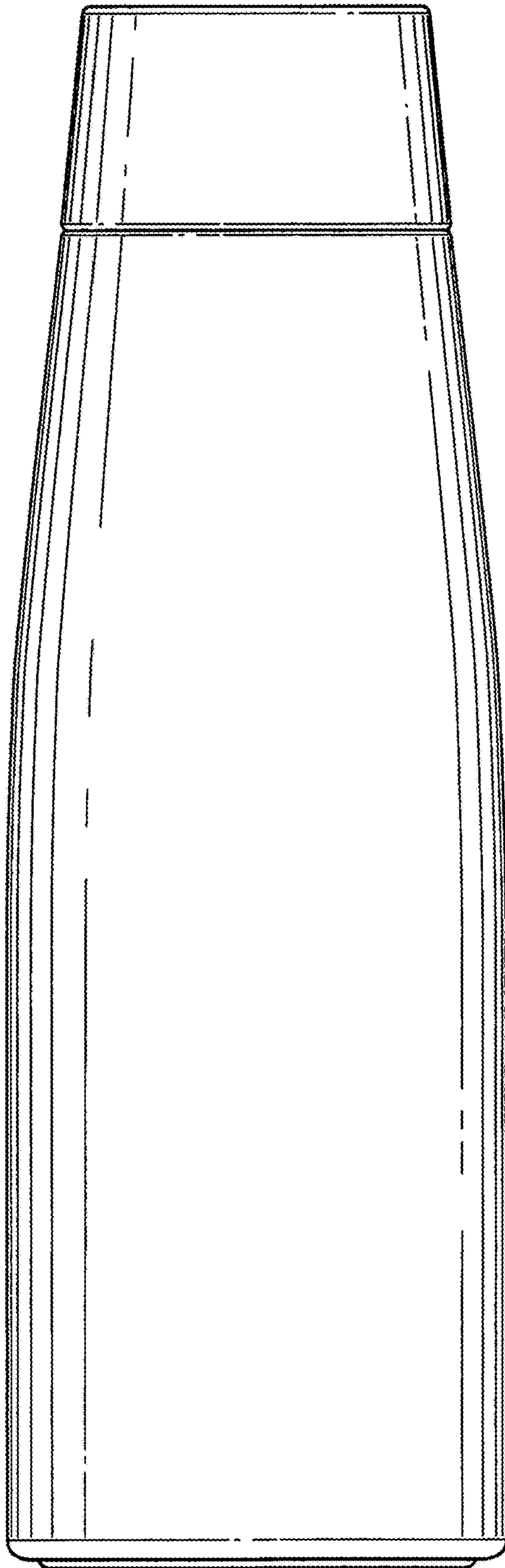

FIG. 2

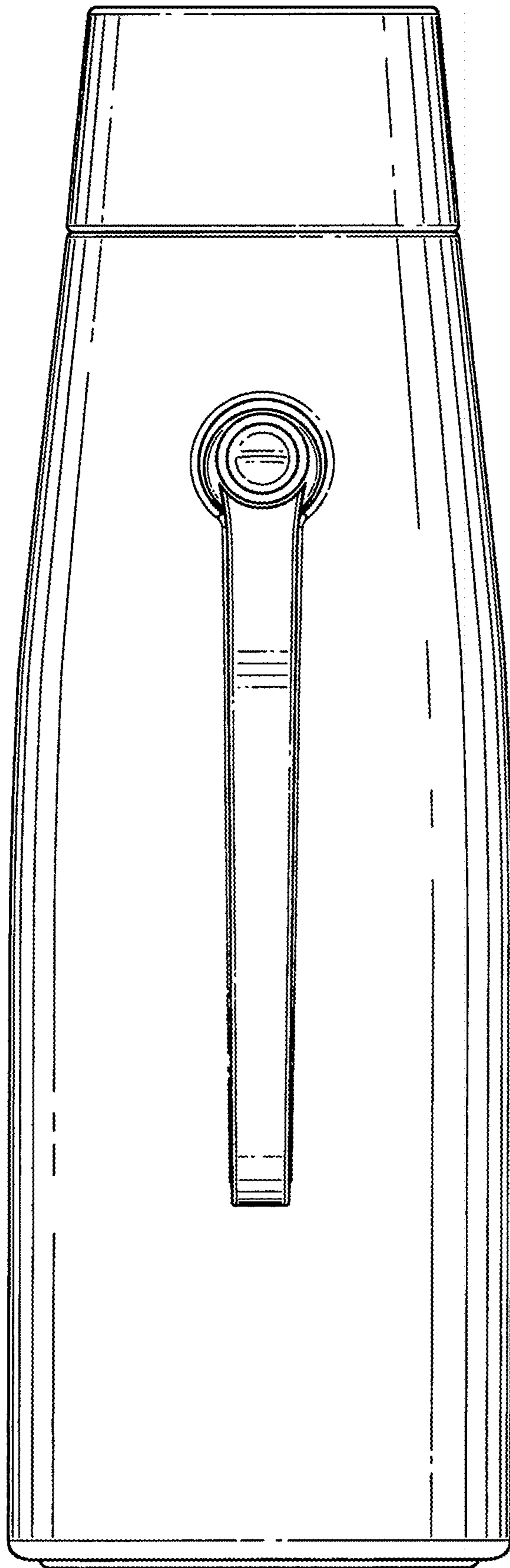

FIG. 3

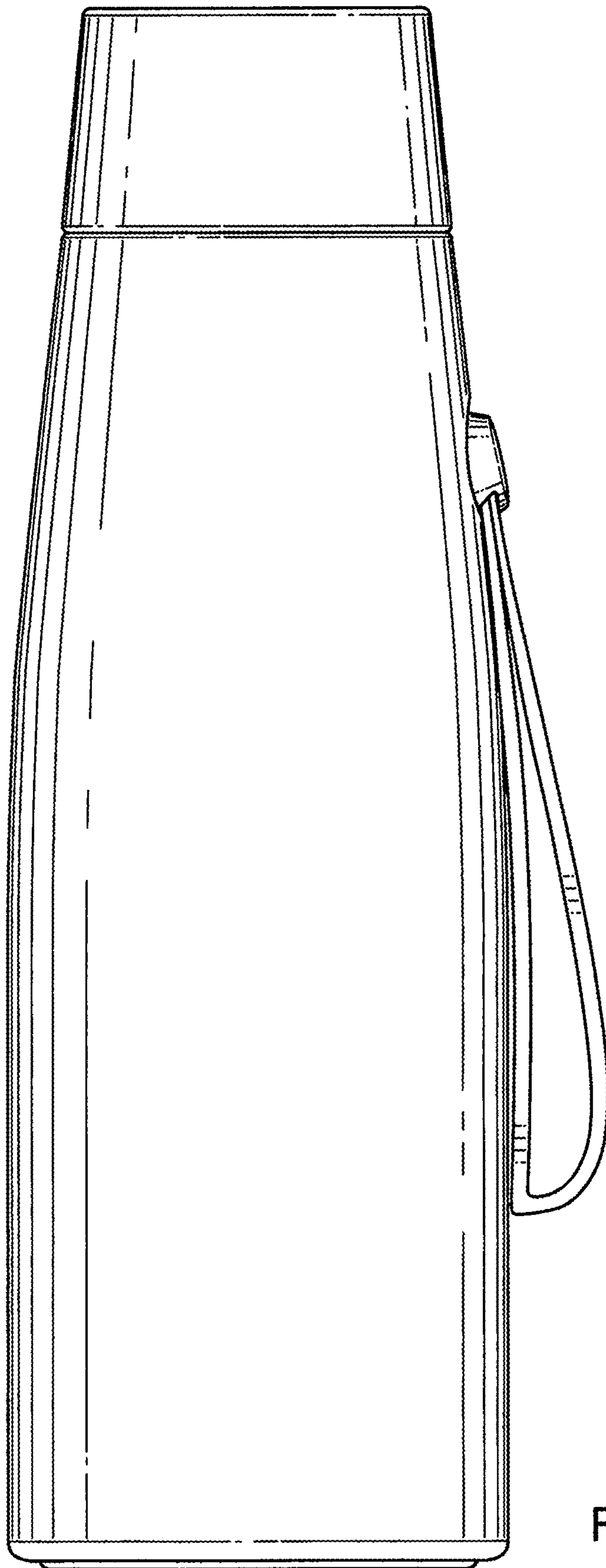

FIG. 4

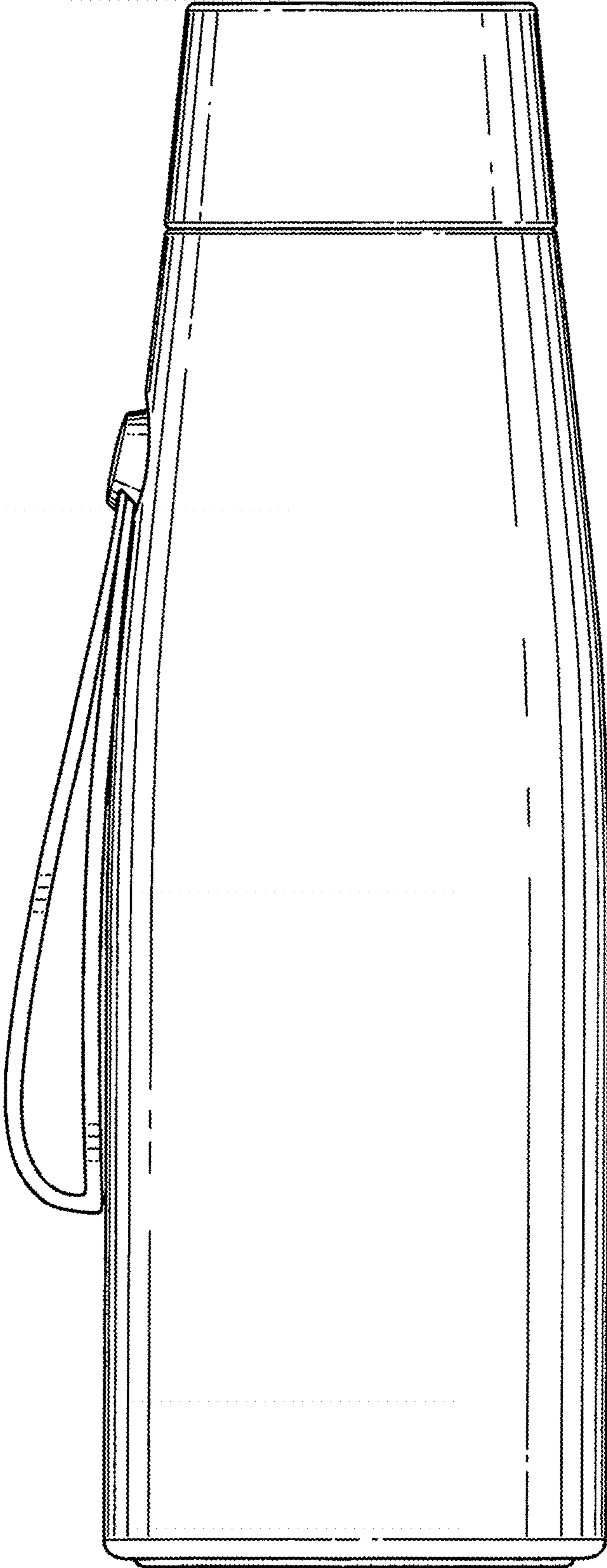

FIG. 5

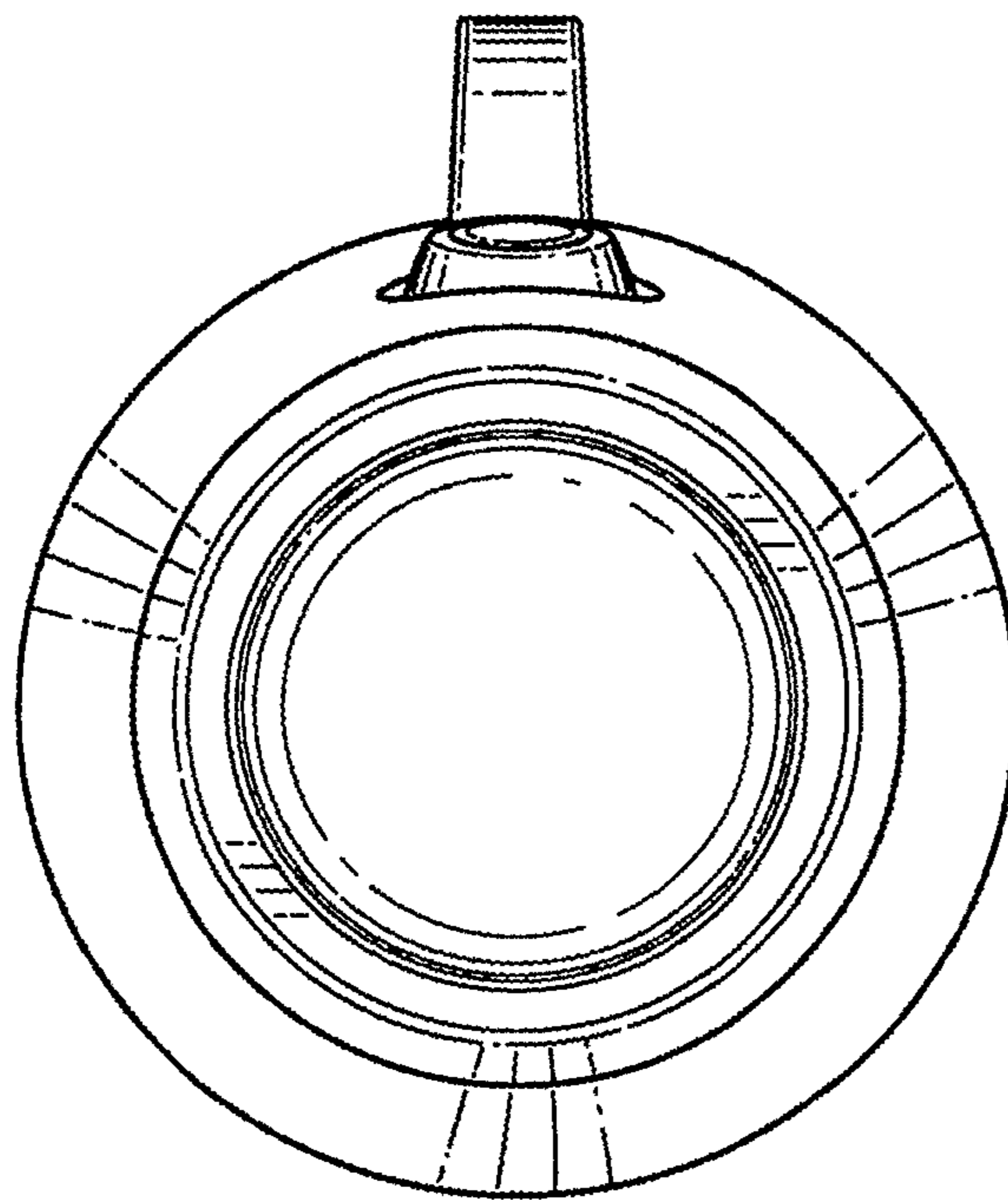

FIG. 6

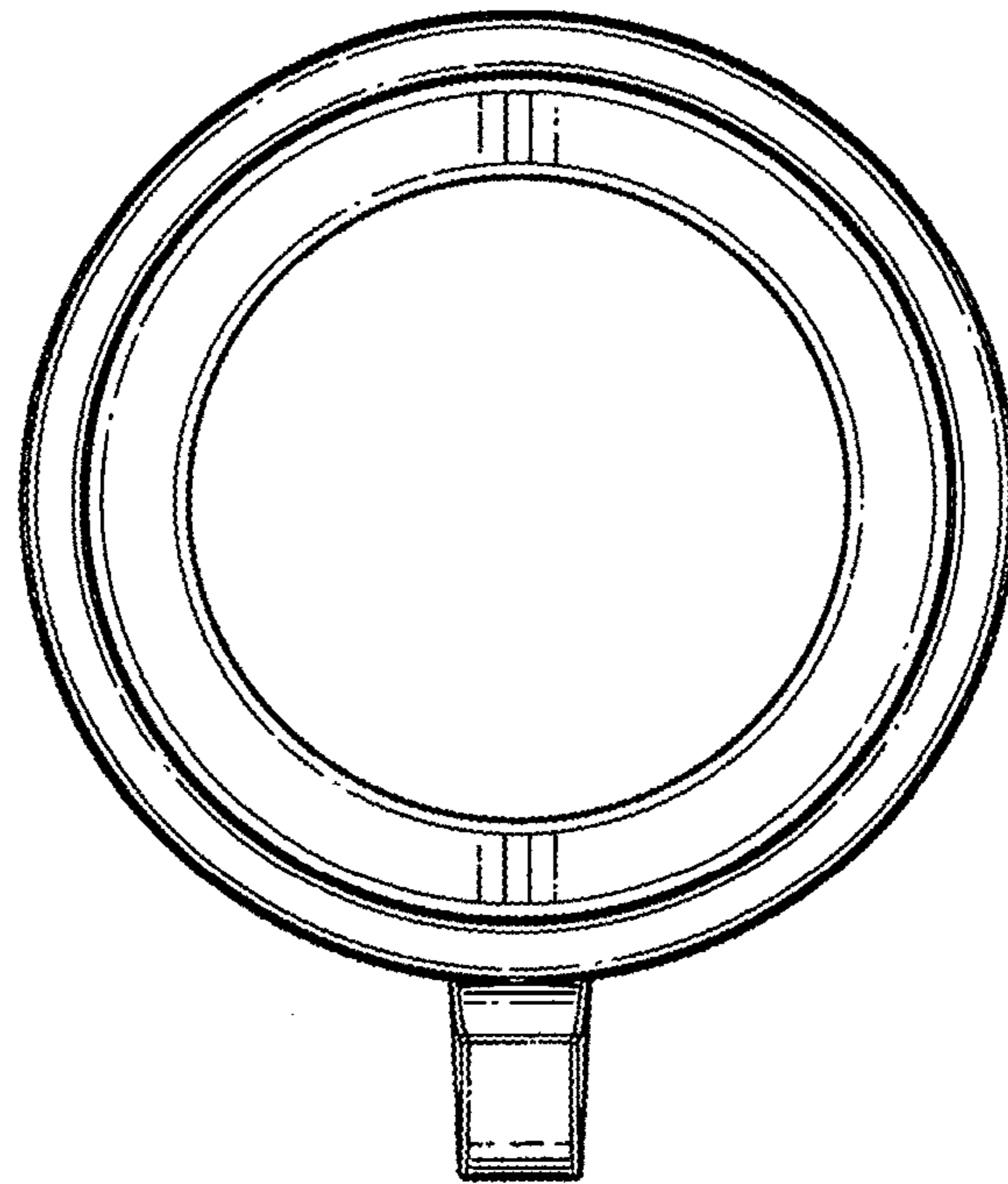

FIG. 7